

VICTA

Not for
Reproduction

Victa Lawnmower Assembly and Owner's Manual



WARNING! Read this manual before operating your VICTA Lawnmower.



IMPORTANT INFORMATION

Labels

The following warning labels are attached to your mower on purchase. Please read before discarding.



2 Stroke Label

Victa 2 Stroke Engine
Fuel Oil Ratio 25:1 = 200ml of Oil for 5 Litres of Fuel

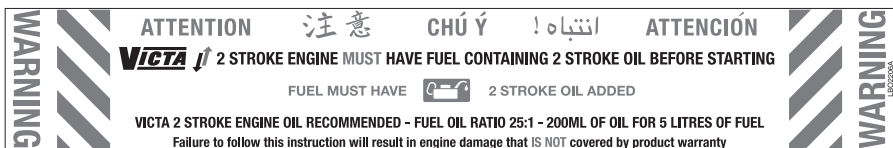

Victa Formula V 2 Stroke High Performance Motor Oil (fuel oil ratio 50:1)
100ml of Oil to 5 Litres of Unleaded Fuel.

PLEASE NOTE 50:1 OIL RATIO IS ONLY WITH
APPROVED "VICTA FORMULA V 2 STROKE OIL"



4 Stroke Label

Victa V40 Engine
Engine must have 600ml off S.A.E. 30 Oil placed in the Sump Before Starting

Briggs & Stratton Engine
Engine must have 600ml off S.A.E. 30 Oil placed in the Sump Before Starting

Honda Engine
Engine must have 550ml of S.A.E. 30 Oil placed in the Sump Before Starting



Dust Cap (4 Stroke Briggs & Stratton Mowers Only)

Removal of Blue Dust Cap









Dispose of dust cap from under fuel cap before initial filling (if fitted)
DO NOT REPLACE

CONTENTS & SYMBOLS



Table of Contents

	Important Notes	1
	Unit Details	
	Safety & Handling	2
	Safety Instructions	
	Hazards	
	Personal Safety Equipment	
	Assembly Procedures	5
	Grasscatcher	
	Handle Knobs/Toggles	
	Attaching Handles	
	Mulching Plug	
	Aerogrip Handle Assembly	
	Assembly Procedure	
	Attaching The Remote Air Filter Housing	
	Attaching Battery (Keystart models only)	
	Operating Instructions	16
	Mowing & Mulching Tips	
	Starting & Stopping	
	Self Propelled	
	Maintenance & Care	18
	Cleaning	
	Blade Replacement	
	Remote Air Filter Maintenance	
	Replacing Air Filters	
	- Aerogrip Handles	
	Keystart Battery	
	Maintenance Chart	
	Questions & Answers	24
	Troubleshooting	
	Warranty	25
	Warranty Conditions	



IMPORTANT NOTES

Congratulations on your purchase of a top quality Victa lawnmower. This instruction manual will aid in the assembly, operation and maintenance of your new lawnmower.

Please read carefully to ensure safety and the long life of your product.



Do not operate the unit before reading this manual.

Do not operate before reading the 'Engine Manual'.

Keep this instruction manual in a safe place for future reference or if service is required on your unit.

Please read the 'Warranty' section carefully

Unit Details

When unpacking the unit, ensure that all component parts listed below have been provided. Should there be a problem, notify the place of purchase.

You should find the following enclosed:

- 1 VICTA lawnmower
- 1 Unassembled grasscatcher and assembly kit (Catcher models)
- 1 Engine manual
- 1 Mulching plug (Mulch or Catch models only)
- 1 Lower handles and accessories pack (Customer assembled models only)



Safety Instructions

Transporting the mower

- Turn the engine off, by moving the throttle lever to the 'STOP' position and switching the fuel tap off (where fitted).
- Disconnect the spark plug lead and wedge it between the cylinder head fins.
- Do not transport the mower in a vehicle if there is fuel in the fuel tank.
- Remove the starter key and disconnect the battery (Keystart models only).

Before using the mower

- Read the separate 4 Stroke or 2 Stroke engine manual.
- **For the 4 stroke engines - (Briggs & Stratton 600ml of SAE 30) and (Honda 550ml of SAE 30) oil must be placed in engine sump before starting engine. Failure to do so will cause engine damage and will void engine warranty.**
NOTE: Please refer to engine manufacturers manual.
- **For 2 Stroke engines see manual for petrol/oil fuel mixture information.**
- Do not start the mower until you have studied the instruction manual.
- Know the mower controls. Learn how to stop the engine quickly in an emergency by moving the throttle to the 'STOP' position.
- Before using the mower, ensure that the blade assembly is not worn or damaged. Always replace worn or damaged blades and bolts in sets to preserve correct balance. Damaged or worn blades and bolts are major hazards. Use genuine VICTA spare parts only.
- **Please note blades may be tucked under blade disc for safety and transport reasons before use. Once the engine is started they will relocate themselves for cutting.**
- Check all fasteners regularly. Always ensure the mower is in a safe operating condition.
- Check for grass build up around the engine and muffler which may cause overheating and/or a fire hazard.
- Do not start the engine unless the rear flap and/or grasscatcher are securely in position.

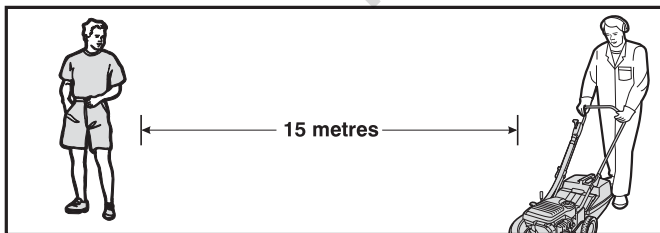

Operating the mower

- Do not mow while people or pets are in the vicinity of the mower or within the mowing area. Ensure that bystanders are a minimum of 15 metres away.
- Do not mow in bare feet or open shoes. Wear long trousers and heavy footwear.
- Make sure the lawn is clear of sticks, stones, bones, wire and debris before mowing.



SAFETY & HANDLING

Safety Instructions

These could be thrown by the blades and cause injury or damage.

- Start the engine carefully with feet well clear of blades. Do not tilt the mower when starting the engine.
- Stop the engine whenever you leave the mower, even for a moment.
- Mow only in good daylight.
- Keep hands and feet away from rotating parts beneath mower when engine is running.
- Do not over speed the engine or alter the governor settings. Excessive engine speed is dangerous and shortens mower life.
- **Never lift, carry or tilt the mower when the engine is running.**
- Stop the engine before pushing the mower across gravel, paths or roads. Stop the engine before the mower leaves the lawn.
- Stop the engine before adjusting the cutting height.
- Mow across the face of a slope, never up or down. Use extreme caution when changing direction on a slope. Do not mow on excessively steep slopes.
- Never mow by pulling the mower towards you. You may slip and pull the mower on top of your feet. Never mow grass while walking backwards.
- Walk with the mower, never run.
- The safety distance determined by the guiding handles must be maintained at all times.
- At the conclusion of mowing, always turn the mower off using the throttle lever then turn fuel tap off (where fitted).

Maintaining the mower

- If the mower begins to vibrate abnormally, or if it strikes a foreign object - STOP the engine, disconnect the spark plug lead from the spark plug and carefully wedge it between the cylinder fins. Inspect the mower and blades for any damage.
- Replace worn or faulty mufflers as they adversely affect engine performance and increase emissions.
- VICTA recommends that all maintenance, repair and inspection work be carried out by a VICTA Authorised Service Centre.
- Store the mower in a well ventilated area, away from any naked flames such as those found in hot water heaters.

Refuelling the mower

- Refuel the mower outdoors only.
- Do not smoke when refuelling the engine. Never add fuel or remove the fuel cap while the engine is running or hot. If fuel is spilt, do not start the engine. Move the mower away from the area of the spill. Do not create any source of ignition until fuel vapours have dissipated.
- Store fuel in a cool place and in a container specifically designed for the purpose. VICTA supplies a 5 litre fuel can as an optional extra. Plastic containers are unsuitable, except those specifically designed to hold fuel.

SAFETY & HANDLING



Hazards

The following safety precautions must be strictly observed to avoid the risk of damage or personal injury.

- Do not smoke while operating or refuelling the mower. Never add fuel or remove the fuel cap while the engine is running or hot. If the fuel is spilt, do not start the engine. Move the mower away from the area of the spill. Do not create any source of ignition until the fuel vapours have dissipated.
- Check all fasteners regularly. Always ensure that the mower is in safe operating condition. Use genuine spare parts only.
- Do not operate the mower in confined spaces where exhaust fumes (carbon monoxide) can collect.
- Stop the engine whenever you leave the mower, even if only for a moment.
- Stop the engine when emptying the grasscatcher. Never try to clear grass from inside the mower while the engine is running.
- Never lift, carry or tilt the mower when the engine is running.
- Bystanders must be at least 15 metres away during operation of the mower, as rocks and other materials may be thrown at high velocities. Switch the unit off immediately if approached.
- Never use the mower unless the grasscatcher and/or the rear flap are correctly assembled and fitted.

Personal Safety Equipment

Recommended safety equipment to wear when working with your lawnmower:



A set of ear muffs.



A pair of protective gloves.



A pair of safety boots.



Eye protection.



ASSEMBLY PROCEDURES

Grasscatcher - hard/solid type

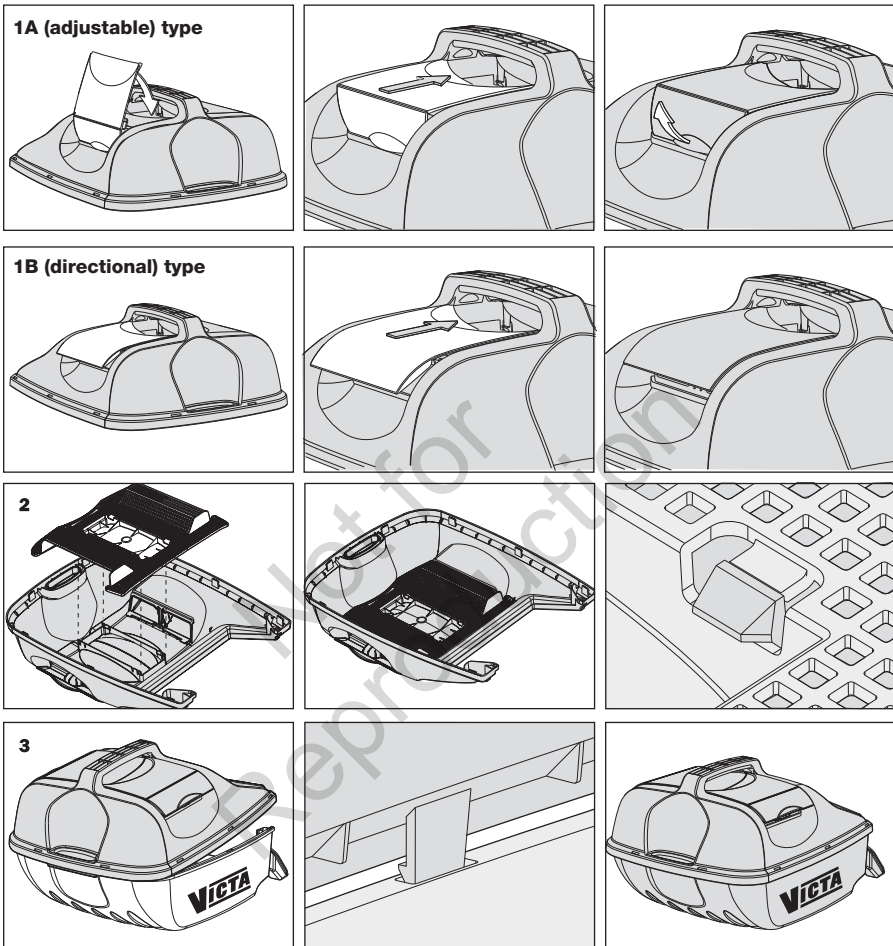

Assembling the grasscatcher

- 1 Assemble the adjustable covers 1A or directional covers 1B to the top half of the grasscatcher.
- 2 Locate the centre protrusion of the mesh into the centre hole on the inside of the grasscatcher top, ensuring the curved edge of the mesh faces the rear handle. Firmly push the mesh into the top half of the grasscatcher, making sure that the four snap hooks engage securely.
- 3 Loosely locate the rear handle areas of the top and bottom grasscatcher halves then loosely locate the side edges. Check that all eight hooks from the top half are loosely located in the slots on the bottom half then firmly push the two halves together over each snap hook. Check that all of the snap hooks have engaged securely.
- 4 Tighten the two screws fitted to the front of the grasscatcher.

ASSEMBLY PROCEDURES



Grasscatcher - fabric type

Fabric Grasscatcher Assembly Instructions

There are 6 edges (A, B, C, D, E & F) which require to be clipped into the frame.

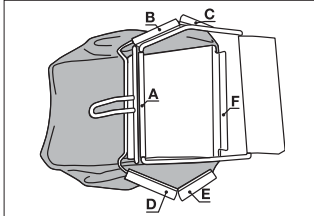

1 - Insert metal frame into fabric grasscatcher.

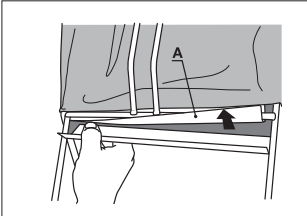

2 - Clip edge A to frame.

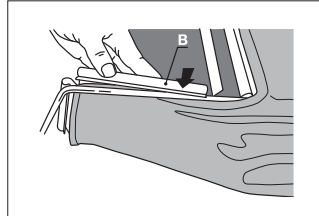

3 - Clip edge B and repeat the process for the opposite edge D.

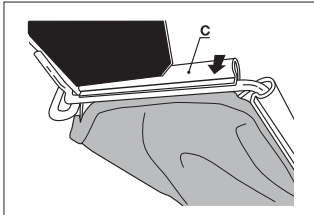

4 - Clip edge C.

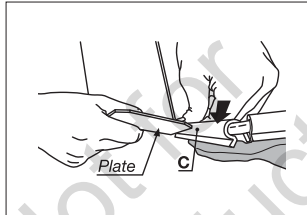

5 - Hold the plate in one hand. Then push edge C through the gap (on edges C and E only).

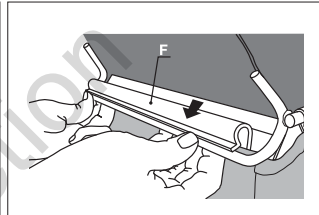

6 - Clip edge F on the underside of the frame.

Grasscatcher - fabric

16in model are fully assembled

Grasscatcher

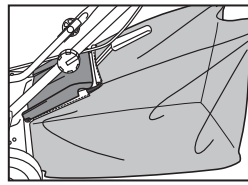
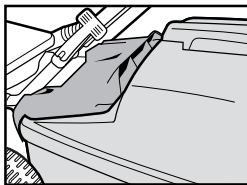
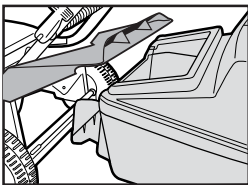

Fitting the grasscatcher

- Stop the engine.
- Raise the rear flap. Locate the grasscatcher tongue over the rear axle and insert the grasscatcher under the rear flap.
- Lower the rear flap to retain the grasscatcher.



ASSEMBLY PROCEDURES

Grasscatcher - 16in model



Fig. 1



Fig. 2

Fitting the Grasscatcher

- Stop the engine.
- Raise the rear flap and hook the grass catcher on the bar at the rear of the mower as shown in figures 1 and 2.
- To remove the grasscatcher, lift the rear flap and grasp the handle on the grasscatcher and unhook from the rear bar.



STOP the engine before fitting or removing the grasscatcher.



Never use the mower unless the grasscatcher and/or the rear flap are correctly assembled and fitted.

Handle Knobs/Toggles

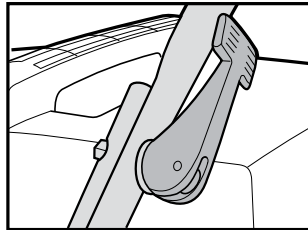
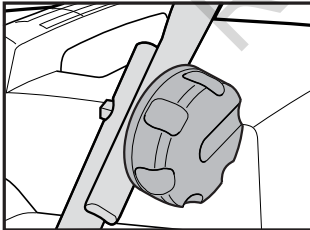

Mowers will have either knobs or toggles to fix the handles in position. Refer to the instruction below which is specific to your particular model.

- Tighten the handle knobs to secure the upper handle to the lower handle.
- Flip the handle toggles to secure the upper handle to the lower handle.
- On some models the knobs/toggles have to be consumer fitted.



When folding or unfolding the handles, ensure that the starter switch lead is not caught or stretched (Keystart models only).

ASSEMBLY PROCEDURES



Handle Knobs/Toggles

Cam Lock Assembly

Note: Ensure cam locks are secure & tight so handles cannot move!

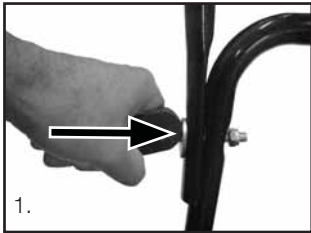

1. Hold locking lever open and push hard against handle, as shown



2. Tighten nut with supplied spanner, as shown

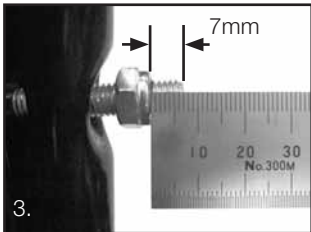

3. Adjust the nut on the bolt and measure 7mm from the top of the bolt to the top of the nut!
Note: This is only a guide as to the location of the nut! If more pressure is required move the nut in 1/2 turn at a time.



4. Lift locking lever into position, as shown
Note: When the locking lever is engaged the upper handle should not rock on the lower loop handle.

5. If locking lever force is not sufficient, repeat steps 3 & 4.

Handle assembly parts (only on self assembled handle)

16in models (Your lawnmower should include a kit with the following parts).

Note: Some models come with straight or comfort grip upper handles.
Some models come with straight or looped lower handles

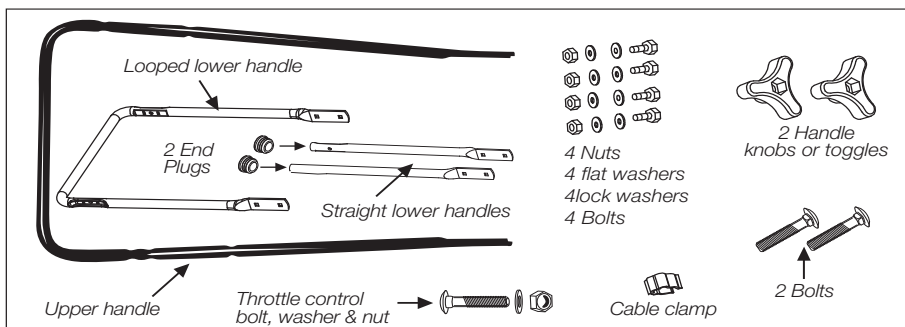



ASSEMBLY PROCEDURES

Attaching the lower handles

Model
All 16in Steel Models

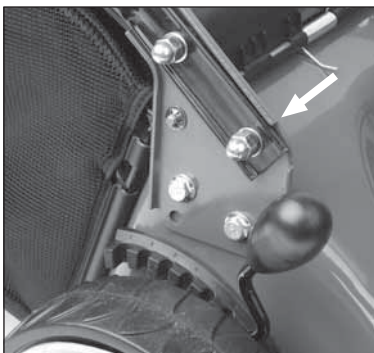

****Disconnect spark plug lead first****

1. Fit one of the bolts through the handle hole from the inside and into the square hole in mounting bracket of the base. place washer then spring washer and secure with nut but do not fully tighten at this stage.
2. Repeat the same step for the remaining three securing bolts.
3. Tighten all four nuts securely.

Attaching upper handle

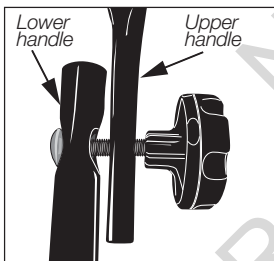

- Attach the upper handles using the knobs/toggles and bolts provided. The knobs/toggles should be on the outside.

Attaching the throttle control

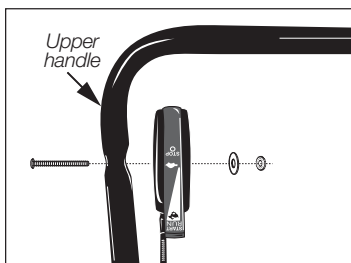

- Attach the throttle control to the inside of the upper handle, so that the lever lifts upward toward the user.

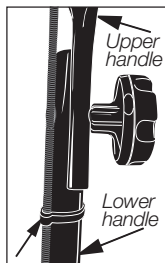

- Secure the throttle cable to the lower handle with the cable clamp supplied.

ASSEMBLY PROCEDURES



Handle assembly parts (only on self assembled handle)

Model

All 18in Steel Models

Your lawnmower should include a kit with the following parts.

Straight lower handle

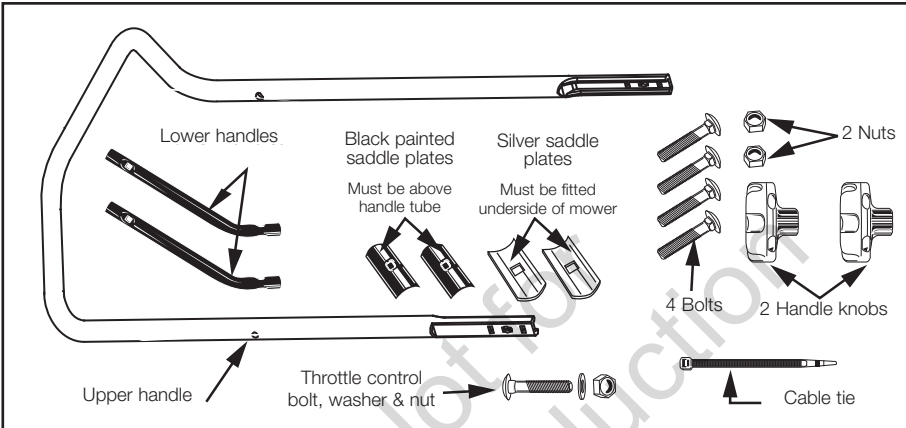

Lower loop handle

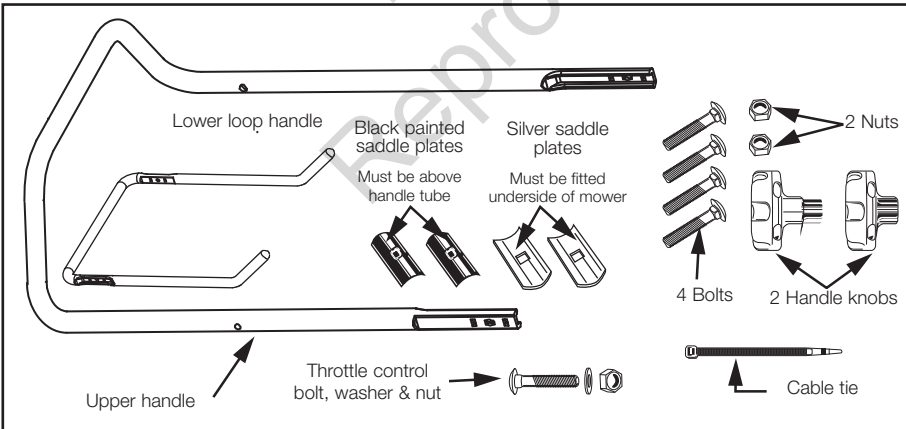

Please Note: Some models come with straight or comfort grip upper handles.
Some models come with straight or looped lower handles.



When folding or unfolding the handles, ensure that the starter switch lead is not caught or stretched (Keystart models only).



ASSEMBLY PROCEDURES

Attaching the lower handles straight and loop

Model

All 18in Steel Models

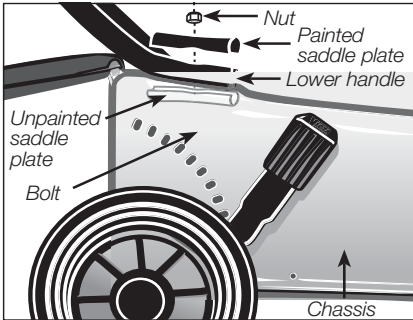

****Disconnect spark plug lead first****

1. Place one of the bolts through one of the unpainted saddle plates
2. Whilst holding open the rear catcher flap, insert the bolt and saddle plate through the rear of the mower and up through the small hole in the left hand side of the lawnmower chassis, from underside.
3. From the topside, place lower handle (straight or loop), then one of the black painted saddle plates onto the protruding bolt.
4. Thread one of the nuts onto the top of the bolt, and tighten with fingers
5. Push and hold the bolt up so that the square shoulder of the bolt is located in the unpainted saddle plate then tighten the nut to 22Nm. the bolt is located in the unpainted saddle plate then tighten the nut to 22Nm.
6. Repeat on other side.

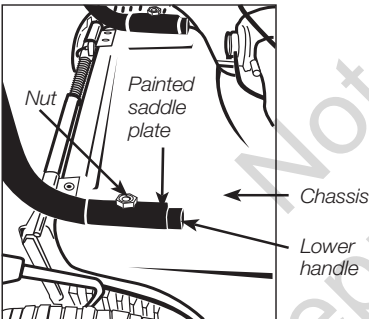

Attaching upper handle

Comfort Grip & Straight Handles

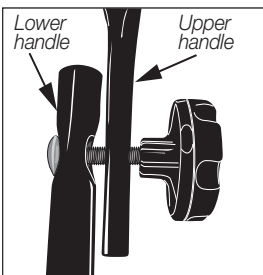

- Attach the upper handle to the lower handles using the knobs and bolts provided. The knobs should be on the outside.

Attaching the throttle control

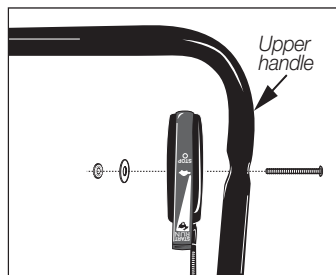

- Attach the throttle control to the inside of the upper handle, so that the lever lifts upward toward the user.

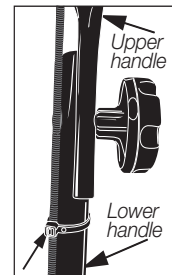

- Secure the throttle cable to the lower handle with the cable tie.

ASSEMBLY PROCEDURES



Mulching Plug - (mulch or catch models only)

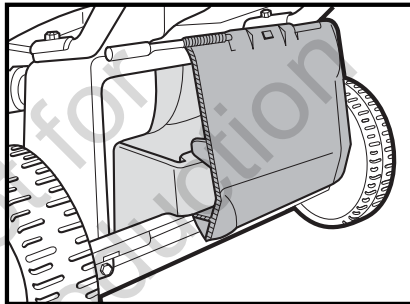
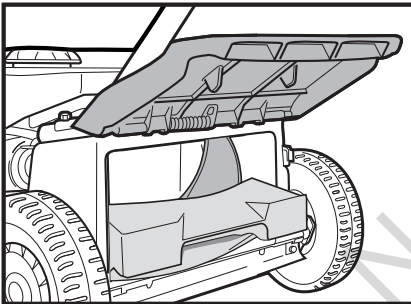
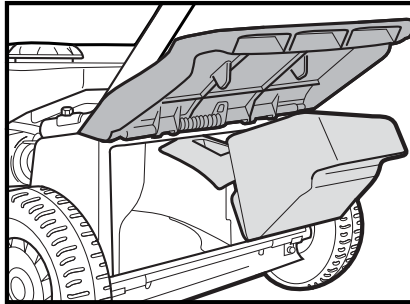
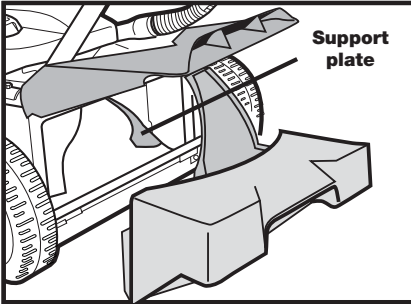

- Stop the engine and set the mower height setting.
- Mulching is most effective between height settings 4 and 10.
- Lift the rear flap and identify the support plate as shown. Note the orientation of the mulching plug.
- Insert the mulching plug into the baseplate.
- Ensure that the mulching plug is resting on the support plate and is positioned against the inside of the baseplate. Push the mulching plug down so that it rests flush against the rear cross member.
- Close the rear flap ensuring that it closes fully. The rear flap should rest on the mulching plug as shown in the sectional illustration.



STOP the engine before inserting or removing the mulching insert.



ASSEMBLY PROCEDURES

Aerogrip Handle Assembly

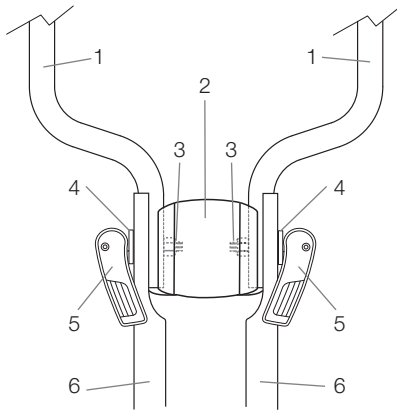

Your Aerogrip handle may require some assembly before its first use. If the upper and lower handle have been supplied unattached, follow these instructions below.

PIVOT JOINT COMPONENTS

ITEM	QTY
1. Lower handles	x 2
2. Centre knuckle	x 1
3. Lock nut	x 2
4. Washer	x 2
5. Lever	x 2
6. Upper handles	x 1

Assembly Procedure

- 1 Lay the upper handle across the engine cowl of the lawnmower, with the bend facing down (see Fig. 1).
- 2 Position the ends of the upper handle over the lower handles at the pivot joint, so that the holes are all aligned.
- 3 Push the locking bolt through the holes of both handles (making sure the washer is on the lever side). (see Fig. 2).
- 4 Place lock nut on the inside of the handles. Tighten the nut while checking the operation of the lever (over tightening will make the lever hard to operate and deform, under tightening will result in loose handles).
- 5 Position the centre knuckle in between the lower handles and firmly push the knuckle into the ends of the lower tubes.
- 6 For 2 stroke models with the centre snorkel, the recess faces upwards. Other models have the knuckle recess facing downward. (see Fig. 3).

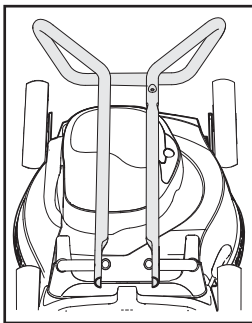

Fig. 1

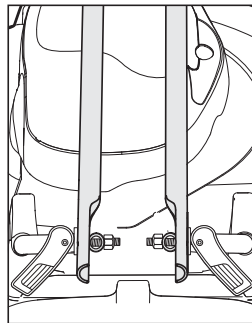

Fig. 2

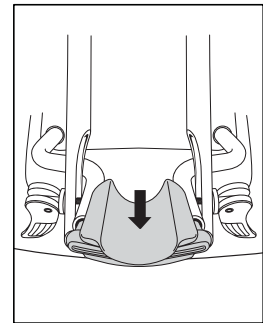

Fig. 3

ASSEMBLY PROCEDURES



Attaching The Remote Air Filter Housing

Aerogrip Handles

2 Stroke Models

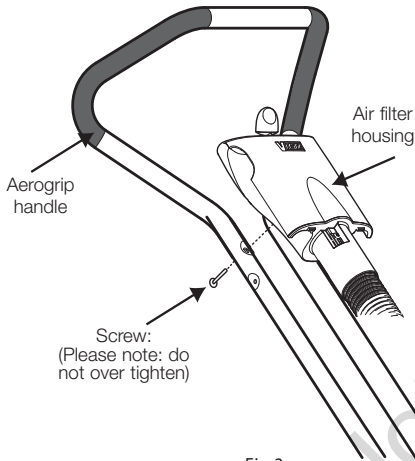

Fig. 3

4 Stroke Models

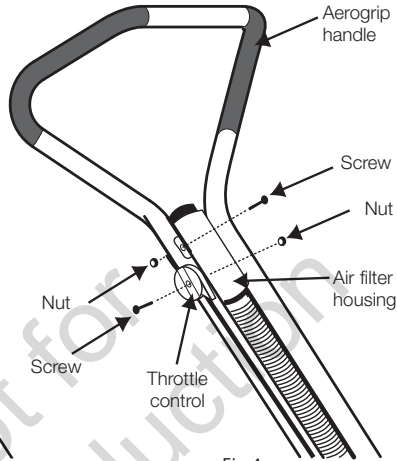
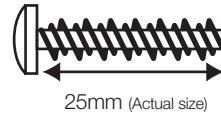

Fig. 4

4 Stroke Models

Slide the air filter housing onto the upper handle. Position locating lug into hole in handle and secure with screw (see Fig.3). Be careful not to over tighten, as the plastic thread may be damaged.



4 Stroke Models

- 1 Firstly secure the throttle control to the right hand side of handle, on the outside (see Fig. 4) using the 50mm screw and nut pictured here.
- 2 **For models supplied with remote air filter.** After attaching the throttle control, secure the air filter housing to the right hand side of handle, on the inside (also Fig. 4), using the 38mm screw and nut pictured here.

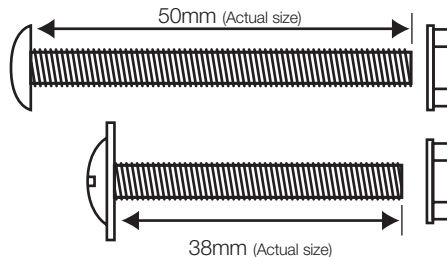



ASSEMBLY PROCEDURES

Attaching The Remote Air Filter Housing - throttle control

Comfort Grip Handles

2 Stroke Models

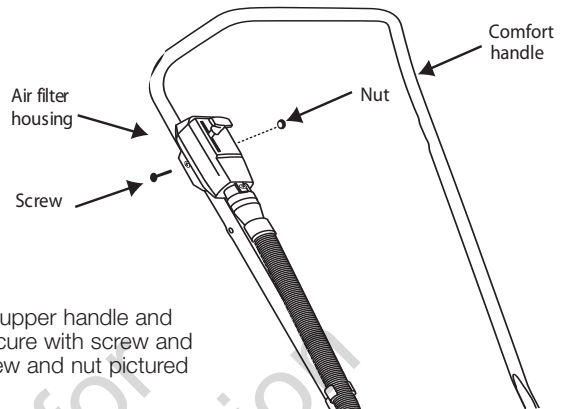
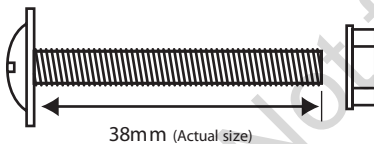

Fig. 1

2 Stroke Models

Slide the air filter housing onto the upper handle and align to locating hole in handle. Secure with screw and nut (see Fig.1). Use the 38mm screw and nut pictured here.



Attaching The Battery

(Applicable to Keystart models only)

- Clip battery pack to handles, ensuring that the locating pin in the top clip is inserted into the hole in the top of the upper handle tube.
- Plug harness into connector (this may already have been connected at manufacture, if not please connect).

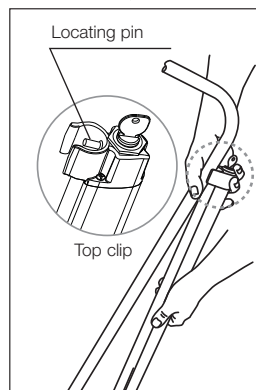

Top of upper handle

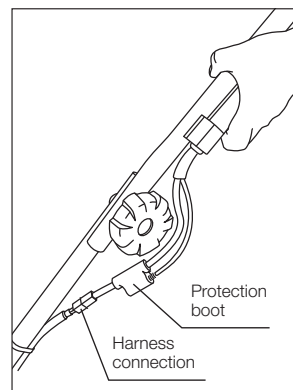

Bottom of upper handle

ASSEMBLY PROCEDURES



Mulching / Catching

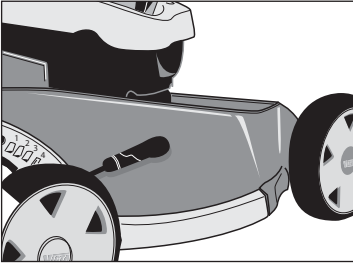

Height adjustment allows lawn to be cut at different lengths.

- Set cutting height by adjusting the height lever.
- For Mulch or Catch models, mulch grass between settings 4 to 10.
- A lower setting may be used depending upon conditions.



STOP the engine before adjusting the cutting height.

Mowing & Mulching Tips

- A mulching mower is designed to cut, retain, and recut the clippings until they have reached a very small size. These are then blown down into the root system as nutrients for your lawn.
- For best mulching results only mow the top 1" / 2.5cm of lawn growth. If grass has become excessively long choose a height setting and gradually reduce the cutting height after each pass, or use grasscatcher.
- Mulch grass between heights settings 4 and 10. A lower setting may be used depending on conditions.
- Dry grass will aid in the mulching action of the mower.
- Cut the grass regularly to avoid it becoming too long and making it difficult to mulch.
- As a general rule, only cut the top one third of the grass length (approximately). More than this may leave an untidy appearance and finish.
- Mulching is sensitive to the chosen height setting. If the height setting is too low cut grass may be left on top of the lawn. In this case raise the height setting.
- Cut the grass in the late afternoon or morning. This will stop the grass being damaged by direct sunlight.
- To maintain cutting performance keep the underside of the mower clean.
- The cutting pattern should be varied from week to week (eg. North-South to East-West).
- When using a mulcher the grass tends to be carried along with the mower. Mow from the thick grass to light grass as this will deposit clippings and encourage growth in these areas.
- Excessively long grass will not be mulched adequately, in this case, it is recommended to use grasscatcher.
- Worn or incorrect blades will reduce lawn finish and will not mulch properly.
Use only genuine Victa blades and replace them regularly.



OPERATING INSTRUCTIONS

Starting & Stopping

2 Stroke Engine - See engine manual or Key start procedure below.

4 Stroke Engine - Honda GCV 160, see engine manual and procedure below.

4 Stroke Engine - Briggs & Stratton, see engine manual and procedure below.

STEP-1. Move the throttle control lever to the choke/start position.

Starting hot: Use the RUN position if the Engine is warm.

Note: If engine does not have a choke. Move the throttle lever to the START position and primer three times slowly.

COLD START: press the primer bulb three times pausing each time.

HOT START: priming may only be necessary if the mower fails to start.

Briggs & Stratton

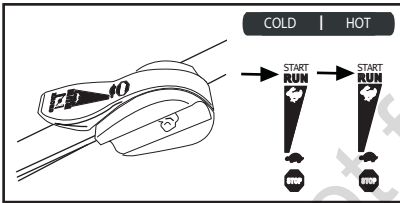

Honda

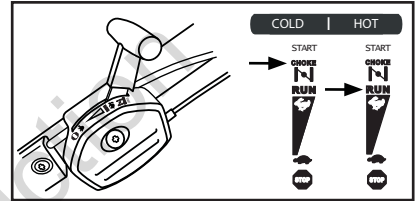

STEP-2a. **(Pull Start)** Pull the starter grip lightly until resistance is felt, then pull briskly.



CAUTION!

Do not allow the starter grip to snap back against the engine. Return it gently to prevent damage to the starter.

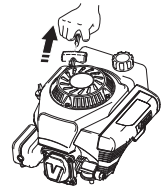

2b. **(Key Start)** Turn the starter key until fully engaged. When engine starts return the key to its original position.



CAUTION!

Do not crank the engine over for more than 15 seconds at a time!

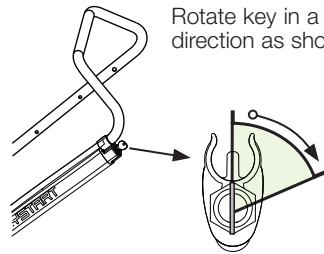

Rotate key in a clock wise direction as shown.

2c. **(2 Stroke)** When the engine warms up, move the throttle to the RUN position.

STOPPING THE ENGINE

Move the throttle control lever to the STOP position.

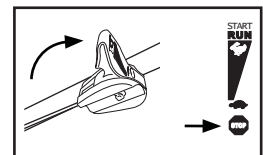

OPERATING INSTRUCTIONS



Self Propelled

Drive Control operation

- To engage drive - press engagement lever against mower handle.
- Hold there while drive is required.
- To disengage drive - release lever.

NOTE: Drive control adjustment is automatic
All self propelled models are fitted with a self adjusting mechanism which eliminates the need for any drive control adjustment.

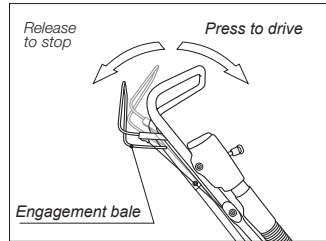

Cleaning



Before cleaning the mower, ensure the throttle lever is in the 'STOP' position. Turn the fuel tap off, disconnect the spark plug lead and wedge it between the cylinder fins, and disconnect the battery on Keystart models.

- Remove grass build up from the air intakes on the top of the mower cowl, around the engine and carburettor, and around the air filter body.
- The underside of the mower should be cleaned regularly to remove dirt and grass build up, as any build up will adversely affect grass catching and mulching performance and can promote corrosion on steel baseplates.

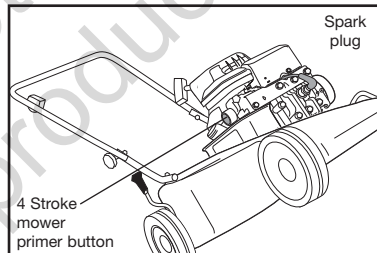
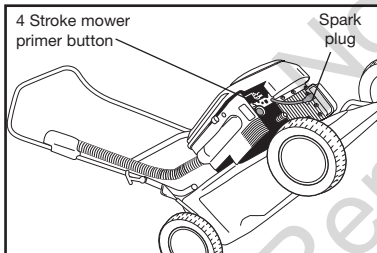

- **When cleaning the underside of the mower, always tilt handle back to ground level so the front wheels are off the ground and spark plug is pointing to the sky. Tilting in other directions can cause the oil to contaminate the fuel & damage airfilter causing starting difficulties.**
- A hose may be used on the underside of your mower ONLY. Care must be taken to NOT get water into the engine, as it may damage the magneto or get into the fuel system.
- If your mower is fitted with a washport, simply attach a garden hose whilst the engine is running and turn on the water.
- On Keystart models keep the battery, starter switch, starter motor and all leads dry.
- To prevent chassis corrosion, the underside of your mower should be cleaned immediately after mowing an area which has been recently dressed with sulphate of ammonia or fertiliser.
- After cleaning, run the engine briefly to dry off excess moisture before storing.

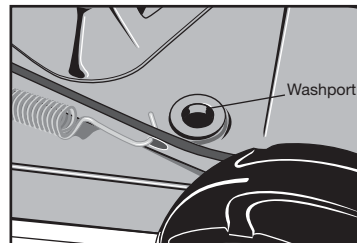

(Only on some alloy baseplate models)



MAINTENANCE & CARE

Blade Replacement

Model

All 19in Steel and Alloy Chassis Models

All 18in Steel Chassis Models

For Your Safety

- Never use the mower unless the grasscatcher or the guards supplied by the manufacturer are in position.
- Before starting the mower check blades and bolts for damage or wear.
- If you strike an obstruction, stop the engine and check the blades for damage.



Worn and damaged blades are major hazards.

- Stop the engine and disconnect the spark plug lead before fitting new blades.
- Work from the grasscatcher flap.

With the rear flap secured, undo the blade nut, applying upward pressure to the bolt head into the blade disc. (the head of the bolt will not rotate due to the diamond shape in the underside of the head).

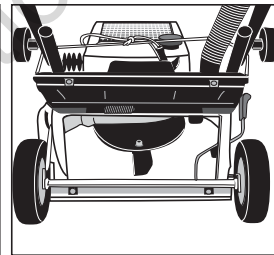
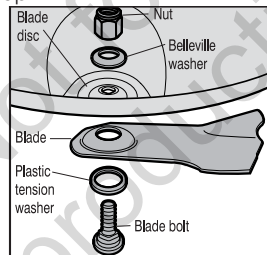

Assembly: Fit as per the drawing remembering to push the head of the bolt into the blade disc (this will stop the bolt head from turning). Ensure correct order of assembly.

DO NOT lay mower on side (4 Stroke models).

- We recommend changing blades, bolts, nuts and washers as a set. Metal fatigue and damage may occur which may not be visible to the operator. Always replace all blades to ensure correct engine balance, reducing vibration and wear. Tighten nuts on blade bolts to 14-19 Nm or 10-14ft lbs.
- **Always turn the nut to check tightness, not the bolt.**



Use only genuine replacement parts made and guaranteed by Victa. Insist on them from your parts and service dealer. Detailed fitting instructions are printed on genuine Victa blade packs. Use of non-genuine blades may void your warranty, and could result in damage or injury.



Blade Replacement

Model

All 16in Steel Models

For Your Safety

- Never use the mower unless the grasscatcher or the guards supplied by the manufacturer are in position.
- Before starting the mower check blades and bolts for damage or wear.
- If you strike an obstruction, stop the engine and check the blades for damage.



Worn and damaged blades are major hazards.

DO NOT lay mower on side (4 Stroke models).

- CAUTION: Be sure to disconnect and ground the spark plug wire before working on the cutting blade to prevent accidental engine starting. Protect hands by using heavy duty gloves or a rag to grasp the cutting blade.

We recommend that the blade bar, washer and bolt be replaced when changing the blade bar tighten to 45-55Nm 32-40ft lbs.



WARNING: Periodically inspect the blade adaptor for cracks, especially if you strike a foreign object. Replace when necessary.



Use only genuine replacement parts made and guaranteed by Victa. Insist on them from your parts and service dealer. Detailed fitting instructions are printed on genuine Victa blade packs. Use of non-genuine blades may void your warranty, and could result in damage or injury.

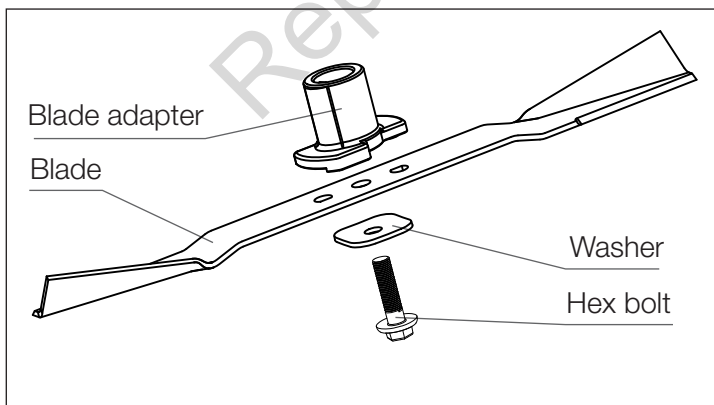

- Before reassembling the blade and the blade adapter to the unit, lubricate the engine crankshaft and the inner surface of the blade adapter with light oil. Install the blade adapter on the crankshaft. Refer to the figure above. Place the blade with the part number facing away from the adapter. Align the washer over the blade and insert the hex bolt. Tighten the hex bolt to 45-55Nm 32-40ft lbs.



MAINTENANCE & CARE

Remote Air Filter Maintenance

For correct engine performance and to guard against dust entering the engine, causing rapid wear, the air filter assembly must be clean and maintained in good condition. VICTA recommends that the air filter element and seal ring are replaced annually, or more often in dusty conditions. Always replace with genuine Victa spare parts. Use of non-genuine spare parts may damage your mower engine, and void the product warranty.

Replacing Air Filters

STOP ENGINE.

(Fig. 1) 4 Stroke models, twist filter cap anti-clockwise and remove cap from filter housing.

(Fig. 2) 2 Stroke models, lever cap off using screw driver in slot in side of filter body.

To stop loose material falling into filter body, tilt upper handle so that filter body is upside down. Remove filter element and seal ring.

(Fig. 3) Clean filter element "A" by tapping it on palm of hand. Do not use compressed air or wash with any liquid. Examine element for holes, splits or permanent clogging. Replace if necessary.

Dust off seal ring "B" and examine. Replace if damaged or permanently crushed.

(Fig. 4) Fit or refit seal ring and filter element. Tilt upper handle back to normal position.

Push filter cap on, ensuring teeth engage in slots on filter housing.

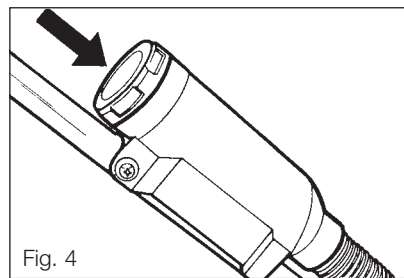
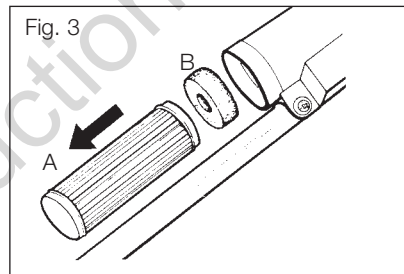
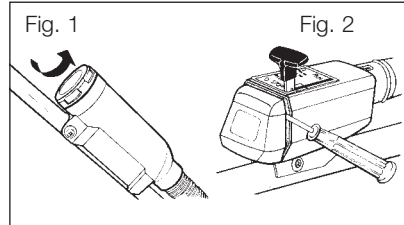

**Victa air filter for all 2 Stroke and 4 Stroke domestic models
Part No AF072825**



Remote Air Filter Maintenance – Aerogrip Handles

- 1 Examine the air filter hosing for holes, chafing and leaks. Replace it if damaged.

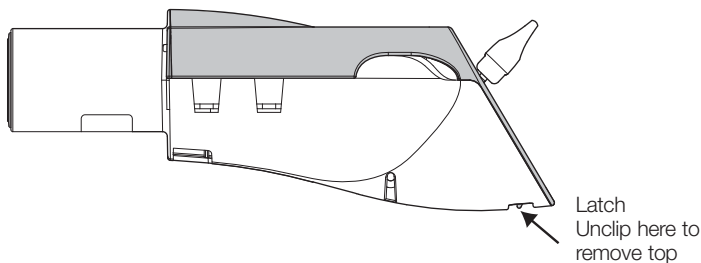

- 2 Remove the top cover of the air filter housing by squeezing the latch on the underside of the housing and lifting upwards.

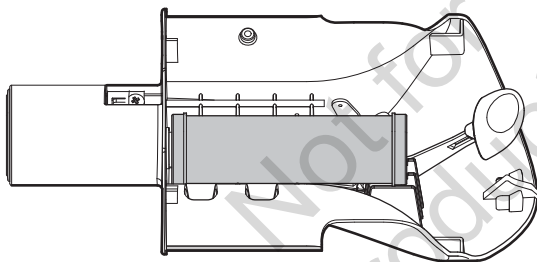

- 3 Remove the element and the foam seal ring, taking care that any loose dirt does not fall into the filter body.
- 4 Dust off the seal and examine it. Replace it if damaged or permanently crushed. Refit seal to housing.

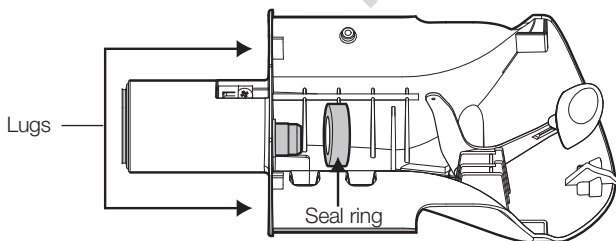

- 5 Clean the element by slapping it on the palm of your hand. Do not use compressed air or wash the element in any liquid. Examine the element for holes, splits or permanent clogging. Replace the element if necessary. Refit element to housing.
- 6 Refit the top cover by making sure the lugs at the rear of the cover are located before clipping in the latch.



MAINTENANCE & CARE

Keystart Battery



Do not disassemble, puncture or incinerate the battery.



Do not allow the battery terminals to contact metal or conductive surfaces. This will cause a spark sufficient to ignite fuel vapors which may result in fire and injury.



Do not make direct contact between the positive and negative terminals as this will cause a high current flow, creating sparking and/or a possible fire hazard.



Reversing the connections will damage the charger, necessitating replacement.



Ensure the recharge socket is securely held inside the protection boot. Only remove the recharge socket from the boot when charging.



Take care when adjusting the handles to ensure the battery harness is not pinched or severed inside the clamps for the upper handle.

- The battery is a Nickel Metal Hydride (NiMH) battery and is rechargeable. The lawnmower is provided with a specific charger for the battery and also has a conventional recoil starter with a pull type starter cord. Only use the charger supplied for recharging as alternative chargers may damage the battery and void the warranty.
- Begin the mowing season with the battery fully charged. During periods of non-use, the battery charge will reduce. It is recommended that the battery be charged every six months when not in use.
- The battery can be continuously charged while in storage, for up to 6 weeks with the supplied charger. Should this be exceeded the condition will deteriorate.
- To avoid deep-discharge damage or inconvenient charging preparation, fully recharge the battery for a minimum of 10 hours when the mower first shows signs that the power level is insufficient to start the mower. DO NOT persist starting an engine in poor condition, or with a low charge battery pack.



Keystart Battery

Handling and Care

Like all batteries, these units contain corrosive fluids and toxic materials. Handle the battery with care.

- Keep children away from the battery.
- The battery should be charged by adults.
- Charge the battery in a well ventilated area.
- Keep the battery clean. Do not clean with petrochemicals. Dust with a soft brush and ensure that dust does not collect on the battery terminals, recharge socket or inside the protection boot.
- Store the battery in a cool dry place.
- Do not allow the battery to become wet or immersed in water.
- Do not dispose of the battery pack in with domestic waste. Contact your local waste management authority for instruction of safe disposal.

First Aid Following these instructions carefully if the battery breaks or cracks and some of its contents are contacted or ingested contact the poisons information centre or call a doctor immediately.

Recharging the battery

2 Stroke and 4 Stroke

- Remove the recharging socket from the protection boot Fig. 1
- Connect the charger plug into the recharging socket.
- Plug the charger into a 240V 50 Hz outlet. Charge the battery for a minimum of 10 hours to 48 hours. After 48 hours the battery should be fully charged.

4 Stroke (Only)

NOTE: The battery pack can be removed and recharged away from the mower. Un-clip connector located at lower handles then remove battery pack from upper handle. Follow the recharging instructions above.

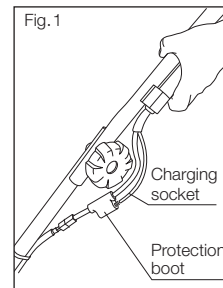

Disconnect cable as shown.

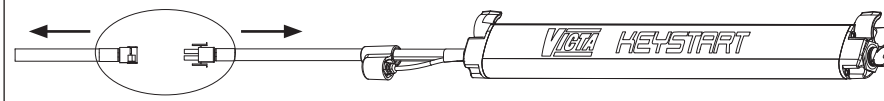

Keystart Battery

Store the mower in a well ventilated area, away from any naked flames found in gas hot water heaters.

- Turn the fuel tap off.
- Disconnect the spark plug lead and wedge it between the cylinders head fins.
- Clean the mower thoroughly before storing.
- Always store the battery with the charging socket inside the protection boot.

Note: After cleaning, run the engine briefly to dry off the excess moisture before storing.



MAINTENANCE & CARE

Maintenance Chart

Refer to the following table for routine maintenance.

Features	Requirements	Time Period							
		Before start	After finish	Refuelling	Weekly	Monthly/	If faulty	If damaged	As required
Lawnmower	Visual inspection (leaks)	•		•					
Throttle lever	Check operation		•						
Remote air filter hose	Check	•				•			
Cutting system (Blades)	Inspect and check assembly	•							
	Replace						•	•	
Rear flap	Inspect and check assembly	•							•
Chassis	Check for buildup of grass		•						
	Clean		•						
	Replace							•	
Air filter	Check	•							
	Clean	•							
	Replace						•	•	
Engine cylinder fins	Clean					•			•
Spark plug	Replace						•		•
All accessible fasteners	Check	•							
	Retighten								•
Engine mounting bolts	Check and retighten					•			
Mulching plug	Inspect and check assembly	•							•
Muffler	Inspect					•		•	
	Replace							•	•
Grasscatcher	Check	•							
	Clean		•						
	Replace							•	



Before carrying out maintenance, STOP the engine, disconnect the spark plug lead from the spark plug and wedge it between the cylinder head fins. Remove the starter key from the ignition switch of Keystart models and disconnect the battery.



Never attempt maintenance that is not outlined in this manual. All repair work must be carried out by a VICTA Authorised Service Centre.



Troubleshooting

Problem	Possible cause	Correction
Does not start	Out of fuel	Refill tank with correct fuel
	Throttle lever in incorrect position	Refer to 'Starting Procedures'
	Spark plug lead not connected	Press terminal cover fully onto the spark plug
	Engine flooded	Turn fuel tap 'OFF'. Pull starter cord until engine starts, then turn fuel tap 'ON'
	Dirty spark plug	Replace spark plug
	Stale fuel in tank from last season	Contact Service Centre
	Water in fuel tank	Contact Service Centre
	Service required	Contact Service Centre
	Engine worn	Contact Service Centre
	Low or no oil (4 stroke)	Top up with correct oil
Loss of power	Incorrect throttle setting	Set throttle lever in the 'RUN' position
	Dirty air filter element	Clean or replace
	Too low height adjustment	Raise cutting height
	Low or no oil (4 stroke)	Top up with correct oil
Poor cutting or catching	Blades worn or damaged	Replace
	Blade disc loose	Contact Service Centre
	Slow running	Refer to 'Loss of Power' above
	Blades restricted by grass and dirt accumulated under the baseplate	Remove spark plug lead and clean under the baseplate
	Blocked vents in grasscatcher	Clean vents
Excessive vibrations	Build up of grass and dirt on upper surface of blade disc	Clean
	Blades out of balance	Replace both blades
	Bent or damaged disc or blade	Replace disc or both blades
	Looseness of assembly	Check all nuts for tightness
	Low or no oil (4 stroke)	Top up with correct oil
Engine stops frequently	Fuel supply blocked	Check fuel line
	Engine worn or seized	Contact Service Centre
	Fuel cap not venting	Check / Loosen cap slightly
	Low or no oil (4 stroke)	Top up with correct oil

If running difficulties continue, please contact your closest Victa Authorised Service Centre. You will find the latest Service Centre listing on the Victa website, www.victa.com.au or contact Victa Customer Service 1800 356 632.



WARRANTY

Warranty

Consumer Rights

The buyer should be aware that in relation to goods which are of a kind ordinarily acquired for personal, domestic or household use or consumption, certain provisions such as the Trade Practices Act, 1974 (Aust) and the Consumer Guarantees Act, 1993 (NZ) apply. The terms set out below do not exclude rights and remedies implied by a statute which are non-excludable and which may be more extensive than those provided by this warranty.

Warranty Service

Warranty Service under both the Express Warranty and the warranties implied by law is available at any VICTA Authorised Service Centre. These centres are staffed and equipped to provide expert service.

VICTA Express Warranty

The VICTA Express Warranty is additional to the conditions and warranties which are mandatorily implied by the laws and regulations of the individual States and Territories of Australia and the Trade Practices Act, 1974 (Aust) and the Consumer Guarantees Act in New Zealand and any non-excludable laws.

Petrol Mowers Models		Domestic Models Only	
		Baseplate	Engine
16in Models			
All 16 in models		1yr	2yr
18in Models			
All other 18in Models		2yr	2yr
GCS464	Corvette 450	3yr	3yr
GMS464	Corvette 500	3yr	3yr
19in Models Steel Base			
All 19in Tornado Models		2yr	2yr
PMS485 (Honda)	Panther	2yr	2yr
PCS485 (Honda)	Panther	2yr	2yr
19in Models Steel Base (Gold Warranty)			
GCS482 (2 st)	Corvette 600	4yr	3yr
GCS484	Corvette 600	4yr	3yr
GMS482 (2 st)	Corvette 600	4yr	3yr
GMS484	Corvette 600	4yr	3yr
GMS486	Corvette 650	4yr	4yr
GMS488	Corvette 700	4yr	4yr
19in Models Alloy Base			
All 19in Broncos		2yr	2yr
MCA482	Mustang	2yr	2yr
MCA484	Mustang	2yr	2yr
MCA485	Mustang	2yr	2yr
19in Models Alloy Base (Gold Warranty)			
MCA486	Mustang	4yr	4yr
MCA488	Mustang	4yr	4yr
Professional Use	Any Mower	3 mths / 90 days	3 mths / 90 days



Warranty continued

Under Express Warranty the Lawnmower is warranted from the date of purchase against mechanical defects and faulty workmanship or material. Express Warranty covers only the replacement, repair or adjustment of parts which fail due to a fault in manufacture.

Defective parts will be replaced or serviced by an Authorised Service Centre without charge for labour or materials, subject to conditions. Repairs or adjustments required by normal use or by failure to follow the manufacturer's instructions are chargeable to the owner.

Authorised Service Centre are authorised to determine whether a claim will be covered under warranty, or payable by the owner on completion.

You should seek independent legal advice to determine whether a claim not covered by the Express Warranty is covered by any warranties implied by law.

- Express Warranty applies to the original purchaser only. Proof of purchase date must be provided prior to Express Warranty work.
- Use of parts other than genuine Spare Parts cancels the Express Warranty.
- Repairs other than by an Authorised Service Centre cancels the Express Warranty.
- Altering the product (including governed speed) cancels the Express Warranty..
- **A lawnmower run with incorrect fuel, oil or oil level, is not covered by the Express Warranty.**
- Failure to properly service cooling or air filtration systems cancels the Express Warranty.
- Failure to follow the instruction manual or labels attached cancels the Express Warranty.
- Fair and reasonable wear is not covered by the Express Warranty.
- Damage from an accident, misuse or neglect is not covered by the Express Warranty.
- Costs of transportation of the lawnmower are to be paid by the owner.
- **Blades and spark plugs are not covered by the Express Warranty.**

Limitations of Warranty

Nothing in these terms shall exclude, restrict or modify any term, condition, warranty or liability implied into this contract by statute, where to do so would be unlawful or would render any provision of this contract void. Subject to that, all warranties implied by statute in respect of the goods are hereby expressly negated and the manufacturer's liability for the goods is limited to any warranties issued in writing by manufacturer and manufacturer is excluded from any liability whether under this contract or otherwise to the buyer of any third party for any loss, injury, cost or damage (direct, indirect, special, consequential, or otherwise and whether or not arising from a negligent act or omission of the manufacturer), incurred or suffered by reason for the goods, their use, their design or any failure to deliver or delay in delivering them. Where it is legal to do so, any remaining liability implied by statute or resulting from breach of any term, condition or warranty implied by statute is limited to, at the manufacturer's sole option:

- the replacement of the goods or the supply of equivalent goods;
- the repair of goods;
- the payment of the cost of replacing the goods or of acquiring equivalent goods; or
- the payment of having the cost of the goods repaired.

In particular, your rights and remedies under the Trade Practices Act (Aust) and the Consumer Guarantees Act (NZ) are not excluded.



WARRANTY

Warranty continued

Australian warranty laws have recently changed.

Our goods come with guarantees that cannot be excluded under the Australian Consumer Law. You are entitled to a replacement or refund for a major failure and for compensation for any other reasonably foreseeable loss or damage. You are also entitled to have the goods repaired or replaced if the goods fail to be of acceptable quality and the failure does not amount to a major failure.

This guarantee supplements our warranty document located inside this carton. If you have any question regarding these changes please contact Briggs & Stratton Australia on 1300 274 447 or visit www.briggsandstrattonwarranty.com.au or www.victa.com/au/support-centre/warranty-information/

This warranty operates in addition to your rights at law.

NOTES



Not for
Reproduction

NOTES



Not for
Reproduction

Not for
Reproduction

©2012 Victa Lawncare Pty Ltd

Victa is a trademark of Victa Ltd.

Victa Razor & Aerogrip are registered trademarks of Victa Ltd.

All rights reserved. No part of this booklet may be reproduced by any means without prior written permission. All information herein is subject to change without notice.

D	EK	GL	Revised	26/3/12
C	AT	DT	Revised	26/1/11
B2	AT	DT	Revised	09/11/10
B1	AT	DT	Revised	28/4/10
A9	AT	DT	Revised	17/02/10

LR00803A-D