

STIHL[®]

STIHL BGE 61, 71, 81, SHE 71, 81

Instruction Manual



Contents

Guide to Using this Manual	2
Safety Precautions and Working Techniques	2
Assembling the Blower	8
Assembling the Vacuum Shredder	8
Connecting to Power Supply	10
Switching On	11
Switching Off	12
Storing the Machine	12
Maintenance and Care	13
Minimize Wear and Avoid Damage	14
Main Parts	15
Specifications	16
Maintenance and Repairs	17
Disposal	18
EC Declaration of Conformity	18

STIHL®

This instruction manual is protected by copyright. All rights reserved, especially the rights to reproduce, translate and process with electronic systems.

Dear Customer,

Thank you for choosing a quality engineered STIHL product.

It has been built using modern production techniques and comprehensive quality assurance. Every effort has been made to ensure your satisfaction and trouble-free use of the product.

Please contact your dealer or our sales company if you have any queries concerning this product.

Your



Dr. Nikolas Stihl

Guide to Using this Manual

Pictograms

All the pictograms attached to the machine are shown and explained in this manual.

Symbols in text



WARNING

Warning where there is a risk of an accident or personal injury or serious damage to property.



NOTICE

Caution where there is a risk of damaging the machine or its individual components.

Engineering improvements

STIHL's philosophy is to continually improve all of its products. For this reason we may modify the design, engineering and appearance of our products periodically.

Therefore, some changes, modifications and improvements may not be covered in this manual.

Safety Precautions and Working Techniques



Special safety precautions must be observed when working with this power tool. The power supply is a particular source of danger.



It is important that you read the instruction manual before first use and keep it in a safe place for future reference. Non-observance of the instruction manual may result in serious or even fatal injury.



WARNING

- Minors should never be allowed to operate this machine. Watch children to be sure that they do not play with the power tool.
- This power tool may be operated only by persons who have been instructed in its use and proper handling.
- Persons who are not able to operate the power tool safely due to limited physical, sensory or mental ability may work with it only under supervision or after being instructed appropriately by a responsible person.

- Lend or rent your power tool only together with this instruction manual and only to persons who are familiar with this model and its operation.
- **Disconnect plug from wall outlet** before performing any work on the machine, e.g. cleaning, maintenance, replacing parts.

Observe all applicable local safety regulations, standards and ordinances.

When the power tool is not in use, put it in a place where it does not endanger others. Secure it against unauthorized use, disconnect the plug from the power supply.

The user is responsible for avoiding injury to third parties or damage to their property.

If you have not used this model before: Have your dealer or a trained expert show you how to operate it properly and safely.

The use of noise emitting power tools may be restricted to certain times by national or local regulations.

Before each use, check that your power tool is in good condition. Pay special attention to the power cord, mains plug and safety devices.

Do not operate your power tool if any of its components are damaged.

Do not use the power cord to pull or carry the power tool.

Do not use a pressure washer to clean your power tool. The solid jet of water may damage parts of the power tool.

Never spray water on the unit – **risk of short circuit!**

Physical Condition

To operate this power tool you must be rested, in good physical condition and mental health.

If you have any condition that might be aggravated by strenuous work, check with your doctor before operating a power tool.

Do not operate the machine if you are under the influence of any substance (alcohol, drugs) which might impair vision, dexterity or judgment.

Intended Use

The blower is designed for blow-sweeping leaves, grass, paper and similar materials, e.g. in gardens, sports stadiums, car parks and driveways.

The vacuum shredder is designed for picking up dry leaves and other lightweight, loose and non-combustible debris.

Do not blow-sweep or vacuum hazardous materials.

Do not operate your power tool indoors.

Do not use your power tool for any other purpose because of the increased risk of accidents and damage to the power tool itself. Never attempt to modify the product in any way since this may result in accidents or damage to the product.

Operating Conditions



Never work with the power tool in the rain, snow or in wet or very damp locations. Do not leave the power tool outdoors in the rain.

Clothing and Equipment

Wear proper protective clothing and equipment.



Clothing must be sturdy but allow complete freedom of movement. Wear snug-fitting clothing, an overall and jacket combination, do not wear a work coat.



Avoid any clothing, scarves, neckties, jewelry or anything that could get into the air intake. Tie up and confine long hair (e.g. with a hair net, cap, hard hat, etc.).

Wear sturdy shoes with non-slip soles.



To reduce the risk of eye injuries, wear close-fitting safety glasses in accordance with European Standard EN 166. Make sure the safety glasses are a comfortable and snug fit.

Wear hearing protection, e.g. earplugs or ear muffs.

STIHL offers a comprehensive range of personal protective clothing and equipment.

Accessories

Only use parts and accessories that are explicitly approved for this power tool by STIHL or are technically identical. If you have any questions in this respect, consult a servicing dealer. Use only high quality parts and accessories in order to avoid the risk of accidents and damage to the machine.

STIHL recommends the use of original STIHL replacement parts and accessories. They are specifically designed to match the product and meet your performance requirements.

Never attempt to modify your machine in any way since this may increase the risk of personal injury. STIHL excludes all liability for personal injury and damage to property caused while using unauthorized attachments.

Before Starting Work

Inspect the power tool.

- Trigger switch/switch lever must move easily to **STOP** or **0**
- The trigger/switch lever must be on **STOP** or **0**.
- The blower tubes must be properly assembled.

- Handles must be clean and dry, free from oil and dirt, for safe control.
- Check condition of blower wheel and blower housing – see chapter on "Using the Vacuum Attachment".

To reduce the risk of accidents, do not operate your power tool if it is not properly assembled and in good condition.

Do not operate your power tool if any of its components are damaged or not properly mounted.



Risk of injury from contact with rotating blower wheel. Always switch off the motor and disconnect the plug from the power supply before removing the intake screen, suction tube, blower tube or elbow. Wait for the blower wheel to come to a complete standstill.

A worn blower housing (cracks, nicks, chips) may result in an increased risk of injury from thrown foreign objects. If the blower housing is damaged, consult your dealer – STIHL recommends you contact a STIHL servicing dealer.

Never attempt to modify the controls or the safety devices in any way.

Electrical Connection

Reduce the risk of electric shock:

- Voltage and frequency of the power tool (see rating plate) and the voltage and frequency of your power supply must be the same.
- Check the connecting cord, plug and extension cord for damage. Never use damaged cords, couplings and plugs or connecting cords that do not comply with regulations.
- Always connect the power tool to a properly installed wall outlet.
- Check that the insulation of the power cord, extension cord, plug and coupling is in good condition.
- Never touch the mains plug, connecting cord, extension cord or electrical connections with wet hands.

Position the connecting and extension cords correctly:

- Check minimum cross section of wires (wire gauge) – see "Connecting to Power Supply".
- **To reduce the risk of stumbling**, position and mark the connecting cord so that it cannot be damaged or endanger others.
- Using unsuitable extension cords can be dangerous. Use only extension cords approved for outdoor use which are labeled as such and have the appropriate wire gauge.

- The plug and coupling of the extension cord must be water-proof and must never be immersed in water.
- Do not chafe on edges, pointed or sharp objects
- Do not squeeze through gaps in doors or windows
- If cords are twisted – unplug the power tool and straighten them out
- Always unwind the extension cord completely from the cable drum to reduce the risk of fire from overheating.

Holding and Controlling the Power Tool

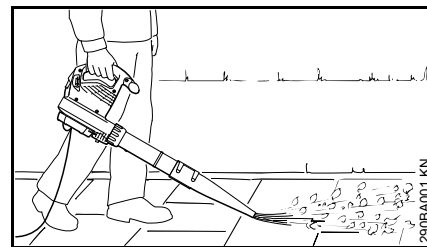

Your blower is designed for one-handed operation. It can be carried by the control handle in either the right or left hand.

Always hold the power tool firmly in your hand.



To reduce the risk of injury, operate the unit only with a properly mounted blower tube.

The round nozzle is particularly suitable for use on uneven surfaces (e.g. fields and lawns).

The fan nozzle (either included with power tool or available as special accessory) produces a broad and powerful airstream at ground level. It can be aimed and controlled very accurately. This nozzle is highly effective for blow-sweeping sawdust, leaves, grass cuttings, etc. on flat surfaces.

Using the Vacuum Attachment

For specific assembling instructions, see appropriate chapter in this manual.



Your vacuum shredder is designed for two-handed operation. Hold and operate the power tool with your right hand on the control handle and your left hand on the assist handle (union nut).

Wear the catcher bag shoulder strap over your right shoulder, not across your chest. This enables you to quickly remove the power tool and catcher bag in an emergency.

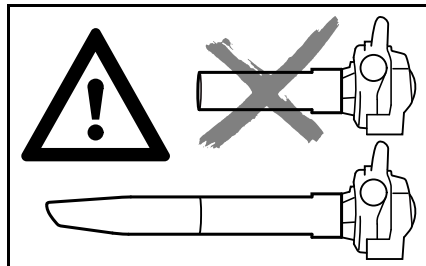

To reduce the risk of injury, operate your power tool only with a properly mounted suction tube and closed catcher bag.



To reduce the risk of personal injury from fire, never attempt to pick up hot or burning substances (e.g. smoldering ashes, glowing cigarettes).



To reduce the risk of fatal injury from fire or explosion, never attempt to pick up combustible fluids (e.g. gasoline) or materials soaked in combustible fluids.



NOTICE

Vacuuming abrasive material (such as grit, stone chips, etc.) causes the blower wheel and blower housing to wear at a rapid rate. This results in a considerable loss of suction power. In such a case

you should contact your dealer. STIHL recommends an authorized STIHL servicing dealer.

Take particular care when vacuuming wet leaves since they may block the blower wheel and elbow.

To clear a blockage in the machine:

- Switch off the motor and disconnect the plug from the power supply.
- Remove the elbow and suction tube – see "Assembling the Shredder Vacuum".
- Clean the elbow and blower housing.

During Operation



If the power cord is damaged, immediately disconnect the plug from the power supply to avoid the risk of electrocution.

Avoid damage to the power supply cord. Do not drive over it, pinch or tug it.

Never jerk the connecting cord to disconnect it from the wall outlet. To unplug, grasp the plug, not the cord.

Be sure your hands are dry before touching the plug or power cord.

In case of imminent danger or in an emergency, move the switch lever/trigger switch to **STOP** or **0**.

Your power tool is designed to be operated by one person only. Do not allow other persons in the work area.

Keep bystanders, especially children, and animals away from the work area.

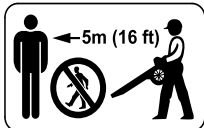

To reduce the risk of injury from thrown objects, do not allow any other persons within a radius of 5 meters of your own position.

To reduce the risk of damage to property, also maintain this distance from other objects (vehicles, windows).

Do not direct the air blast towards bystanders or animals since the air flow can blow small objects at great speed.

When blow-sweeping and vacuum shredding (in open ground and gardens), watch out for small animals to avoid harming them.

Never leave a running machine unattended.

Walk slowly forwards as you work – observe the nozzle outlet at all times – do not walk backwards – **risk of stumbling**.

Keep the connecting cord behind the power tool at all times – do not walk backwards – **risk of stumbling**.

Hold your power tool in a normal, relaxed working position. Make sure you always have good balance and secure footing.

Take care in slippery conditions – on slopes and uneven ground.

Watch out for obstacles: Be careful of refuse, tree stumps, roots and ditches which could **cause you to trip or stumble**.

Never work on a ladder or any other insecure support.

Be particularly alert and cautious when wearing hearing protection because your ability to hear warnings (shouts, alarms, etc.) is restricted.

Work calmly and carefully – in daylight conditions and only when visibility is good. Stay alert so as not to endanger others.

To reduce the risk of accidents, take a break in good time to avoid tiredness or exhaustion.

Static electricity may build-up while blow-sweeping large quantities of very dusty material and suddenly discharge in certain unfavorable conditions (e.g. very dry work area).

If dust levels are very high, always wear a suitable respirator.

Vacuuming unsuitable materials may block the blower wheel. Switch off the unit immediately and disconnect the plug from the power supply. Then clear the blockage.

Never attempt to insert objects into the blower housing through the intake screen or the nozzle. They may be expelled at very high speed by the blower – **risk of injury**.

If there is a noticeable change in running behavior (e.g. higher vibrations), stop work and rectify the cause of the problem.

If your power tool is subjected to unusually high loads for which it was not designed (e.g. heavy impact or a fall), always check that it is in good condition before continuing work – see also "Before Starting Work". Make sure the safety devices are working properly. Do

not continue operating your power tool if it is damaged. In case of doubt, consult your servicing dealer.

If the machine continues to run (does not switch off) after the trigger switch is released, disconnect the plug from the wall outlet and consult your STIHL servicing dealer. The machine has a malfunction.

Before leaving the power tool unattended: Switch it off and disconnect the plug from the power supply.

After Finishing Work

Disconnect the plug from the wall outlet.

Never jerk the connecting cord to disconnect it from the wall outlet. To unplug, grasp the plug, not the cord.

Always clean dust and dirt off the power tool – do not use any grease solvents for this purpose.

Vibrations

Prolonged use of the power tool may result in vibration-induced circulation problems in the hands (whitefinger disease).

No general recommendation can be given for the length of usage because it depends on several factors.

The period of usage is prolonged by:

- Hand protection (wearing warm gloves)
- Work breaks

The period of usage is shortened by:

- Any personal tendency to suffer from poor circulation (symptoms: frequently cold fingers, tingling sensations).
- Low outside temperatures.
- The force with which the handles are held (a tight grip restricts circulation).

Continual and regular users should monitor closely the condition of their hands and fingers. If any of the above symptoms appear (e.g. tingling sensation in fingers), seek medical advice.

Maintenance and repairs

WARNING



Before starting any work on the machine: Always disconnect the machine from the mains power supply.

- Use only high-quality spare parts. Otherwise, there may be a risk of accidents and damage to the unit. If you have any questions in this respect, consult a servicing dealer.
- To avoid risks, work on the machine (e. g. replacing a damaged power cord) may only be carried out by authorized dealers or qualified electricians.

Clean plastic parts with a cloth. Harsh detergents can damage the plastic.

Clean ventilation slots in motor housing as needed.

The machine must be serviced regularly. Do not attempt any maintenance or repair work not described in the Instruction Manual. All other work should be carried out by a servicing dealer.

STIHL recommends the use of genuine STIHL spare parts. Such parts have been optimized for the machine and the user's requirements.

STIHL recommends that maintenance and repair work be carried out only by

authorized STIHL dealers. STIHL dealers receive regular training and are supplied with technical information.

Assembling the Blower

- Disconnect the plug from the power supply.

Mounting the Blower Tube

BGE 71, BGE 81:

Your blower can be switched on only when the blower tube is properly mounted. The union nut activates a switch which closes the circuit to allow the motor to be switched on.

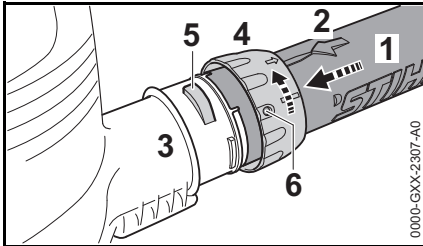

- Line up the recesses. The arrow (2) must be on the top of the blower tube (1).
- Push the blower tube (1) into the blower housing stub (3) as far as the stop.
- Push the union nut (4) over the blower housing stub (3) and turn it in the direction of the arrow until the tab (5) engages the opening (6) in the union nut.

BGE 71, BGE 81:

- You will hear the safety switch being activated.

Mounting the Nozzle

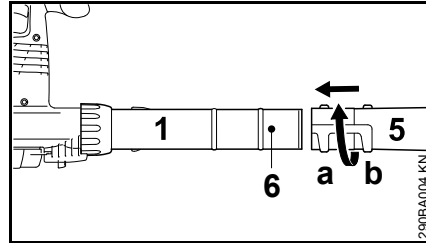

- Push the nozzle (5) onto the blower tube (1) as far as lug (6), position (a) (long) or position (b) (short), and rotate the nozzle in the direction of the arrow to it lock in position.

Removing the Blower Tube

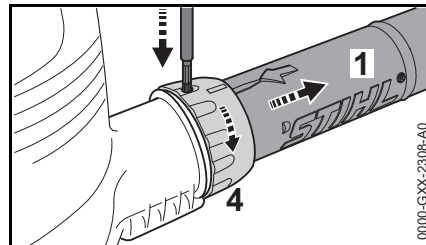

- Switch off the motor.
- Press down the lock button by inserting a suitable tool through the opening in the union nut.
- Rotate the union nut (4) in the direction of arrow as far as the stop.
- Remove the blower tube (1).

Assembling the Vacuum Shredder

Your vacuum shredder can be switched on only when the elbow and suction tube are properly mounted. The union nuts activate a switch which closes the circuit to allow the motor to be switched on.

- Disconnect the plug from the power supply.

Mounting the Elbow



WARNING

Make sure the zipper on the catcher bag is closed.

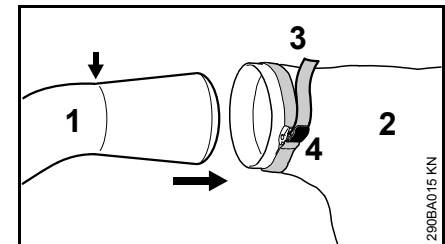

- Push the elbow (1) into the catcher bag (2) as far as the mark (smaller arrow).
- Tighten strap (3) on catcher bag and press down the buckle tab (4).

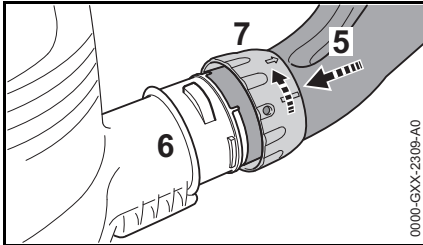

- Line up the recesses.
- Push the elbow (5) into the blower housing stub (6) as far as stop.
- Push the union nut (7) over the blower housing stub (6) and turn it in the direction of the arrow as far as the stop. You will hear the safety switch being activated.

Assembling the Suction Tube

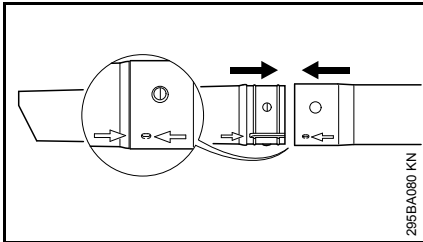

- Line up the arrows on the suction tube and extension tube. Push together and lock in position.

Mounting the Suction Tube

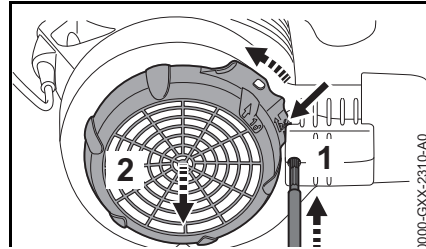

- Switch off the motor.
- Press down the lock button (1) by inserting a suitable tool through the opening.
- Push lug (arrow) against blower housing and hold it there.
- Rotate the intake screen (2) in the direction of arrow as far as the stop and lift it away.

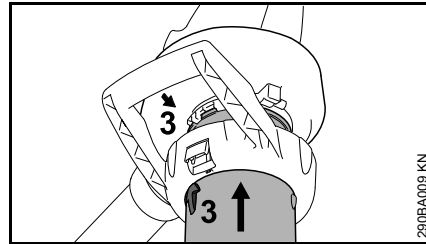

- Line up the arrows (3).
- Push the suction tube into the intake opening as far as the stop.

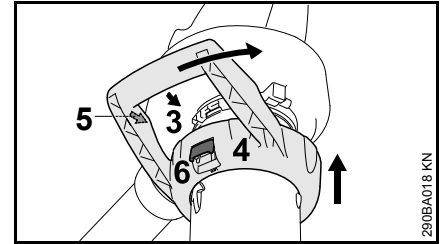

- Push the handle (4) over the intake opening.
- Line up the arrows (3 and 5).
- Rotate the handle (4) in direction of arrow until the lever (6) engages audibly on the blower housing.

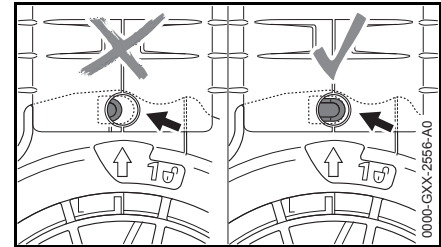

Lock button (arrow) must engage in position.

Removing the Elbow

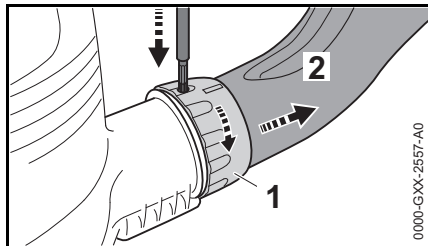

- Shut off the engine.
- Press down the lock button (1) by inserting a suitable tool through the opening.
- Rotate the union nut (1) in the direction of arrow as far as the stop.
- Remove the elbow (2).

Removing the Suction Tube

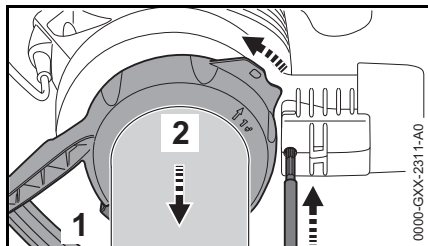

- Shut off the engine.
- Press down the lock button (1) by inserting a suitable tool through the opening.
- Depress lever (1) and rotate handle (2) in direction of arrow as far as the stop.
- Remove the handle together with the suction tube.

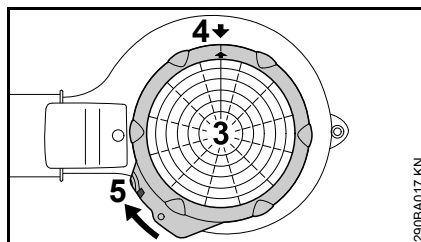

- Position the intake screen (3) on the intake opening.
- Line up the arrows (4).
- Rotate the intake screen (3) in direction of arrow until the lug (5) engages audibly on the blower housing.

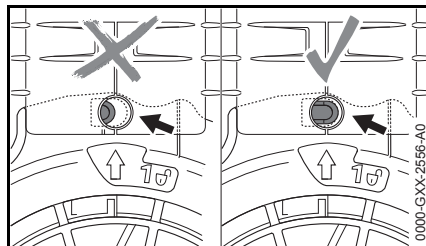

Lock button (arrow) must engage in position.

Connecting to Power Supply

The voltage and frequency of the machine (see rating plate) must match the voltage and frequency of the power connection.

The minimum fuse protection of the power connection must comply with the specifications – see "Specifications".

The machine must be connected to the power supply via an earth-leakage circuit breaker to disconnect the power supply if the differential current to earth exceeds 30 mA.

The power connection must correspond to IEC 60364 and relevant national regulations.

Extension cord

The design of the extension cord must at least fulfill the same features as the connecting cord on the machine. Observe the design marking (type designation) on the connecting cord.

The cores in the cord must have the following minimum cross-section depending on the mains voltage and cord length.

Cord length	Minimum cross-section
220 V – 240 V:	
Up to 20 m	1.5 mm ²
20 m to 50 m	2.5 mm ²
100 V – 127 V:	
Up to 10 m	AWG 14 / 2.0 mm ²
10 m to 30 m	AWG 12 / 3.5 mm ²

Strain relief (cord retainer)

The strain relief protects the appliance cord against damage.

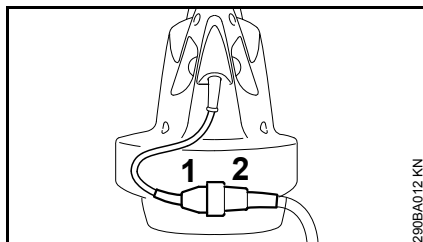

- Insert the plug (1) into the extension cord coupling (2).

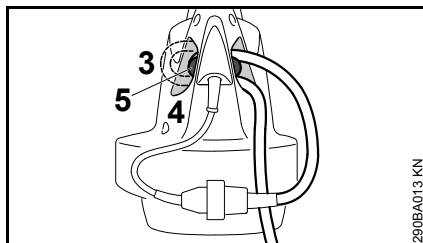

- Make a loop in the extension cord.
- Pass the loop (3) through the opening (4).
- Slip the loop over the hook (5) and pull it tight.

Connecting to Wall Outlet

Make sure your machine is switched off before you connect it to the power supply – see "Switching Off".

- Connect the extension cord plug to a properly installed wall outlet.

Switching On

- Make sure you have a secure and balanced footing.
- Hold the unit in the normal working position.

BGE 61, BGE 71, SHE 71

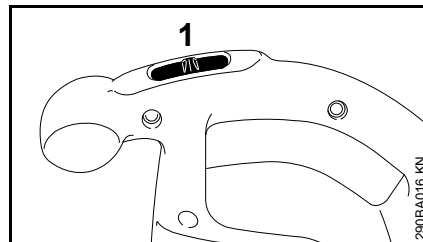

- Move switch (1) to I or II (position II depends on model).

Units with single switch setting (I):

I = full power

Units with two switch settings (I and II):

I = half power

II = full power

BGE 81, SHE 81

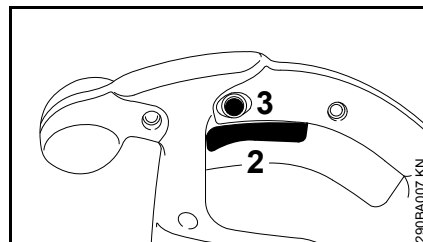

- Squeeze trigger switch (2) on control handle.

Blowing and suction power are infinitely variable.

Press in the lock button (3) to lock the trigger switch (2) in the maximum power position in the blower and vacuum modes.

Switching Off

During long work breaks – disconnect the plug from the power supply.

When the machine is not in use, shut it off so that it does not endanger others.

Secure it against unauthorized use.

BGE 61, BGE 71, SHE 71

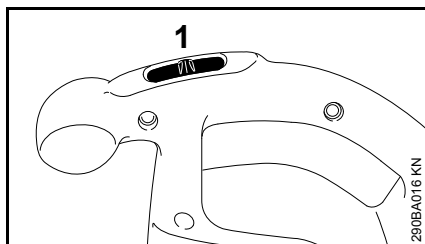

- Move the switch (1) to 0

BGE 81, SHE 81

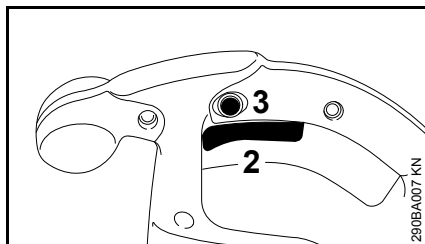

- Release trigger switch (2) on control handle.

If the lock button (3) is engaged, squeeze the trigger switch briefly and let it go.

Storing the Machine

- Thoroughly clean the machine.
- Store the machine in a dry, high or locked location, out of the reach of children and other unauthorized persons.

Maintenance and Care

The following intervals apply to normal operating conditions only. If your daily working time is longer or operating conditions are difficult (very dusty work area, etc.), shorten the specified intervals accordingly.		before starting work	after finishing work or daily	weekly	monthly	yearly	if problem	if damaged	if required
Complete machine	Visual inspection (condition)	x							
	Clean		x						
Control handle	Check operation	x							
Cooling inlets	Clean								x
Safety labels	Replace							x	

Minimize Wear and Avoid Damage

Observing the instructions in this manual helps reduce the risk of unnecessary wear and damage to the power tool.

The power tool must be operated, maintained and stored with the due care and attention described in this instruction manual.

The user is responsible for all damage caused by non-observance of the safety precautions, operating and maintenance instructions in this manual. This includes in particular:

- Alterations or modifications to the product not approved by STIHL.
- Using tools or accessories which are neither approved or suitable for the product or are of a poor quality.
- Using the product for purposes for which it was not designed.
- Using the product for sports or competitive events.
- Consequential damage caused by continuing to use the product with defective components.

Maintenance Work

All the operations described in the "Maintenance Chart" must be performed on a regular basis. If these maintenance operations cannot be performed by the owner, they should be performed by a servicing dealer.

STIHL recommends that you have servicing and repair work carried out exclusively by an authorized STIHL

servicing dealer. STIHL dealers are regularly given the opportunity to attend training courses and are supplied with the necessary technical information.

If these maintenance operations are not carried out as specified, the user assumes responsibility for any damage that may occur. Among other things, this includes:

- Damage to the motor due to neglect or deficient maintenance (e.g. not cleaning cooling air inlets).
- Damage due to incorrect electrical connection (voltage, inadequately rated connecting cords).
- Corrosion and other consequential damage resulting from improper storage.
- Damage to the product resulting from the use of poor quality replacement parts.

Parts Subject to Wear and Tear

Some parts of the power tool are subject to normal wear and tear even during regular operation in accordance with instructions and, depending on the type and duration of use, have to be replaced in good time. Among other parts, this includes:

- Fanwheel
- Catcher bag

Main Parts

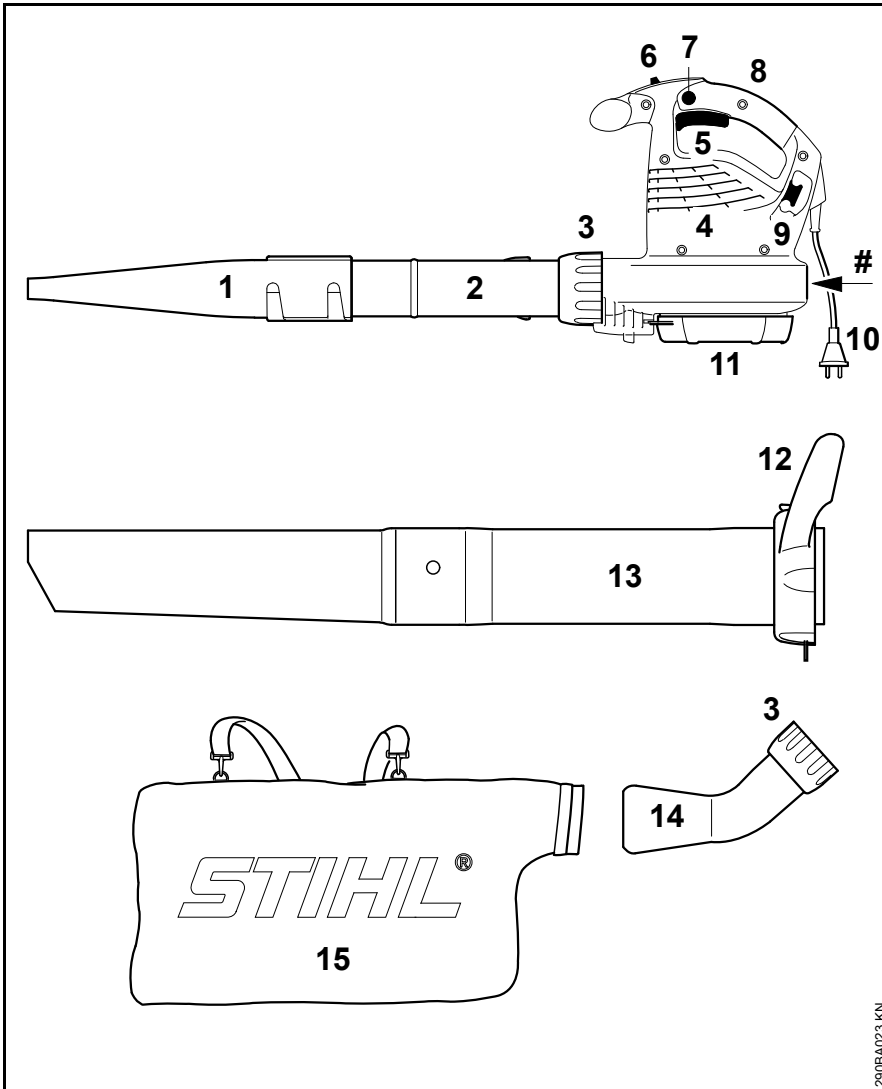

- 1 Fan nozzle
- 2 Blower tube
- 3 Union nut
- 4 Cooling inlets
- 5 Trigger (BGE 81, SHE 81 only)
- 6 Switch (BGE 61, BGE 71, SHE 71 only)
- 7 Lock button (BGE 81, SHE 81 only)
- 8 Control handle
- 9 Strain relief hook (cord retainer)
- 10 Appliance plug
- 11 Protective screen
- 12 Union nut with handle*
- 13 Suction tube*
- 14 Elbow*
- 15 Catcher bag*
- # Serial number

* Standard on SHE, special accessory for BGE

Specifications

Motor (BGE 61)

120V version

Power supply	120 V, 60 Hz, 9.2 A
Fuse	15 A
Rating	1100 W
Insulation	II <input type="checkbox"/>

240V version

Power supply	240 V, 50 Hz, 4.8 A
Fuse	10 A
Rating	1100 W
Insulation	II <input type="checkbox"/>

Motor (BGE 71 / SHE 71)

120V version

Power supply	120 V, 60 Hz, 9.2 A
Fuse	15 A
Rating	1100 W
Insulation	II <input type="checkbox"/>

230V version

Power supply	230 V, 50 Hz, 4.8 A
Fuse	10 A
Rating	1100 W
Insulation	II <input type="checkbox"/>

230V - 240V version

Power supply	230 V - 240 V, 50 Hz, 4.8 A
Fuse	10 A
Rating	1100 W
Insulation	II <input type="checkbox"/>

Motor (BGE 81 / SHE 81)

230V version

Power supply	230 V, 50 Hz, 6.1 A
Fuse	10 A
Rating	1400 W
Insulation	II <input type="checkbox"/>

230V - 240V version

Power supply	230 V - 240 V, 50 Hz, 6.1 A
Fuse	10 A
Rating	1400 W
Insulation	II <input type="checkbox"/>

Maximum air flow rate

	Blower mode	Vacuum mode
BGE 61	670 m ³ /h	- - -
BGE 71	670 m ³ /h	580 m ³ /h
BGE 81	750 m ³ /h	650 m ³ /h
SHE 71	670 m ³ /h	580 m ³ /h
SHE 81	750 m ³ /h	650 m ³ /h

Air velocity with nozzle

	Blower mode
BGE 61	66 m/s
BGE 71	66 m/s
BGE 81	76 m/s
SHE 71	66 m/s
SHE 81	76 m/s

Dimensions

Width	210 mm
Height	334 mm
Depth	330 mm

Weight

BGE 61	3.0 kg
BGE 71	3.0 kg
BGE 81	3.3 kg
SHE 71	4.1 kg
SHE 81	4.4 kg

Noise and Vibration Data

Noise and vibration data are determined on the basis of the rated maximum speed.

For further details on compliance with Vibration Directive 2002/44/EC visit www.stihl.com/vib.

Sound pressure level L_p to EN 506362100

	Blower mode	Vacuum mode
BGE 71	85 dB(A)	85 dB(A)
BGE 81	89 dB(A)	88 dB(A)
SHE 71	85 dB(A)	85 dB(A)
SHE 81	89 dB(A)	88 dB(A)

Sound power level L_w to EN 506362100

	Blower mode	Vacuum mode
BGE 71	100 dB(A)	101 dB(A)
BGE 81	103 dB(A)	103 dB(A)
SHE 71	100 dB(A)	101 dB(A)
SHE 81	103 dB(A)	103 dB(A)

Vibration level a_{hv} to EN 506362100

Blower mode

	Handle, right
BGE 71	1 m/s ²
BGE 81	4.1 m/s ²
SHE 71	1 m/s ²
SHE 81	4.1 m/s ²

Vacuum mode

	Handle, right	Handle, left
BGE 71	0.8 m/s ²	1.2 m/s ²
BGE 81	2.6 m/s ²	5.6 m/s ²
SHE 71	0.8 m/s ²	1.2 m/s ²
SHE 81	2.6 m/s ²	5.6 m/s ²

The K-factor in accordance with Directive 2006/42/EC is 2.0 dB(A) for the sound pressure level and sound power level; the K-factor in accordance with Directive 2006/42/EC is 2.0 m/s² for the vibration level.

REACH

REACH is an EC regulation and stands for the Registration, Evaluation, Authorisation and Restriction of Chemical substances.

For information on compliance with the REACH regulation (EC) No. 1907/2006 see www.stihl.com/reach.

Maintenance and Repairs

Users of this machine may only carry out the maintenance and service work described in this user manual. All other repairs must be carried out by a servicing dealer.

STIHL recommends that you have servicing and repair work carried out exclusively by an authorized STIHL servicing dealer. STIHL dealers are regularly given the opportunity to attend training courses and are supplied with the necessary technical information.

When repairing the machine, only use replacement parts which have been approved by STIHL for this power tool or are technically identical. Only use high-quality replacement parts in order to avoid the risk of accidents and damage to the machine.

STIHL recommends the use of original STIHL replacement parts.

Original STIHL parts can be identified by the STIHL part number, the **STIHL** logo and the STIHL parts symbol  (the symbol may appear alone on small parts).

Disposal

Observe all country-specific waste disposal rules and regulations.

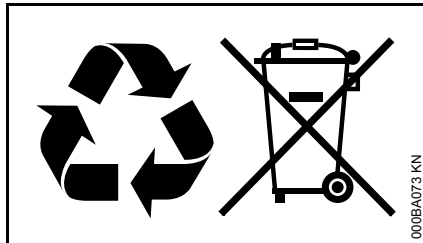

STIHL products must not be thrown in the garbage can. Take the product, accessories and packaging to an approved disposal site for environment-friendly recycling.

Contact your STIHL servicing dealer for the latest information on waste disposal.

EC Declaration of Conformity

ANDREAS STIHL AG & Co. KG
Badstr. 115
D-71336 Waiblingen

Germany

declare in exclusive responsibility that

Category: Electric blower, electric vacuum shredder
Make: STIHL
Model: BGE 61
BGE 71
BGE 81
SHE 71
SHE 81

Serial identification: 4811

conforms to the relevant provisions of Directives 2011/65/EU, 2006/42/EC, 2000/14/EU and 2014/30/EC and has been developed and manufactured in compliance with the following standards in the versions valid on the date of production:

EN 50636-2-100, EN 55014-1,
EN 55014-2, EN 60335-1,
EN 61000-3-2, EN 61000-3-3

The measured and guaranteed sound power levels were determined according to Directive 2000/14/EC, Annex V.

Measured sound power level

BGE 71: 98 dB(A)
BGE 81: 101 dB(A)
SHE 71: 98 dB(A)
SHE 81: 100 dB(A)

Guaranteed sound power level

BGE 71: 100 dB(A)
BGE 81: 103 dB(A)
SHE 71: 100 dB(A)
SHE 81: 102 dB(A)

Technical documents deposited at:

ANDREAS STIHL AG & Co. KG
Produktzulassung (Product Licensing)

The year of manufacture, country of manufacture and serial number are applied to the product.

Done at Waiblingen, 01.03.2017

ANDREAS STIHL AG & Co. KG

A handwritten signature in black ink that reads 'Thomas Elsner'.

Thomas Elsner

Director Product Management and Services



0458-290-0121-B

englisch



www.stihl.com



0458-290-0121-B