

FS 361 C-M, 411 C-M,
461 C-M

STIHL



2 - 24 Instruction Manual



Contents

1	Introduction.....	2
2	Guide to Using this Manual.....	2
3	Overview.....	3
4	Safety Precautions.....	4
5	Preparing Trimmer for Operation.....	11
6	Assembling the Trimmer.....	11
7	Adjusting Trimmer for User.....	14
8	Mixing Fuel and Refueling the Brushcutter	14
9	Starting and Stopping the Engine.....	15
10	Testing the Trimmer.....	16
11	Operating the Trimmer.....	16
12	After Finishing Work.....	19
13	Transporting.....	19
14	Storing.....	19
15	Cleaning.....	19
16	Maintenance.....	19
17	Repairing.....	20
18	Troubleshooting.....	20
19	Specifications.....	21
20	Combinations of Cutting Attachments, Deflectors and Carrying Systems.....	23
21	Spare Parts and Accessories.....	23
22	Disposal.....	23
23	EC Declaration of Conformity.....	23

1 Introduction

Dear Customer,

Thank you for choosing STIHL. We develop and manufacture our quality products to meet our customers' requirements. The products are designed for reliability even under extreme conditions.

STIHL also stands for premium service quality. Our dealers guarantee competent advice and instruction as well as comprehensive service support.

STIHL expressly commit themselves to a sustainable and responsible handling of natural resources. This user manual is intended to help you use your STIHL product safely and in an environmentally friendly manner over a long service life.

We thank you for your confidence in us and hope you will enjoy working with your STIHL product.



Dr. Nikolas Stihl

**IMPORTANT! READ BEFORE USING AND
KEEP IN A SAFE PLACE FOR REFERENCE.**

2 Guide to Using this Manual

2.1 Applicable Documentation

Local safety regulations apply.

- ▶ Read, understand and save the following documents in addition to this instruction manual:
 - Instruction manual and packaging of the cutting attachment you are using

2.2 Symbols used with warnings in the text

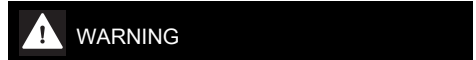

- This symbol indicates dangers that can cause serious injuries or death.
 - ▶ The measures indicated can avoid serious injuries or death.



- This symbol indicates dangers that can cause damage to property.
 - ▶ The measures indicated can avoid damage to property.

2.3 Symbols in Text



This symbol refers to a chapter in this instruction manual.

3 Overview

3.1 Brushcutter

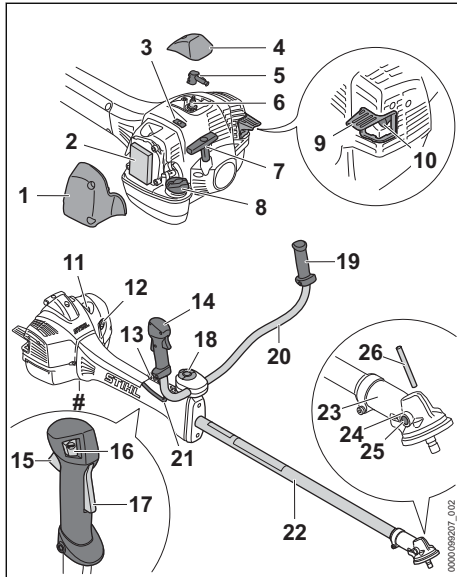

- 1 Filter cover**
Covers the air filter.
- 2 Air filter**
The air filter filters the air entering the engine.
- 3 Shutter**
The shutter is used to select summer or winter operating mode.
- 4 Cover**
Covers the spark plug.
- 5 Spark plug boot**
Connects the ignition lead to the spark plug.
- 6 Spark plug**
Ignites the fuel-air mixture in the engine.
- 7 Starter grip**
The starter grip is used for starting the engine.
- 8 Fuel tank cap**
The fuel tank cap closes the fuel tank.
- 9 Spacer**
The spacer prevents contact of the muffler with the ground.
- 10 Muffler with spark arresting screen**
Reduces brushcutter noise emissions.
- 11 Manual fuel pump**
The manual fuel pump makes it easier to start the engine.

12 Choke lever

The choke lever helps start the engine.

13 Carrying strip

Perforated strip for suspending the carrying system.

14 Control handle

The control handle is used for operating, holding and controlling the brushcutter.

15 Throttle trigger

The throttle trigger is used to control the engine speed.

16 Throttle trigger lockout

The throttle trigger lockout unlocks the throttle trigger.

17 Stop switch

The stop switch shuts off the engine.

18 Wing screw

The wing screw secures the handlebar to the handle support.

19 Handlebar

The handlebar connects control handle and handle with the shaft.

20 Handle

The handle is for holding and controlling the brushcutter.

21 Throttle cable

Connects the throttle trigger to the engine.

22 Shaft

The shaft connects all components.

23 Gear housing

The gear housing encloses the gearbox.

24 Opening for stop pin

The opening for the stop pin accommodates the stop pin.

25 Screw plug

The screw plug closes the filler opening for STIHL gear grease.

26 Stop pin

The stop pin blocks the shaft while a cutting attachment is being mounted.

Rating plate with machine number

3.2 Deflectors and Cutting Attachments

The illustrations show examples of deflectors and cutting attachments. Approved combinations are listed in this instruction manual,  20.

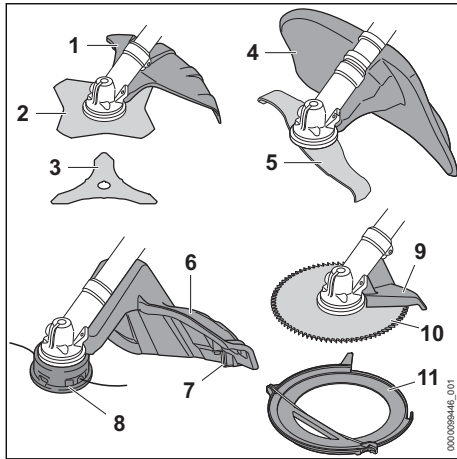

- 1 Deflector for metal cutting attachments**
The metal cutting tool guard protects the user from thrown objects and contact with the grass cutting blade or brush knife.
- 2 Grass Cutting Blade**
Cuts grass and weeds.
- 3 Brush knife**
Cuts brushwood.
- 4 Guard for shredder blades**
The shredder blade guard protects the user from thrown objects and from contact with the shredding blade.
- 5 Shredder blades**
The shredder blade cuts and shreds thickets.
- 6 Deflector for mowing heads**
Protects user from flying debris and contact with the mowing head.
- 7 Line limiting blade**
Line limiting blade trims nylon lines to correct length.
- 8 Mowing head**
Moving head accommodates the mowing lines.
- 9 Limit stop**
Protects user from flying debris and contact with the circular saw blade and helps support the trimmer against the wood during cutting work.
- 10 Circular Saw Blade**
Cuts shrubs and trees.
- 11 Transport guard**
The transport guard protects the user from contact with metal cutting attachments.

3.3 Icons

Meanings of symbols that may be on the trimmer and the deflector:



This icon denotes the fuel tank.



This symbol denotes the manual fuel pump.



Shutter is in winter mode in this position.



Shutter is in summer mode in this position.



Engine is operated or started with the choke control in this position.



Engine can be started with the choke control in this position.



This symbol marks the stop switch.



This icon shows the direction of rotation of the cutting attachment.

max \varnothing xxx This icon shows the maximum diameter of the cutting attachment in millimeters.



This icon shows the rated speed of the cutting attachment.



L_{WA} Guaranteed sound power level in accordance with Directive 2000/14/EC in dB(A) for the purpose of comparing the sound emissions of products.

4 Safety Precautions

4.1 Warning Signs

4.1.1 Warning Symbols

Meanings of warning signs on the trimmer:



Observe safety notices and take the necessary precautions.



Read, understand and save the instruction manual.



Wear safety glasses, hearing protection and a hard hat.



Wear safety boots.



Wear work gloves.



Observe safety notices on kickback and take the necessary precautions.



Observe safety notices on flying debris and take the necessary precautions.



Maintain safe distance.



Do not touch hot surface.

4.1.2 Deflector for mowing heads

Meanings of warning signs and labels on the deflector for mowing heads:



Use this deflector for mowing heads.



Do not use this deflector for grass cutting blades.



Do not use this deflector for brush knives.



Do not use this deflector for shredder blades.



Do not use this deflector for circular saw blades.

4.1.3 Deflector for metal cutting attachments

Meanings of warning signs on the deflector for metal cutting attachments:



Use this deflector for grass cutting blades.



Use use this deflector for brush knives.



Do not use this deflector for mowing heads.



Use this deflector for shredder blades.



Do not use this deflector for circular saw blades.

4.1.4 Guard for shredder blades

Meanings of warning signs and labels on the deflector for shredder blades:



Do not use this deflector for shredder blades.



Do not use this deflector for mowing heads.



Do not use this deflector for grass cutting blades.



Do not use this deflector for brush knives.



Do not use this deflector for circular saw blades.

4.2 Intended Use

The STIHL FS 361, FS 411 and FS 461 brushcutters are designed for the following applications:

- with a mowing head: Mowing grass
- with a grass cutting blade: Mowing grass and weeds
- with a brush knife: Cutting brush with a stem diameter up to 20 mm
- with a shredder blade: Mowing and shredding thickets with a diameter of up to 20 mm
- with a circular saw blade: Cutting shrubs and trees with a stem diameter up to 70 mm

▲ WARNING

- Using the brushcutter for purposes which it is not designed for may result in serious or fatal injuries and damage to property.
 - ▶ Use the brushcutter as described in this User Manual.

4.3 The Operator

▲ WARNING

- Users who have had no instruction cannot recognize or assess the risks involved in using the trimmer. The user or other persons may sustain serious or fatal injuries.



- ▶ Read, understand and save the instruction manual.

- ▶ If you pass the trimmer is on to another user: Always give them the instruction manual.
- ▶ Make sure the user meets the following requirements:
 - The user must be rested.
 - The user must be in good physical condition and mental health to operate and work with the trimmer. If the user's physical, sensory or mental ability is restricted, he or she may work only under the supervision of or as instructed by a responsible person.
 - The user is able to recognize and assess the risks involved in using the trimmer.
 - The user must be of legal age or is being trained in a trade under supervision in accordance with national rules and regulations.
 - The user has received instruction from a STIHL servicing dealer or other experienced user before working with the trimmer for the first time.
 - The user must not be under the influence of alcohol, medication or drugs.
- ▶ If you have any queries: Contact a STIHL servicing dealer for assistance.
- The trimmer's ignition system produces an electromagnetic field. This field may interfere with some pacemakers. This can result in serious or fatal injuries.
 - ▶ If the user has a pacemaker: Make sure the pacemaker is not affected.

4.4 Clothing and equipment

▲ WARNING

- Long hair can be drawn into the brushcutter during operation. This may result in serious injury to the user.
 - ▶ Tie up and confine long hair above your shoulders.
- Objects can be thrown at high speed during operation. This may result in injury to the user.



- ▶ Wear close-fitting safety glasses. Suitable safety glasses are tested in accordance with EN 166 or national regulations and available commercially with the corresponding marking.

- ▶ Wear face protection.
- ▶ Wear long trousers made from resistant material.

- Noise is generated during operation. Noise can damage your hearing.



- ▶ Wear ear protection.

- Falling objects can cause head injuries.



- ▶ If objects are likely to fall while working: wear a hard hat.

- Dust can be whipped up during operation. Whipped up dust can damage the respiratory passages and cause allergic reactions.

- ▶ If dust is generated: Wear a dust respirator mask.

- Inappropriate clothing can snag on wood, brush or the brushcutter. Users not wearing suitable clothing are at risk of serious injury.

- ▶ Wear close-fitting clothing.
- ▶ Remove scarves and jewelry.

- The user may come into contact with the rotating cutting attachment during operation. This may result in serious injury to the user.

- ▶ Wear robust footwear.



- ▶ If you are using a metal cutting attachment: Wear steel-toed safety boots.

- ▶ Wear long trousers made from resistant material.

- When mounting and dismantling the cutting attachment and during cleaning or maintenance, the user may come into contact with the sharp edges of the cutting attachment or the crosscut blade. This may result in injury to the user.



- ▶ Wear work gloves made from resistant material.

- Wearing unsuitable footwear may cause the user to slip. This may result in injury to the user.

- ▶ Wear sturdy, closed-toed footwear with high-grip soles.

4.5 Working Area and Surroundings

⚠ WARNING

- Bystanders, children and animals are not aware of the dangers of the brushcutter or flying debris. This may result in serious injury to bystanders, children and animals and damage to property.



- ▶ Do not allow bystanders, children or animals within 15 meters of the work area.

- ▶ Maintain a clearance of 15 meters from objects.
- ▶ Do not leave the brushcutter unattended.
- ▶ Make sure that children cannot play with the brushcutter.
- Hot exhaust gas is emitted through the muffler while the engine is running. Hot exhaust gas can ignite easily flammable materials and cause a fire.
 - ▶ Keep exhaust gas well away from easily flammable materials.

4.6 Safe Condition

4.6.1 Brushcutter

The brushcutter is in a safe condition if the following points are observed:

- The brushcutter is not damaged.
- There is no fuel leaking from the trimmer.
- The fuel tank cap is closed.
- The brushcutter is clean.
- The controls function properly and have not been modified.
- A combination of cutting attachment and deflector recommended in this user manual is mounted.
- The cutting attachment and deflector are properly mounted.
- Genuine STIHL accessories for this brushcutter are fitted.
- The accessories are correctly attached.
- All accessible screws and fastening parts are firmly tightened.
- Cutting attachment does not run while engine is idling.

⚠ WARNING

- If not in safe condition, components may no longer operate correctly, safety devices may be disabled and fuel leakage may occur. There is a risk of serious or fatal injury.
 - ▶ Work only with an undamaged brushcutter.

- ▶ If fuel is leaking from the trimmer: Do not use the trimmer and contact a STIHL dealer for assistance.
- ▶ Close the fuel tank cap.
- ▶ If the brushcutter is dirty: Clean the brushcutter.
- ▶ Never attempt to modify your brushcutter. Exception: Mounting one of the combinations of cutting attachment and deflector recommended in this user manual.
- ▶ If the controls do not function properly: Do not use your brushcutter.
- ▶ Fit genuine STIHL accessories for this brushcutter.
- ▶ Mount the cutting attachment and deflector as described in this user manual.
- ▶ Attach accessories as described in this User Manual or in the User Manual for the accessories.
- ▶ Tighten loose screws and fastening parts.
- ▶ If the cutting attachment rotates when the engine is idling: Rectify the malfunction.
- ▶ Never insert objects into the openings of the brushcutter.
- ▶ Replace worn or damaged labels.
- ▶ If you are unsure: Consult a STIHL servicing dealer.

4.6.2 Deflector

The deflector is in a safe condition if the following points are observed:

- The deflector is not damaged.
- The screws on the guard are tightened to the correct torque.
- If the guard is used for mowing heads: The line limiter blade is correctly installed.

⚠ WARNING

- If not in safe condition, components may no longer operate correctly and safety devices may be disabled. This may result in serious injury to the user.
 - ▶ Work only with an undamaged deflector.
 - ▶ Tighten the screws on the guard to the correct tightening torque, 6.2.
 - ▶ If the guard for mowing heads is used: Work with a properly attached cut-off blade.
 - ▶ If you have any doubts, be sure to consult a STIHL dealer.

4.6.3 Mowing Head

The mowing head is in a safe condition if the following points are observed:

- The mowing head is not damaged.
- The mowing head is not jammed.

- The mowing head is correctly installed and firmly tightened.
- The mowing lines are properly installed.
- The wear limits are not exceeded.

▲ WARNING

- If they are in an unsafe condition, parts of the mowing head or mowing lines may come off and be ejected at high speed. People may be seriously injured.
 - ▶ Work only with an undamaged mowing head.
 - ▶ Never use metal objects in place of the nylon mowing lines.
 - ▶ Observe and remain inside the wear limits.
 - ▶ If you are unsure: Consult a STIHL authorized dealer.

4.6.4 Metal cutting attachment

The metal cutting attachment is in a safe condition if the following points are observed:

- Metal cutting attachment and mounting hardware are undamaged.
- The metal cutting attachment is not warped.
- The metal cutting attachment is properly installed and firmly tightened.
- The metal cutting attachment is correctly sharpened.
- Cutting edges of the metal cutting attachment have no burrs.
- The wear limits are not exceeded.
- If a metal cutting attachment not manufactured by STIHL is used, it must not be heavier, thicker, of a different shape, of a lower quality, or larger in diameter than the largest metal cutting attachment approved by STIHL.

▲ WARNING

- If it is not in an safe condition, parts of the metal cutting attachment may come off and be thrown at high speed. People may be seriously injured.
 - ▶ Never work with a damaged metal cutting attachment or damaged mounting hardware.
 - ▶ Sharpen the metal cutting attachment correctly.
 - ▶ Deburr the cutting edges with a file.
 - ▶ Have the metal cutting attachment balanced by a STIHL servicing dealer.
 - ▶ Observe and remain inside the wear limits.
 - ▶ Use a metal cutting attachment specified in these instructions for use.
 - ▶ If you are unsure: Consult a STIHL authorized dealer.

4.7 Fuel Mixture and Refueling

▲ WARNING

- This brushcutter requires a fuel mixture of gasoline and two-stroke engine oil. Mixed fuel and gasoline are extremely flammable. If fuel mixture or gasoline make contact with open fire or hot objects, they can cause a fire or explosions. Persons may be seriously or fatally injured and property may be damaged.
 - ▶ Protect fuel mixture and gasoline from heat and fire.
 - ▶ Do not spill fuel mixture or gasoline.
 - ▶ If fuel is spilled: Wipe up fuel with a cloth and do not attempt to start engine until all parts of the brushcutter are dry.
 - ▶ Do not smoke.
 - ▶ Never refuel near a fire.
 - ▶ Shut off the engine and allow it to cool down before refueling.
 - ▶ Start the engine at least 3 meters from the fueling spot, outdoors only.
- Inhaling fuel fumes and gasoline fumes can have toxic effects.
 - ▶ Avoid inhaling fuel fumes or gasoline fumes.
 - ▶ Refuel in a well-ventilated location.
- The brushcutter becomes hot during operation. The fuel expands and excess pressure can build up in the tank. Fuel can escape as a spray when the fuel tank cap is opened. The escaping fuel can ignite. This may result in serious injury to the user.
 - ▶ Allow the brushcutter to cool down first and then open the fuel tank cap carefully.
- Clothing that has been in contact with fuel or gasoline will ignite more easily. Persons may be seriously or fatally injured and property may be damaged.
 - ▶ If your clothing comes into contact with fuel or gasoline: Change your clothing.
- Fuel mix, gasoline and two-stroke engine oil can harm the environment.
 - ▶ Do not spill fuel, gasoline or two-stroke engine oil.
 - ▶ Dispose of fuel mix, gasoline and two-stroke engine oil in accordance with local regulations and environmental requirements.
- Fuel, gasoline or two-stroke engine oil can cause irritation if they come into direct contact with the skin or eyes.
 - ▶ Avoid contact with fuel, gasoline and two-stroke engine oil.

- ▶ If skin contact occurs: Wash affected areas of skin with plenty of water and soap.
- ▶ If the event of contact with eyes: Rinse eyes with plenty of water for at least 15 minutes and consult a doctor.
- The brushcutter's ignition system produces sparks. Unconfined sparks may cause a fire or an explosion in an easily combustible or explosive environment. Persons may be seriously or fatally injured and property may be damaged.
 - ▶ Use the spark plugs described in this instruction manual.
 - ▶ Insert and tighten down the spark plug.
 - ▶ Connect the spark plug boot and press it down firmly.
- The brushcutter can become damaged if it is run with a fuel mixture that includes unsuitable gasoline or an unsuitable two-stroke engine oil, and also if an incorrect mix ratio of gasoline and two-stroke engine oil is used.
 - ▶ Mix the fuel as described in this User Manual.
- The mixture of gasoline and two-stroke engine oil can separate or age if it is stored for a long period. The brushcutter can be damaged if it is used with a fuel mix that has become separated or has aged.
 - ▶ Before refueling the brushcutter: Thoroughly mix the fuel.
 - ▶ Use a mixture of gasoline and two-stroke engine oil that is not older than 30 days (STIHL MotoMix: 5 years).

4.8 Working

▲ WARNING

- If the engine is not started properly, the user may lose control of the trimmer. This may result in serious injury to the user.
 - ▶ Start the engine as described in this instruction manual.
 - ▶ If the cutting attachment is touching the ground or objects: Do not start the engine.
- If the start flap lever is in the position ▲ when the engine is started, the engine speed is higher than the idle speed and the cutting attachment can rotate as soon as the engine is running. This may result in serious injury to the user.
 - ▶ Do not touch the cutting attachment.
 - ▶ Start the engine as described in this instruction manual.
- In certain situations, the user may no longer be able to concentrate on their work. The user can lose control of the trimmer, stumble or fall and be seriously injured.
 - ▶ Keep calm and plan your work.
 - ▶ If light and visibility are poor: Do not use your trimmer.
 - ▶ Operate the trimmer alone.
 - ▶ Keep the cutting attachment close to the ground.
 - ▶ Watch out for obstacles.
 - ▶ Work standing on the ground and keep your balance.
 - ▶ If you start feeling fatigue: Take a break. If you start feeling fatigue: Take a break.
- Exhaust gas is produced when the engine is running. Breathing in exhaust gas can have toxic effects. Breathing in exhaust gas can have toxic effects.
 - ▶ Avoid inhaling exhaust gas.
 - ▶ Operate the trimmer in a well ventilated location.
 - ▶ In the event of nausea, headache, visual disturbances, problems with hearing or dizziness: Stop work and seek medical advice.
- The user's ability to hear and assess noises is restricted when wearing hearing protection with the engine running.
 - ▶ Keep calm and plan your work.
- In case of working with the trimmer and the start flap lever is in the position ▲, the user cannot work with the power brush in a controlled manner. This may result in serious injury to the user.
 - ▶ Check that the choke lever is in position I during operation.
 - ▶ Start the engine as described in this instruction manual.
- The rotating cutting attachment can cut the user. This may result in serious injury to the user.
 - ▶ Do not touch the rotating cutting attachment.
 - ▶ If the cutting attachment is blocked by an object: Shut off the engine. Before clearing the jam.
- If you work with mowing lines that are too long, the brush cutter may be damaged.
 - ▶ Use a suitable deflector with attached line limiting blade.
- The machine can be damaged if you open the throttle while the cutting attachment is blocked by an object.
 - ▶ Shut off the engine. before clearing the jam.
- If the behavior of the trimmer changes during operation or feels unusual, it may no longer be

in a safe condition. This may result in serious injury to people and damage to property.

- ▶ Stop work and consult a STIHL servicing dealer.
- Trimmer vibrations may occur during operation.



- ▶ Wear gloves.

- ▶ Take breaks.
- ▶ If signs of a circulatory disturbance occur: Consult a doctor.
- If the cutting attachment makes contact with a foreign object during operation, the object or parts of it may be thrown at high speed. Persons may be injured or property damaged.
 - ▶ Remove foreign objects from the working area.
- If the rotating cutting attachment makes contact with a hard object, sparks may occur and the cutting attachment may be damaged. Sparks can cause fires in a flammable environment. Persons may be seriously or fatally injured and property may be damaged.
 - ▶ Do not use in a flammable environment.
 - ▶ Make sure the cutting attachment is in a safe condition.
- Note that the cutting attachment continues to rotate for a short period after you release the trigger. They may cause serious injury to persons.
 - ▶ Wait until the cutting attachment comes to a complete stop.
- In an emergency, the user may start to panic and forget to take off the carrying system. This may result in serious injury to the user.
 - ▶ Practice taking off the carrying system.

4.9 Reactive Forces

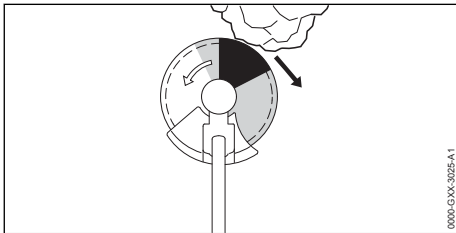

Kickout can be caused for the following reasons:

- The shaded area or the black area of the rotating metal cutting attachment comes into contact with a solid object and is suddenly braked.
- The rotating metal cutting attachment gets pinched in the cut.

The risk of kickout is greatest in the black area.

▲ WARNING

- These situations can abruptly decelerate or stop rotation of the cutting attachment and cause the cutting attachment to be thrown to the right or in the direction of the user (black arrow). The user can lose control of the trimmer. This can result in serious or fatal injuries.
 - ▶ Hold the trimmer firmly with both hands.
 - ▶ Use the working techniques described in this instruction manual.
 - ▶ Do not use the black area for cutting.
 - ▶ Use a combination of cutting attachment, deflector and carrying system recommended in this instruction manual.
 - ▶ Sharpen the metal cutting attachment correctly.
 - ▶ Cut with the motor running at full speed.

4.10 Transporting

▲ WARNING

- The gearbox can get hot during operation. There is a risk of burn injuries.
 - ▶ Do not touch a hot gearbox.
- The trimmer may turn over or shift during transport. This may result in personal injuries and damage to property.
 - ▶ Shut off the engine.
 - ▶ If a metal cutting attachment is mounted: Fit the transport guard.
 - ▶ Secure the trimmer with lashing straps or a net to prevent it turning over and moving.
- The muffler and engine may be hot after a period of operation. There is a risk of burn injuries.
 - ▶ Carry the trimmer properly balanced by the drive tube with the cutting attachment behind you.

4.11 Storing

▲ WARNING

- Children are not aware of and cannot assess the dangers of a trimmer and can be seriously injured.
 - ▶ Shut off the engine.
 - ▶ If a metal cutting attachment is mounted: Fit the transport guard.
 - ▶ Store the trimmer out of the reach of children.
 - ▶ Store the trimmer in a stable position and secured against falling over.

- Dampness can corrode the electrical contacts on the trimmer and metal components. This can damage the trimmer.
 - ▶ Store the trimmer in a clean and dry condition.

4.12 Cleaning, maintenance and repair

▲ WARNING

- The cutting attachment can start rotating unintentionally if the engine is running during cleaning, maintenance or repair operations. This may result in serious injury to people and damage to property.
 - ▶ Shut off the engine.
- The muffler and engine may be hot after a period of operation. This can result in burn injuries.
 - ▶ Wait until the muffler and engine cool down.
- The gear housing can get hot during operation. There is a risk of burn injuries.
 - ▶ Do not touch a hot gear housing.



- Aggressive cleaning agents, a water jet or pointed objects can damage the trimmer, deflector or the cutting attachment. If the trimmer, deflector and cutting attachment are not cleaned correctly, components may no longer function properly or safety devices may be rendered inoperative. Persons may be seriously injured.
 - ▶ Clean the brushcutter, deflector and cutting attachment as described in this User Manual.
- If the brushcutter, deflector or cutting attachment is not maintained or repaired as described in this User Manual, components may no longer function properly or safety devices may be rendered inoperative. This can result in serious or fatal injuries.
 - ▶ Maintain or repair the brushcutter and the deflector as described in this User Manual.
 - ▶ Maintain the cutting attachment as described in the User Manual supplied with the cutting attachment being used or on the cutting attachment's packaging.
- The user can be cut by the sharp cutting edges while cleaning or maintaining cutting attachments. This may result in injury to the user.



- ▶ Wear work gloves made of robust material.

5 Preparing Trimmer for Operation

5.1 Preparing the Brushcutter for Operation

The following steps must be performed before commencing work:

- ▶ Ensure that the following components are in safe condition:
 - Brushcutter, [15.1](#).
 - Deflector, [4.6.2](#).
 - Mowing head or metal cutting attachment, [4.6.3](#) or [4.6.4](#).
- ▶ Clean the brushcutter, [15.1](#).
- ▶ Mount the bike handle, [6.1](#).
- ▶ Select combination of cutting attachment, deflector and carrying system, [20](#).
- ▶ Mount the deflector, [6.2](#).
- ▶ Mount mowing head or metal cutting attachment, [6.3.1](#) or [6.4](#).
- ▶ Fuel the trimmer, [8.2](#).
- ▶ Fit and adjust the carrying system, [7.1](#).
- ▶ Adjust the bike handle, [7.2](#).
- ▶ Balance the brushcutter, [7.3](#).
- ▶ Check the controls, [10.1](#).
- ▶ If you cannot carry out this work: Do not use your brushcutter and contact your STIHL dealer for assistance.

6 Assembling the Trimmer

6.1 Mounting the Bike Handle

- ▶ Shut off the engine.

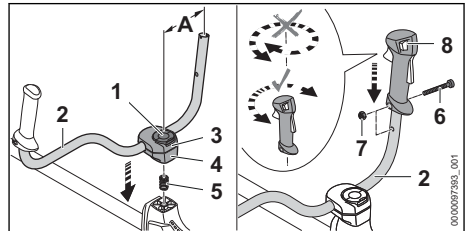

- ▶ Open the clamp of the toggle screw (1) and turn it counterclockwise until the handle tube (2) is only slightly clamped.
- ▶ Insert the spring (5) from below into the lower clamp molding (4).
- ▶ Place the clamp shells (3 and 4) on the shaft and insert the wing screw (1).

- ▶ Pivot the handlebar (2) up and align it so that distance (A) is about 16 cm.
In doing so, do not clamp the curved part of the handlebar (2).
- ▶ Tighten the wing screw (1) and close the clamp.
- ▶ Remove the screw (6).
- ▶ Position the control handle (8) on the handlebar (2), trigger facing the gear housing, and line up the hole in the control handle with the hole in the handlebar.
When doing so, do not twist the operating handle (8).
- ▶ Fit the nut (7).
- ▶ Insert and tighten down the screw (6) firmly.

It is not necessary to remove the bike handle again.

6.2 Removing the Deflector and the Limit Stop

6.2.1 Installing the Deflector and the Limit Stop

- ▶ Shut off the engine.

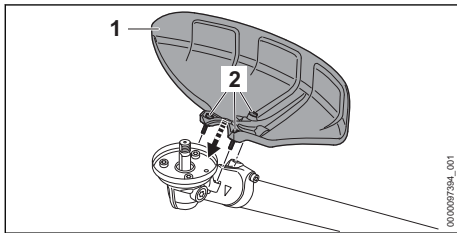

- ▶ Position the guard (1) on the gear housing.
- ▶ Insert the screws (2) and tighten them to a torque of 10 Nm.

6.2.2 Removing the Deflector and Limit Stop

- ▶ Shut off the engine.
- ▶ Take out screws.
- ▶ Remove deflector.

6.3 Mounting and Removing the Mowing Head

6.3.1 Mounting the Mowing Head

- ▶ Shut off the engine.

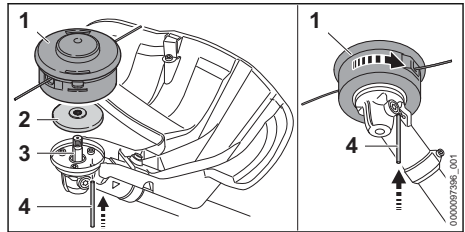

- ▶ Place the thrust plate (2) on the shaft (3) so that its smaller diameter faces up.
- ▶ Fit the mowing head (1) on the shaft (3) and turn it counterclockwise by hand.
- ▶ Insert the stop pin (4) in the bore up to the limit stop and hold it depressed.
- ▶ Turn the mowing head (1) counterclockwise until the stop pin (4) engages in position.
The shaft (3) is now blocked.
- ▶ Tighten down the mowing head (1) firmly by hand.
- ▶ Remove the stop pin (4).

6.3.2 Removing the Mowing Head

- ▶ Shut off the engine.
- ▶ Insert the stop pin in the bore as far as stop and hold it depressed.
- ▶ Rotate the mowing head until the stop pin engages in position.
The shaft is now blocked.
- ▶ Unscrew the mowing head clockwise.
- ▶ Remove the thrust plate.
- ▶ Remove stop pin.

6.4 Removing and Installing Metal Cutting Attachment

6.4.1 Mounting grass cutting blade, brush knife or circular saw blade

- ▶ Shut off the engine.

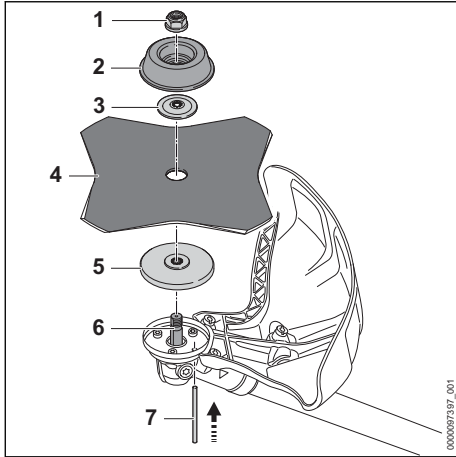

- ▶ Place the thrust plate (5) on the shaft (6) so that its smaller diameter faces up.
- ▶ Place the metal cutting attachment (4) on the thrust plate (5). If you are fitting a circular saw blade or a grass cutting blade with more than 4 cutting edges: Its cutting edges must face in the same direction as the arrow on the deflector.
- ▶ Place the thrust washer (3) on the metal cutting attachment (4) so that its raised side faces up.
- ▶ Place the rider plate (2) on the thrust washer (3) so that its closed side faces up.
- ▶ Insert the stop pin (7) in the bore up to the limit stop and hold it depressed.
- ▶ Rotate the metal cutting attachment (4) counterclockwise until the stop pin (7) engages in position.
The shaft (6) is now blocked.
- ▶ Fit the nut (1) counterclockwise and tighten it down firmly.
- ▶ Remove the stop pin (7).

6.4.2 Mounting Shredder Blade

- ▶ Shut off the engine.

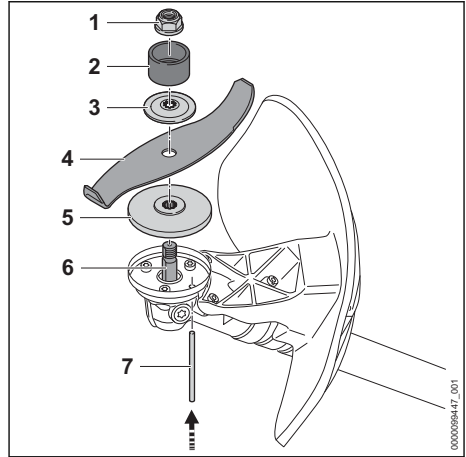

- ▶ Place the thrust plate (5) on the shaft (6) so that its smaller diameter faces up.
- ▶ Place the metal cutting attachment (4) on the thrust plate (5). If a shredder blade is used: Align cutting edges so that they point away from the gear unit in the direction of the nut (1).
- ▶ Place the thrust washer (3) on the metal cutting attachment (4) so that its raised side faces up.
- ▶ Place the protective ring (2) on the thrust washer (3) so that the opening points upwards.
- ▶ Insert the stop pin (7) in the bore as far as stop and hold it depressed.
- ▶ Rotate the metal cutting attachment (4) counterclockwise until the stop pin (7) engages in position.
The shaft (6) is now blocked.
- ▶ Fit the nut (1) counterclockwise and tighten it down firmly.
- ▶ Remove the stop pin (7).

6.4.3 Removing the metal cutting attachment

- ▶ Shut off the engine.
- ▶ Insert the stop pin in the bore up to the limit stop and hold it depressed.
- ▶ Rotate the metal cutting attachment clockwise until the stop pin engages in position.
The shaft is now blocked.
- ▶ Unscrew the mounting nut clockwise.
- ▶ Remove the fastening parts, metal cutting tool and pressure plate.
- ▶ Remove the stop pin.

7 Adjusting Trimmer for User

7.1 Fitting and Adjusting the Full Harness

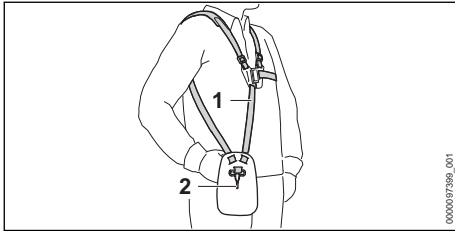

- ▶ Putting on the Full harness (1).
- ▶ Adjust the full harness (1) so that the carabiner (2) is about a hand's width below your right hip.

7.2 Adjusting the Bike Handle

The bike handle can be set to different positions to suit the height and reach of the user.

- ▶ Shut off the engine.
- ▶ Hook the brushcutter from the carrying strip into the carabiner of the carrying system.

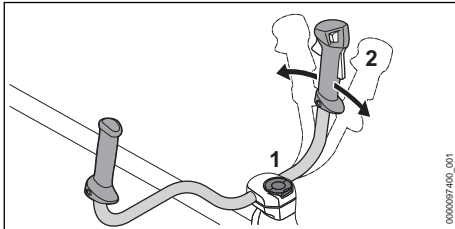

- ▶ Loosen the wing screw (1).
- ▶ Swing the bike handle (2) to the required position.
- ▶ Tighten down the wing screw (1) firmly.

7.3 Balancing the Brushcutter

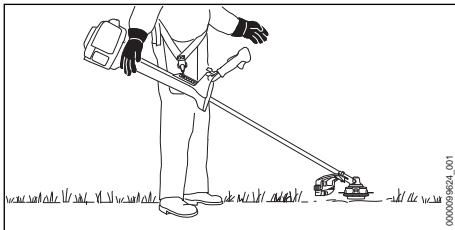

The cutting attachment should rest lightly on the ground.

- ▶ Shut off the engine.

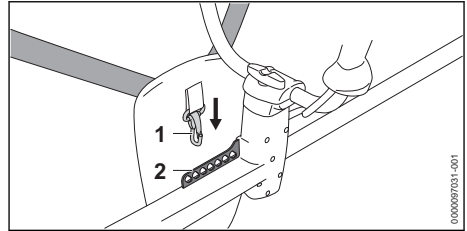

- ▶ Hook the carrying strip (2) onto the carabiner (1).
- ▶ Wait for brushcutter to stop swinging.
- ▶ Check the position of cutting attachment. If it needs adjustment: Hook the carabiner (1) into another hole in the hole bar (2) and let it swing out again.

8 Mixing Fuel and Refueling the Brushcutter

8.1 Mixing fuel

The fuel required for this trimmer is a mixture of gasoline and two-stroke engine oil, in a mixing ratio of 1:50.

STIHL recommends you use STIHL MotoMix.

If you mix the fuel yourself, use only STIHL two-stroke engine oil or another high-performance engine oil in accordance with JASO FB, JASO FC, JASO FD, ISO-L-EGB, ISO-L-EGC or ISO-L-EGD.

STIHL specifies STIHL HP Ultra two-stroke engine oil or an equivalent high-performance engine oil in order to maintain emission limits over the machine's service life.

- ▶ Make sure that the octane number of the gasoline is at least 90 RON and the ethanol content is not more than 10% (for Brazil: 27%).
- ▶ Make sure the two-stroke engine oil you are using meets requirements.
- ▶ Depending on the desired amount of fuel, determine the correct amounts of two-stroke engine oil and gasoline in a mixing ratio of 1:50. Examples for fuel mixes:
 - 20 ml Two-stroke engine oil, 1 l gasoline
 - 60 ml Two-stroke engine oil, 3 l gasoline
 - 100 ml Two-stroke engine oil, 5 l gasoline
- ▶ Pour two-stroke engine oil into a clean approved fuel canister first and then add gasoline.
- ▶ Stir the fuel before topping up.

8.2 Fueling the brushcutter

- ▶ Shut off the engine.

- ▶ Place your brushcutter on a level surface so that the fuel tank cap faces up.
- ▶ Use a damp cloth to clean the fuel tank cap and the area around it.

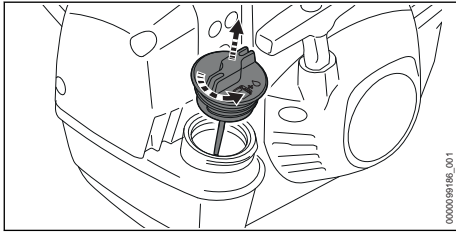

- ▶ Turn the tank cap counterclockwise until it can be removed.
- ▶ Remove the fuel tank cap.

NOTICE

- Exposure to light, direct sunlight and extreme temperatures may accelerate fuel separation or aging. The brushcutter can be damaged if it is used with a fuel mix that has become separated or has aged.
 - ▶ Thoroughly mix the fuel.
 - ▶ Do not top up with fuel stored for more than 30 days (STIHL MotoMix: 5 years).

- ▶ When topping up, ensure that no fuel is spilled and that the fuel level remains at least 15 mm under the edge of the tank.

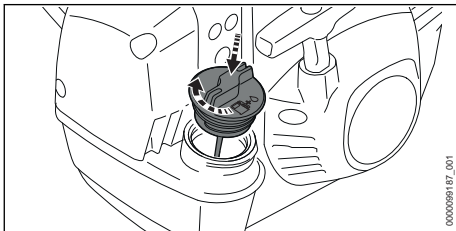

- ▶ Fit the fuel tank cap on the tank opening.
- ▶ Turn the tank cap clockwise and tighten it down firmly by hand.
The fuel tank is closed.

9 Starting and Stopping the Engine

9.1 Starting the engine

- ▶ Place the trimmer on a level surface so that the cutting attachment does not touch the ground or other objects.
- ▶ Remove the transport guard.

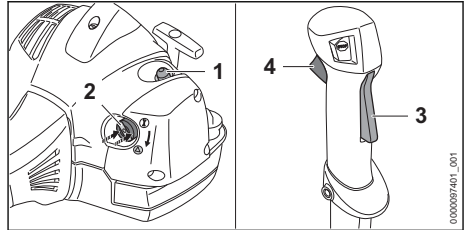

- ▶ Depress the manual fuel pump (1) at least 5 times.
- ▶ If the engine is warm: Leave the choke lever (2) in position **I**.
- ▶ If the engine is at ambient temperature: Push in the choke lever (2) at the edge and set it in position **▲**.



NOTICE

- The brushcutter can be damaged if you press it into the ground with your foot or knee.
 - ▶ Press the brushcutter against the ground with your left hand. Do not stand or kneel on the shaft.
- ▶ Press the brushcutter against the ground with your left hand.
- ▶ Pull the starter grip slowly with your right hand until you feel it engage.
- ▶ Pull the starter grip quickly and allow the starter rope to rewind several times until the engine runs.
- ▶ If the choke lever (2) is in the position **▲**: briefly press the throttle lever lockout (3) and the throttle trigger (4).
The choke lever (2) springs to position **I**. The engine runs at idling speed.
- ▶ If the engine is cold: Warm up engine by briefly opening the throttle.
- ▶ If the cutting attachment rotates when the engine is idling: Rectify the malfunction. Throttle cable adjustment is not correct.
- ▶ If the engine does not start: Move the choke lever (2) to position **▲** and try again to start the engine.

- ▶ If the engine is flooded: Try to start the engine again with the choke lever (2) in the **I** position.

9.2 Shut off the engine

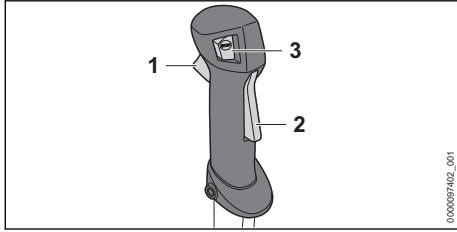

- ▶ Release the throttle trigger (1) and throttle trigger lockout (2). The cutting attachment comes to a standstill.
- ▶ Depress the stop switch (3). The engine stops.
- ▶ If the engine does not stop:
 - ▶ Move the choke lever to position **▲**. The engine stops.
 - ▶ Do not use your trimmer and contact a STIHL servicing dealer for assistance. There is a malfunction in the brushcutter.

As long as the stop switch is pressed, the ignition is switched off. After the stop switch has been released again, the ignition is switched on again.

10 Testing the Trimmer

10.1 Checking the controls

Throttle trigger lockout and throttle trigger

- ▶ Shut off the engine.
- ▶ Attempt to pull the trigger without depressing the lockout lever.
- ▶ If the trigger can be pulled: Do not use your trimmer and contact your STIHL dealer for assistance. The throttle trigger lockout is defective.
- ▶ Press the throttle trigger lockout and keep pressed.
- ▶ Depress the throttle trigger.
- ▶ Release the throttle trigger and throttle trigger lockout.
- ▶ If the trigger or trigger lockout is stiff or does not spring back to the idle position: Do not use your trimmer and contact your STIHL dealer for assistance. Throttle trigger lockout is faulty.

Throttle cable adjustment

- ▶ Start the engine.
- ▶ Attempt to pull the trigger without depressing the lockout lever.

- ▶ If the engine accelerates: Adjust the throttle cable. Throttle cable adjustment is not correct.

Shut off the engine

- ▶ Start the engine.
- ▶ Depress the stop switch. The engine stops.
- ▶ If the engine does not stop:
 - ▶ Move the choke lever to position **▲**. The engine stops.
 - ▶ Do not use your trimmer and contact a STIHL servicing dealer for assistance. The brushcutter is defective.

11 Operating the Trimmer

11.1 Setting to winter mode

The carburetor may ice up if the engine is operated at temperatures below +10 °C. The shutter must be set to the winter mode so that the carburetor is additionally heated by warm air from around the engine.

NOTICE

- ▶ The engine may overheat if is operated in winter mode at temperatures above +10 °C.
 - ▶ Change setting to summer mode.
- ▶ Shut off the engine.

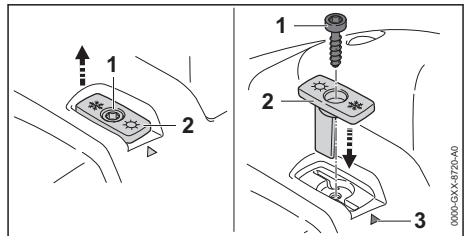

- ▶ Take out the screw (1).
- ▶ Pull out the shutter (2).
- ▶ Hold the shutter (2) so the snowflake points to the mark (3).
- ▶ Insert the shutter (2).
- ▶ Fit the screw (1).

When working at temperatures below -10°C or in powder or drifting snow, a cover plate must also be fitted to the engine housing and an air filter with plastic webbing. The accessories are available from a STIHL servicing dealer.

11.2 Summer Operation

The shutter must be set to summer mode when working at temperatures above +10°C.

- ▶ Shut off the engine.

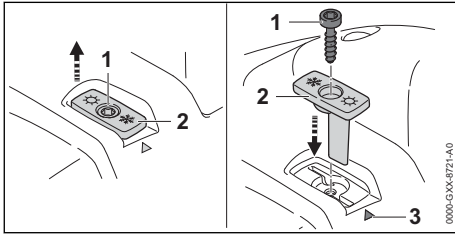

- ▶ Take out the screw (1).
- ▶ Pull out the shutter (2).
- ▶ Hold the shutter (2) so the sun points to the mark (3).
- ▶ Fit the shutter.
- ▶ Fit the screw (1).

11.3 Calibrating the brushcutter

The trimmer adjusts itself automatically for optimum performance during operation. Calibration enables the brushcutter to be adjusted to run faster for optimum performance.

- ▶ If the outside temperature is below -10°C or the engine is cold:
 - ▶ Start the engine.
 - ▶ Fit the carrying system.
 - ▶ Hold and guide the brushcutter.
 - ▶ Warm up the engine at full throttle for about 1 minute.
 - ▶ Shut off the engine.
- ▶ Remove the cutting attachment. This allows the brushcutter to reliably adjust itself to the optimum performance.

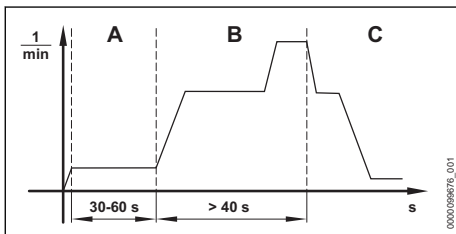

- ▶ Move the choke lever to position ▲.
- ▶ Start the engine without depressing the throttle trigger. The engine runs and the choke lever remains in position ▲.
- ▶ Run the engine for at least 30 seconds but no more than 60 seconds (A) without depressing the throttle trigger.
- ▶ Hold and guide the brushcutter in such a way that the gearbox does not touch the ground or other objects.

NOTICE

- The calibration process is aborted if the throttle trigger is released before the trigger is properly calibrated. It is then necessary to restart the calibration process.
 - ▶ Keep the throttle trigger fully depressed.

NOTICE

- The trimmer can be incorrectly calibrated if the throttle trigger is not kept fully depressed during calibration. This can damage the brushcutter.
 - ▶ Keep the throttle trigger fully depressed.
- ▶ Depress the throttle trigger for at least 40 seconds (B) and hold it in that position. The engine accelerates and the trimmer is calibrated. The engine speed fluctuates and increases perceptibly during calibration.
- ▶ If the engine stalls: Make another attempt to calibrate the trimmer.
- ▶ If the engine stops repeatedly: Do not use your trimmer and contact your STIHL servicing dealer for assistance. The brushcutter is defective.
- ▶ As soon as the engine speed drops noticeably (C): Release the throttle trigger. The engine runs at idling speed. The brushcutter is calibrated and ready for use.
- ▶ Shut off the engine.
- ▶ Mount the cutting attachment.

11.4 Holding and Controlling the Brushcutter

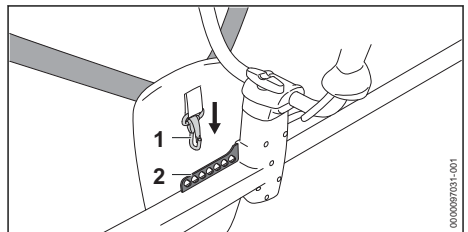

- ▶ Hook the carrying strip (2) onto the carabiner (1).

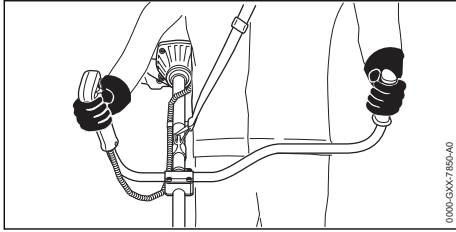

- ▶ Hold the brushcutter firmly with your right hand on the control handle – wrap your thumb around the handle.
- ▶ Hold the brushcutter with your left hand on the left grip in such a way that your thumb encloses the handle.

11.5 Mowing

The cutting height is determined by the distance of the cutting attachment from the ground.

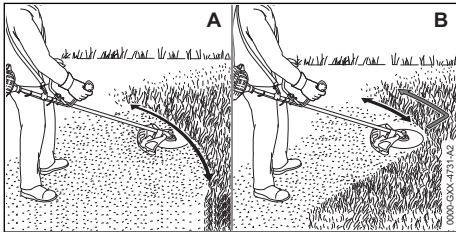

Mowing with a mowing head (A)

- ▶ Swing the brushcutter steadily back and forth in an arc.
- ▶ Move forward slowly in a controlled manner.

Mowing with a grass cutting blade or brush knife (B)

- ▶ Mow with the left-hand side on the metal cutting attachment.
- ▶ Move forward slowly in a controlled manner.

11.6 Thinning with a brush knife or shredder blade

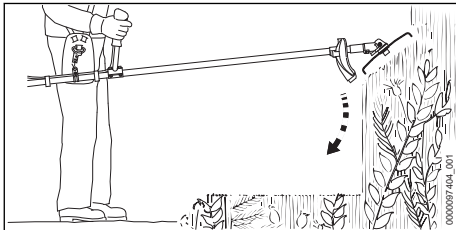

- ▶ Dip the metal cutting attachment into the thicket from above.

- ▶ Do not lift metal cutting tool above waist height.

11.7 Saws with a circular saw blade

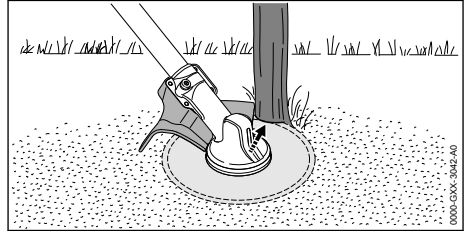

- ▶ Support the left side of the deflector against the stem.
- ▶ Cut through the stem at full speed.
- ▶ A safety distance of at least 2 tree lengths to the next work area.

11.8 Adjusting Nylon Line

11.8.1 Line Feed on AutoCut Mowing Head

- ▶ Tap the rotating mowing head on the ground. About 30 mm of fresh nylon line is advanced. The line limiting blade in the deflector trims the mowing lines to the correct length.

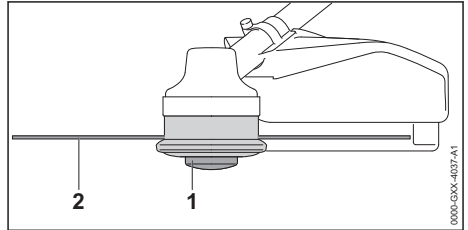

Automatic feed does not operate if the mowing lines are shorter than 25 mm.

- ▶ Shut off the engine.
- ▶ Depress the spool (1) on the mowing head and hold it depressed.
- ▶ Pull out the mowing lines (2).
- ▶ If the mowing lines (2) cannot be pulled out to the required length: Replace the spool (1) or the mowing lines (2). The spool is empty.

11.8.2 Line Feed on SuperCut Mowing Heads

Mowing lines are adjusted automatically. The line limiting blade in the deflector trims the mowing lines to the correct length.

Automatic feed will not take place if the mowing lines are shorter than 40 mm.

- ▶ Shut off the engine.
- ▶ Pull out the mowing lines.
- ▶ If the mowing lines cannot be pulled out to required length: Replace nylon line. The spool is empty.

12 After Finishing Work

12.1 When Work is Finished

- ▶ Shut off the engine.
- ▶ Allow trimmer to cool down.
- ▶ If the brushcutter is wet: Allow the brushcutter to dry.
- ▶ Clean the brushcutter.
- ▶ Clean the deflector.
- ▶ Clean the cutting attachment.
- ▶ If a metal cutting attachment is mounted: Fit the matching transport guard.

13 Transporting

13.1 Transporting the Trimmer

- ▶ Shut off the engine.
- ▶ If a metal cutting attachment is mounted: Fit the matching transport guard.

Carrying the trimmer

- ▶ Carry the trimmer properly balanced by the drive tube with the cutting attachment behind you.

Transporting the trimmer in a vehicle

- ▶ Secure the trimmer to prevent turnover and movement.

14 Storing

14.1 Storing the Brushcutter

- ▶ Shut off the engine.
- ▶ If a metal cutting attachment is mounted: Fit the matching transport guard.

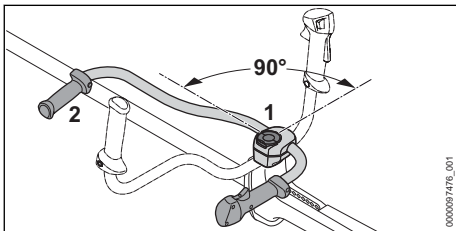

- ▶ Loosen the wing screw (1) and unscrew it until the handlebar (2) can be rotated.
- ▶ Turn the handlebar (2) clockwise through 90° and fold it down.
- ▶ Tighten down the wing screw (1) firmly.
- ▶ Ensure that the following conditions are met when storing the brushcutter:

- The brushcutter is out of the reach of children.
- The brushcutter is clean and dry.
- ▶ If you store the trimmer for more than 30 days:
 - ▶ Remove the cutting attachment.
 - ▶ Open the fuel tank cap.
 - ▶ Drain the fuel tank.
 - ▶ Close the fuel tank.
 - ▶ If a manual fuel pump is fitted: Press the manual fuel pump at least 5 times.
 - ▶ Start the engine and run it at idling speed until it stops.

15 Cleaning

15.1 Cleaning the Trimmer

- ▶ Shut off the engine.
- ▶ Allow trimmer to cool down.
- ▶ Clean the trimmer with a damp cloth or STIHL resin solvent.
- ▶ Clean cooling air slots with a soft brush.

15.2 Cleaning the Deflector and Cutting Attachment

- ▶ Shut off the engine.
- ▶ Clean the deflector and cutting attachment with a damp cloth or a soft brush.

16 Maintenance

16.1 Maintenance intervals

Maintenance intervals depend on the ambient conditions and the operating conditions. STIHL recommends the following maintenance intervals:

Before mounting a cutting attachment

- ▶ Check whether gear grease has leaked from the shaft.
- ▶ If gear grease has leaked out: Have the level in the gear housing checked by a STIHL servicing dealer.

After every 100 hours of operation

- ▶ Replace the spark plug.

Monthly

- ▶ Have the fuel tank cleaned by a STIHL dealer.
- ▶ Have the pickup body in the fuel tank cleaned by a STIHL dealer.

Annually

- ▶ Have the pickup body in the fuel tank replaced by a STIHL dealer.

16.2 Sharpening and Balancing a Metal Cutting Attachment

Correctly sharpening and balancing metal cutting attachments requires a lot of practice.

STIHL recommends you have metal cutting attachments resharpened and balanced by a STIHL servicing dealer.

- ▶ Sharpen the metal cutting attachment as described in the instructions and on the pack-

aging supplied with the cutting attachment you are using.

17 Repairing

17.1 Repairing the Trimmer and Cutting Attachment

The trimmer and cutting attachment cannot be repaired by the user.

- ▶ If the trimmer or cutting attachment is damaged: Do not use your trimmer or cutting attachment and contact your STIHL servicing dealer.

18 Troubleshooting

18.1 Troubleshooting the Brushcutter

Most problems can be attributed to the same cause.

- ▶ Carry out the following measures:
 - ▶ Replace the air filter.
 - ▶ Clean or replace the spark plug.
 - ▶ Adjust for winter or summer operation.
- ▶ If the problem continues: Carry out the measured listed below.

Fault	Cause	Remedy
The engine does not start.	There is not enough fuel in the fuel tank.	▶ Prepare fuel mix and refuel the trimmer.
	The carburetor is too hot.	▶ Allow trimmer to cool down. ▶ Depress the manual fuel pump at least 10 times before starting the engine.
	The carburetor has iced up.	▶ Allow brushcutter to warm up to +10°C.
The engine idles erratically.	The carburetor has iced up.	▶ Allow brushcutter to warm up to +10°C.
The engine stops while idling.	The carburetor has iced up.	▶ Allow brushcutter to warm up to +10°C.
Cutting attachment runs while engine is idling.	Throttle cable adjustment is not correct.	▶ Adjust the throttle cable.
The engine does not reach maximum speed.	Trimmer is not correctly tuned to ambient conditions.	▶ Calibrate the brushcutter.
	Throttle cable adjustment is not correct.	▶ Adjust the throttle cable.
The engine switches off although there is still fuel in the fuel tank.	The pickup body is not located in the right place.	▶ Contact a STIHL servicing dealer.
Engine does not reach maximum power.	Spark arresting screen in muffler is dirty.	▶ Contact a STIHL servicing dealer.

18.2 Replacing air filter

- ▶ Move the choke lever to position ▲.

The air filter cannot be cleaned. The air filter must be replaced if it is damaged or there is a loss of engine power.

- ▶ Shut off the engine.

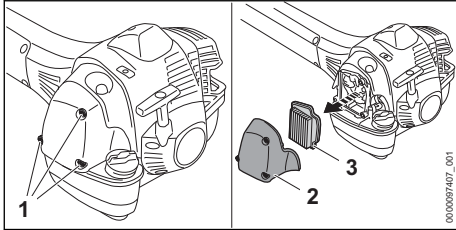

- ▶ Take out the screws (1) and remove the filter cover (2).
- ▶ Clean the area around the air filter (3) with a damp cloth or a soft brush.
- ▶ Take out the air filter (3).
- ▶ Install the new air filter (3).
- ▶ Fit the filter cover (2).
- ▶ Insert screws (1) and tighten.

18.3 Cleaning the Spark Plug

- ▶ Shut off the engine.
- ▶ Allow trimmer to cool down.

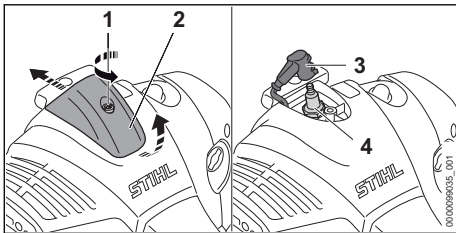

- ▶ Turn screw (1) counterclockwise.
- ▶ Lift the cover (2) and push it backwards.
- ▶ Pull off the spark plug boot (3).
- ▶ If the area around the spark plug (4) is soiled: Clean the spark plug (4) with a cloth.
- ▶ Unscrew the spark plug (4).
- ▶ Clean the spark plug (4) with a cloth.
- ▶ If the spark plug (4) is corroded: Install a new spark plug (4).
- ▶ Insert and tighten down the spark plug (4) firmly.
- ▶ Press the spark plug boot (3) firmly home.
- ▶ Install cover (2) and tighten screw (1).

18.4 Adjusting the Throttle Cable

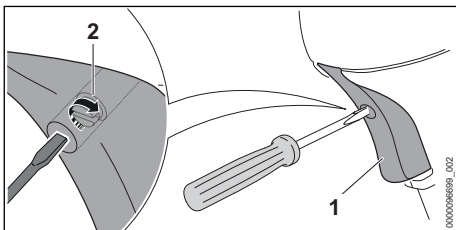

- ▶ Press the throttle trigger (1) and keep pressed.
- ▶ Turn screw (2) clockwise until resistance is felt.
- ▶ Turn the screw (2) clockwise through another half-turn.

19 Specifications

19.1 STIHL FS 361 C-M Brushcutter

- Displacement: 37.7 cm³
- Engine power according to ISO 8893: 1.7 kW (2.3 hp) at 8,500 rpm
- Idle speed: 2,700 rpm
- Max. output shaft speed: 7,100 rpm
- Approved spark plug: NGK CMR6H from STIHL
- Electrode gap of the spark plug: 0.5 mm
- Dry weight without cutting attachment and deflector: 8.6 kg
- Length without cutting attachment: 1786 mm
- Max. fuel tank capacity: 750 cm³ (0.75 l)

19.2 STIHL FS 411 C-M Brushcutter

- Displacement: 41.6 cm³
- Engine power according to ISO 8893: 2.0 kW (2.7 hp) at 9,000 rpm
- Idle speed: 2,700 rpm
- Max. output shaft speed: 7,100 rpm
- Approved spark plug: NGK CMR6H from STIHL
- Electrode gap of the spark plug: 0.5 mm
- Weight with empty fuel tank and without cutting attachment and deflector:
 - FS 411 C-M: 8.7 kg
 - FS 411 C-M L: 8.8 kg
- Length without cutting attachment:
 - FS 411 C-M: 1786 mm
 - FS 411 C-M L: 1846 mm
- Max. fuel tank capacity: 750 cm³ (0.75 l)

19.3 STIHL FS 461 C-M Brushcutter

- Displacement: 45.6 cm³
- Engine power according to ISO 8893: 2.2 kW (3.0 hp) at 9,500 rpm
- Idle speed: 2,700 rpm
- Max. output shaft speed: 7,100 rpm
- Approved spark plug: NGK CMR6H from STIHL
- Electrode gap of the spark plug: 0.5 mm
- Weight with empty fuel tank and without cutting attachment and deflector:
 - FS 461 C-M: 8.7 kg
 - FS 461 C-M L: 8.8 kg
- Length without cutting attachment:
 - FS 461 C-M: 1786 mm
 - FS 461 C-M L: 1846 mm

- Max. fuel tank capacity: 750 cm³ (0.75 l)

19.4 Sound Values and Vibration Values

The K-value for the sound pressure levels is 2 dB(A). The K-value for the sound power levels is 2 dB(A). The K-value for vibration level is 2 m/s².

Using with a mowing head

FS 361 C-M

- Sound pressure level L_{pA} measured according to ISO 22868: 100 dB(A).
- Sound power level L_w measured according to ISO 22868: 109 dB(A)
- Vibration level a_{hv} measured according to ISO 22867:
 - Control handle: 2.3 m/s².
 - Left handle: 2.6 m/s².

FS 411 C-M

- Sound pressure level L_{pA} measured according to ISO 22868: 100 dB(A).
- Sound power level L_w measured according to ISO 22868: 110 dB(A)
- Vibration level a_{hv} measured according to ISO 22867:
 - Control handle: 2.3 m/s².
 - Left handle: 1.9 m/s².

FS 461 C-M

- Sound pressure level L_{pA} measured according to ISO 22868: 101 dB(A).
- Sound power level L_w measured according to ISO 22868: 110 dB(A)
- Vibration level a_{hv} measured according to ISO 22867:
 - Control handle: 2.7 m/s².
 - Left handle: 1.9 m/s².

Using with a metal cutting attachment

FS 361 C-M

- Sound pressure level L_{pA} measured according to ISO 22868: 100 dB(A).
- Sound power level L_w measured according to ISO 22868: 110 dB(A)
- Vibration level a_{hv} measured according to ISO 22867:
 - Control handle: 2.7 m/s².

- Left handle: 2.6 m/s².

FS 411 C-M

- Sound pressure level L_{pA} measured according to ISO 22868: 99 dB(A).
- Sound power level L_w measured according to ISO 22868: 109 dB(A)
- Vibration level a_{hv} measured according to ISO 22867:
 - Control handle: 2.4 m/s².
 - Left handle: 2.6 m/s².

FS 461 C-M

- Sound pressure level L_{pA} measured according to ISO 22868: 101 dB(A).
- Sound power level L_w measured according to ISO 22868: 110 dB(A)
- Vibration level a_{hv} measured according to ISO 22867:
 - Control handle: 2.3 m/s².
 - Left handle: 2.4 m/s².

For information on compliance with Employers' Vibration Directive 2002/44/EC see www.stihl.com/vib.

19.5 REACH

REACH is an EC regulation and stands for the Registration, Evaluation, Authorisation and Restriction of Chemical substances.

For information on compliance with the REACH regulation see www.stihl.com/reach.

19.6 Exhaust Emissions

The CO₂ value measured in the EU type approval procedure is specified at www.stihl.com/co2 in the product-specific technical data.

The measured CO₂ value was determined on a representative engine in accordance with a standardised test procedure under laboratory conditions and does not represent either an explicit or implied guarantee of the performance of a specific engine.

The applicable exhaust emission requirements are fulfilled by the intended usage and maintenance described in this instruction manual. The type approval expires if the engine is modified in any way.

20 Combinations of Cutting Attachments, Deflectors and Carrying Systems

20.1 Combinations of cutting attachments, deflectors and carrying systems

Cutting attachment	Deflector	Carrying System
<ul style="list-style-type: none"> – AutoCut 46-2 mowing head – DuroCut 40-4 mowing head – PolyCut 48-2 mowing head – SuperCut mowing head 40-2 – TrimCut C 42-2 mowing head 	<ul style="list-style-type: none"> – Guard for mowing heads 	<ul style="list-style-type: none"> – Full harness with quick-release system
<ul style="list-style-type: none"> – Grass cutting blade 230-4 (230 mm dia.) – 250-32 Grass cutting blade (250 mm dia.) – Grass cutting blade 250-40 "Special" (250 mm dia.) – Grass cutting blade 255-8 (255 mm dia.) 	<ul style="list-style-type: none"> – Deflector for metal cutting attachments 	
<ul style="list-style-type: none"> – Brush knife 300-3 (300 mm dia.) – Brush knife 305-2 "Special" (305 mm dia.) 	<ul style="list-style-type: none"> – Deflector for metal cutting attachments 	
<ul style="list-style-type: none"> – Shredder blade 270-2 (270 mm dia.) 	<ul style="list-style-type: none"> – Shredder blade deflector 	
<ul style="list-style-type: none"> – Circular saw blade 225-48 scratcher tooth (225 mm dia.) – 225-24 circular saw blade, chisel tooth (225 mm dia.) – HP chisel tooth 225-22 circular saw blade (225 mm dia.) – 225-36 circular saw blade, carbide (225 mm dia.) 	<ul style="list-style-type: none"> – Limit stop with diameter 225 mm 	
<ul style="list-style-type: none"> – Circular saw blade 250-26, chisel tooth (250 mm dia.) 	<ul style="list-style-type: none"> – Limit stop with 250 mm diameter 	

21 Spare Parts and Accessories

21.1 Spare parts and accessories

STIHL These symbols indicate original STIHL spare parts and original STIHL accessories.

STIHL recommends the use of original STIHL spare parts and accessories.

Despite ongoing market observation, STIHL is unable to judge the reliability, safety and suitability of other manufacturers' spare parts and accessories; accordingly, STIHL cannot warrant for the use of those parts.

Original STIHL spare parts and original STIHL accessories are available from STIHL dealers.

22 Disposal

22.1 Disposing of the Brushcutter

Contact the local authorities or your STIHL dealer for information on disposal.

Improper disposal can be harmful to health and pollute the environment.

- ▶ Take STIHL products including packaging to a suitable collection point for recycling in accordance with local regulations.
- ▶ Do not dispose with domestic waste.

23 EC Declaration of Conformity

23.1 STIHL FS 361 C-M, FS 411 C-M, FS 461 C-M Brushcutter

ANDREAS STIHL AG & Co. KG
Badstraße 115
D-71336 Waiblingen

Germany

declare under our sole responsibility that

- Category: Brushcutter
- Manufacturer's brand: STIHL
- Type: FS 361 C-M, FS 411 C-M, FS 461 C-M
- Serial number: 4147

conforms to the relevant provisions of Directives 2011/65/EU, 2006/42/EC, 2014/30/EU and 2000/14/EC and has been developed and manufactured in compliance with the following standards in the versions valid on the date of production: EN ISO 11806-1, EN 55012 and EN 61000-6-1.

The measured and guaranteed sound power levels were determined according to Directive 2000/14/EC, Annex V.

FS 361 C-M

- Measured sound power level: 112 dB(A)
- Guaranteed sound power level: 114 dB(A)

FS 411 C-M

- Measured sound power level: 112 dB(A)
- Guaranteed sound power level: 114 dB(A)

FS 461 C-M

- Measured sound power level: 113 dB(A)
- Guaranteed sound power level: 115 dB(A)

The technical documents are stored at ANDREAS STIHL AG & Co. KG Produktzulassung.

The year of manufacture, country of manufacture and serial number are specified on the rating plate of the brushcutter.

Waiblingen, 2022-08-01

ANDREAS STIHL AG & Co. KG

pp 

Robert Olma, Vice President, Regulatory Affairs
& Global Governmental Relations

www.stihl.com



0458-838-8301-A



0458-838-8301-A