

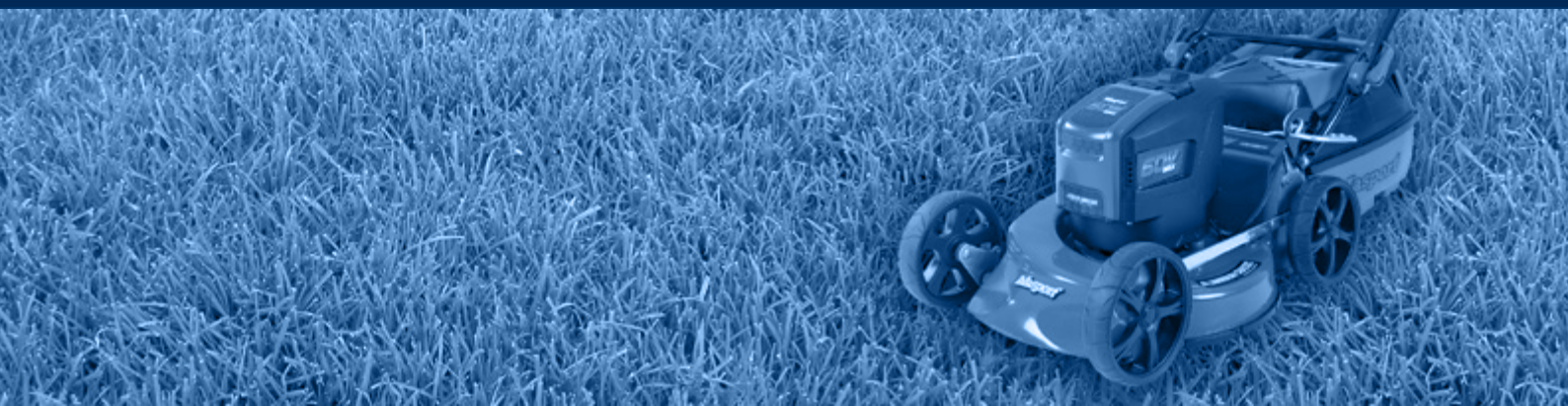

60V BATTERY POWERED ROTARY MOWER

Owner's Manual



Owner's Manual

Masport AeroCore Rotary Mower

Important

To reduce the risk of fire, burn hazard or other injury, please read these instructions carefully before use.

Keep these instructions in a safe place for future use.

This manual covers the Masport 60V Max AeroCore Battery Power-head











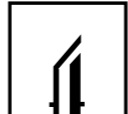

CONTENTS

EXPLANATION OF SYMBOLS	3
PRODUCT SPECIFICATION	4
SAFETY INSTRUCTIONS	4
TRAINING.....	5
PREPARATION.....	5
OPERATION.....	5
MAINTENANCE.....	5
STORING THE MOWER.....	5
FOLDING THE HANDLE.....	5
ASSEMBLING THE MOWER	5
FITTING THE HANDLE.....	5
ASSEMBLING THE 'SCREW LOCK' HANDLE.....	6
ASSEMBLING THE LOWER HANDLE.....	6
ASSEMBLING THE 'CAM LOCK' HANDLE.....	6
PREPARING THE POWER-HEAD	6
CHARGING THE BATTERY PACK.....	6
CHARGER INDICATOR.....	6
STARTING	7
STOPPING THE MOWER	8
DRIVE CONTROLS	8
THE GRASS CATCHER	9
CATCHER ASSEMBLY.....	9
FITTING THE CATCHER.....	9
FITTING THE FABRIC CATCHER.....	10
REMOVING THE GRASS CATCHER.....	10
EMPTYING.....	10
CATCHER LEVEL INDICATOR.....	10
GRASS CATCHER MAINTENANCE.....	10
CUT HEIGHT CONTROL	10
MOWING ACCESSORIES	10
MOWING ADVICE	10
MOWING ADVICE— 'SMART CHUTE'.....	10
FITTING THE MULCHING PLUG TO THE MOWER	11
AFTER MOWING	12
CLEANING.....	12

BLADES	12
BLADE SERVICING INSTRUCTIONS.....	12
BLADE REPLACEMENT TORQUE SETTINGS:.....	12
DRIVE MAINTENANCE	12
SINGLE SELF PROPELLED MODELS.....	12
GEARBOX.....	12
CLEANING MAINTENANCE	12
BELT ADJUSTMENT	12
SINGLE SPEED MODELS.....	12
TROUBLE SHOOTING	13
WARRANTY	14

EXPLANATION OF SYMBOLS

- | | | | | | | | | | |
|---|---|---|---|---|---|---|---|--|--|
| 1. | 2. | 3. | 4. | 5. | 6. | 7. | 8. | 9. | |
|  |  |  |  |  |  |  |  |  | |
| 10. | 11. | | | | | | | | |
|  |  | | | | | | | | |
| | | | | | <ol style="list-style-type: none"> 1. Read Owner's Manual 2. Keep bystander away. 3. Drive Clutch 4. Caution rotating blade— keep hands and feet clear. 5. Remove Safety key | | | <ol style="list-style-type: none"> 6. Slip on slope 7. Noise Limit 8. Wear ear protection 9. Wear eye protection 10. Wear protective gloves 11. WEEE Recycle | |

PRODUCT SPECIFICATION

1. PRODUCT DESCRIPTION

Aerocore uses lithium ion batteries with a maximum (MAX) rated output voltage of 60V and a charge storage capacity of 2.5 Ah and 5 Ah, respectively. As soon as the rechargeable battery is inserted into the charger, the charger automatically detects the charge status of the rechargeable battery. The charging process then begins. It ends automatically when the rechargeable battery is charged. The rechargeable battery can be charged in any charge status. Interrupting the charging process does not damage the rechargeable battery. Disclaimer: Maximum initial battery voltage (measured off load) is 60.0V. Nominal voltage as per industry rule (3.6V /cell) is 54 Volts.

2. DESIGNATED USE

The rechargeable battery is intended for Masport 60V Aerocore appliances that are operated by a rechargeable battery. It cannot be used in environments where there is a potential risk of explosion and/or fire. The rechargeable battery must only be charged with the Masport Aerocore battery charger.

Masport Aerocore 60V Battery Charger
Charger Product No. 553157

SAFETY INSTRUCTIONS

GENERAL SAFETY RULES

READ ALL INSTRUCTIONS CAREFULLY



WARNING!

- For safe operation, read and understand the instruction manual.
- To reduce the risk of electric shock, do not expose to water or operate on wet ground.
- Replace any damaged parts immediately. Remove the safety key prior to servicing.
- For use only with Masport 60V Aerocore batteries and charger.

BATTERY & CHARGER



DANGER!

Danger of explosions and fires!

- Persons can be fatally or severely injured if the rechargeable battery explodes because it was used in an environment where there is a potential risk of explosion and/or fire.
- Do not use the rechargeable battery in a potentially explosive environment.
- Do not throw the rechargeable battery into an open fire.



WARNING!

Danger of fires and electric shocks!

- Persons can be fatally or severely injured if the rechargeable battery causes a fire due to a short-circuit because it was exposed to moisture and humidity.
- Do not expose the rechargeable battery to moisture and humidity.



IMPORTANT!

Danger from water

Water in the appliance causes short-circuits and destroys electrical components.

- Do not spray the appliance with water.
- Only use a broom or a brush for cleaning.

BASIC SAFETY INSTRUCTIONS

This section mentions all basic safety and warning information to be heeded when using the charger. Read these instructions.

Always remove the safety key (twist to lock/unlock) from your Powerhead when you are assembling parts, making adjustments, cleaning, or when not in use. Removing the safety key will prevent accidental starting that could cause serious personal injury.

Always remove the safety key and refit the rubber socket cover before storing the device.

Only use the rechargeable battery as designated, i.e. for Masport rechargeable battery-driven devices. Charge the rechargeable battery only with the charger.

Only unpack the new rechargeable battery from the original packaging when it is to be used.

Fully charge the rechargeable battery before using it for the first time and always use the specified charger. Always comply with the details given in these instructions for use for charging the rechargeable battery.

Only use original rechargeable batteries and chargers from Masport.

Do not use the rechargeable battery in environments where there is a potential risk of explosion and/or fire.

Do not expose the rechargeable battery to moisture and humidity when in use on the appliance.

Protect the rechargeable battery from heat, oil and fire to prevent it being damaged so no vapours and electrolyte liquids can escape.

Do not subject the rechargeable battery to impacts or throw it.

Do not use the rechargeable battery when soiled or wet. Before use, clean and dry the rechargeable battery with a dry, clean cloth.

When battery pack is not in use, keep it away from other metal objects, like paperclips, coins, keys, nails, screws or other small metal objects that can make a connection from one terminal to another. Burns or fire can result from a short-circuit.

Do not open, dismantle or crush the rechargeable battery. There is a danger of electric shock and short-circuit.

Improperly use can damage the rechargeable battery which may cause vapours and/or electrolyte fluid to escape the enclosure casing. Vent the storage room adequately and in the case of any discomfort from the fume, consult a doctor.

In the event of contact with electrolyte fluid, flush with water and immediately rinse the eyes thoroughly. Then consult a doctor.

The rechargeable battery must not be used by unauthorised persons unless they are supervised by a person responsible for their safety or have been instructed on how to use the rechargeable battery.

by persons (including children) with limited physical, sensory or mental aptitude.

by persons who have no experience and/or knowledge of the appliance. Children must be supervised around the rechargeable battery, and must not play with the battery.

Do not leave the rechargeable battery permanently in the charger. For prolonged storage, remove the rechargeable battery from the charger. When not in use, remove the rechargeable batteries from the operated appliances.

Keep the unused rechargeable battery stored in a dry and cool place, away from direct sunlight.

The mower is to be supplied through a residual current device (RCD) having a rated residual operating current not exceeding 30mA.

Protect from heat and direct sunlight. Unauthorised persons and children must not have access to the rechargeable battery.

THIS MANUAL COVERS A RANGE OF DIFFERENT MASPORT MOWERS. SOME FEATURES MENTIONED MAY NOT APPLY TO YOUR MOWER.

IMPORTANT: Keep these instructions in a safe place for future reference. They contain important information about your mower.

Record the serial number, you may need this when ordering spare parts.

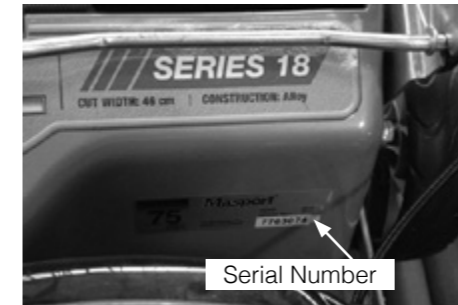

CAUTION

A CAUTION INDICATES SPECIAL PRECAUTIONS THAT MUST BE TAKEN TO AVOID DAMAGE TO THE MOWER.



WARNING

A WARNING INDICATES SPECIAL PROCEDURES THAT MUST BE FOLLOWED TO AVOID INJURY TO THE OPERATOR OR ANY BYSTANDER.

SAFETY INSTRUCTIONS



PLEASE READ ALL INSTRUCTIONS BEFORE ATTEMPTING TO USE YOUR MOWER.

TRAINING

1. Read the operating and maintenance manuals carefully. Be thoroughly familiar with the controls and the proper use of the equipment.
2. Know how to stop the mower and disengage the controls quickly in an emergency.
3. Never allow children or people unfamiliar with these instructions to operate the mower.
4. Keep the area of operation clear of all persons, particularly small children and pets.
5. Never mow while people, especially children, or pets are nearby.
6. Keep in mind that the operator or user is responsible for accidents or hazards occurring to other people or property.

PREPARATION

1. Thoroughly inspect the area where the equipment is to be used and remove all stones, sticks, wires, bones and other foreign objects before mowing, they could be thrown by the blade.

2. Do not operate the equipment when barefoot or wearing open sandals. Always wear substantial footwear and long trousers. It is advisable to wear suitable eye protection.
3. Never attempt to make a wheel height adjustment while the motor is running.
4. Mow only in daylight, and always keep children away from the mowing area.
5. Never operate the equipment in wet grass.
6. Always be sure of your footing; keep a firm hold on the handle and walk; never run. Never walk backwards while cutting grass.
7. Before using, always visually inspect to see that the blades, blade bolts, and cutter assembly are not worn or damaged. Replace worn or damaged blades and bolts in sets to preserve balance.
8. On multi-bladed appliances, take care as rotating one blade can cause other blades to rotate.

OPERATION

1. Disengage all blade and drive controls before starting the powerhead.
2. Do not tilt the mower when starting the powerhead.
3. Start the motor carefully with feet well away from the blades.
4. Do not put hands or feet near or under rotating parts. Always keep clear of the blade and discharge opening.
5. Stop the motor when crossing gravel drives, walks or roads.
6. Don't mow over heavy or solid objects as striking them with the blade can cause serious damage to the motor and will void your warranty.
7. After striking a foreign object, stop the motor, thoroughly inspect the mower for any damage, and repair the damage before restarting and operating the mower.
8. If the mower should start to vibrate abnormally, stop the motor and check immediately for the cause. Vibrations generally indicate there may be an issue.
9. Stop the motor whenever you leave the mower, even for a moment, before cleaning the mower housing, and when making any repairs or inspections.
10. When cleaning, repairing or inspecting, make certain the blade and all moving parts have stopped. Disconnect the safety key to prevent accidental starting.
11. Shut the motor off and wait until the blade comes to a complete stop before removing the grass catcher or unclogging the chute.
12. Mow across the face of slopes; never up and down. Exercise extreme caution when changing direction on slopes. Do not mow excessively steep slopes.
13. Never operate the mower without proper guards, deflectors provided by the manufacturer, or other safety devices in place.
14. Never pick up or carry a mower when it is operating.
15. Walk, never run.
16. Use extreme caution when reversing or pulling the mower toward you.
17. Stop the blades if the lawnmower has to be tilted for transportation when crossing surfaces other than grass, and when transporting the lawnmower to and from the area to be mowed.
18. Do not start the motor when standing in front of the discharge chute.
19. Mow only in daylight or in good artificial light.
20. Avoid operating the mower in wet grass, where feasible.
21. Remove the safety key from the powerhead socket: Whenever you leave the machine for extended period of time;

Before clearing a blockage; Before checking, cleaning or working on the mower; After striking a foreign object. Inspect the mower for damage and make repairs as necessary; If the mower starts to vibrate abnormally (check immediately)

MAINTENANCE

1. Before using, check the blade(s) and blade bolt(s) for wear and damage. Replace worn or damaged blades and bolts in sets to preserve the balance. DAMAGED BLADES AND WORN BOLTS ARE MAJOR HAZARDS.
2. Keep all nuts, bolts and screws tight to be sure the mower is in safe working condition.
3. After extended usage, allow the motor to cool before storing in any enclosure.
4. To reduce electrical hazard, keep the motor away from water or other liquids.
5. Check the catcher frequently for deterioration and wear, and replace worn catcher. Check that replacement catcher comply with the original manufacturer's recommendations or specifications.

STORING THE MOWER

The handle can be folded to minimise space requirements.

FOLDING THE HANDLE

Loosen the clamp knobs or unlock the handle lever(s) in the middle of the handle and fold the top section over the powerhead. Ergoshift models can also be stored by moving the handle to the upright position.



CAUTION

Check that the control cables are not being strained while folding and unfolding the handle. Permanent kinks will make the controls difficult to operate.

ASSEMBLING THE MOWER

Please refer to the following sections when preparing the mower for its first use.

- Fitting the handle
- Preparing the Power-head
- Assembling the catcher

NOTE - The left and right sides of the mower are referred to as viewed from the operating position behind the handle.

FITTING THE HANDLE

In some cases the handle may be completely detached from the mower body although the upper handle may be connected by the throttle control cable. Carefully remove the mower and handles from the box together to avoid damaging the throttle control.

ASSEMBLING THE 'SCREW LOCK' HANDLE.

The lower handle is fitted to the mower using the four bolts located in the handle brackets, two on each side, as indicated 'A' in the drawing below. To bolt the lower handle to the mower fit the bolts through the lower handle then fit the handle to the mower body and tighten the nuts on the outside of the mounting brackets using a 13mm A/F socket or spanner.

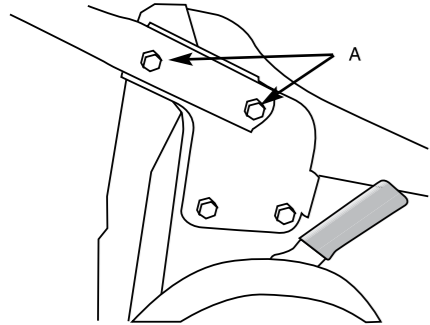

Now attach the upper handle to the lower handle.

420MM MODELS

The 420mm model is shipped with the handle completely detached from the mower body although the upper handle may be connected by the throttle control cable to the power-head. Carefully remove the mower and handles from the box together to avoid damaging the throttle control and cable.

ASSEMBLING THE LOWER HANDLE

The lower handle stubs are fitted to the mower using the four bolts located in the handle brackets, two on each side, 'B' in the drawing below. To bolt the lower handle to the mower fit the bolts through the lower handle then fit the handle to the mower body and tighten the nuts on the inside of the housing using a 13mm A/F socket or spanner.

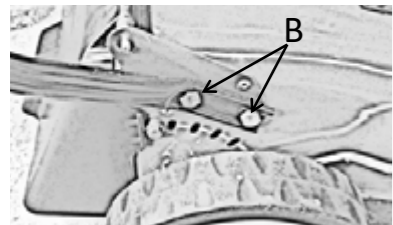

Now attach the upper handle to the lower handle stubs.



CAUTION

Take care not to rotate the handle before fitting it, as this will tangle the control cable(s).

Fit the two long bolts through the holes in the lower handle from the inside with the round heads snug against the tube. Fit the holes in the

upper handle over the two long bolts. Attach the plastic knob to the outside of the lower handle bolt as shown below and tighten by hand until the upper handle is locked in position.

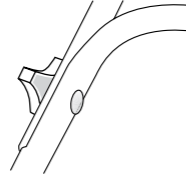

ASSEMBLING THE 'CAM LOCK' HANDLE.

Most of these models are fully assembled when packed, so all that is needed is to remove them from the carton, swing the handle to the operating position and lock the handle lever(s).

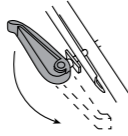

THE CAMLOCK HANDLES ON SOME MOWERS ARE REVERSED FOR SHIPPING.

To turn them around unwind the nut to the end of the thread with a 13mm A/F spanner/socket, pull the camlock handle outwards and rotate it 180°. Re-tighten the nut until the handle locks firmly in place and it does not change position when in use.

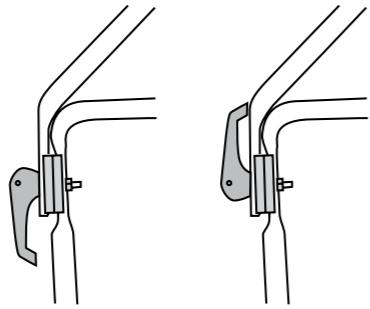

THE 'ERGO' HANDLE

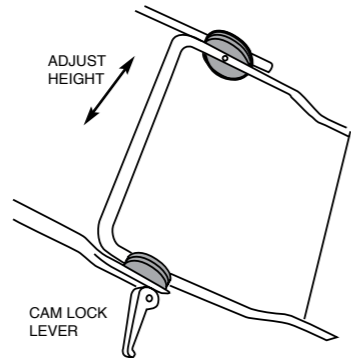

The 'Ergo' handle can be adjusted to your preferred height. Simply release both cam lock levers, move the upper handle to the height required and re-clamp the cam locks. Where the mower has screw type locks, wind the knobs firmly clockwise to lock the handle.

HANDLE LIFT SYSTEM

Some handles can be rotated forward to

give easy access to the rear flap. Depress the foot lever u and push the handle until you feel resistance— in a near vertical position v. The handle can be moved back to the mowing position without using the foot lever.

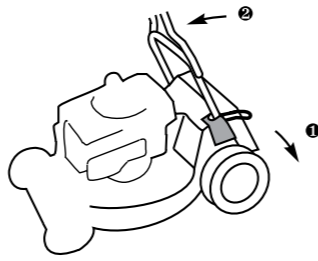

PREPARE THE POWER-HEAD

1. Charging the battery pack

IMPORTANT NOTES FOR CHARGING BATTERY
The battery is not charged fully when you receive it. Therefore it must be fully charged before using the first time.

NOTE: If the battery pack is very hot you must remove your battery pack from the charger and allow your battery pack to cool first to ambient temperature and then recharging can be started. To prevent damage to the Battery Pack, when charge runs out, please charge the battery to reach full or no less than half charge before storage. If the tool will not be used for long periods of time, fully charge the battery every 3-6 months.

CHARGING PROCEDURE

- 1) Plug the charger into an appropriate outlet. The light will be green.
- 2) Slide the battery pack into the charger, the light will turn to green and flash to indicate the charging process has started.
- 3) When charging is completed, the light will turn to green without flashing. The pack is now fully charged, unplug the charger and remove the battery pack.

WARNING:

When battery charge is exhausted following continual use or is exposed to direct sunlight or heat, allow time for the tool to cool down before re-charging to achieve the full charge.



CHARGING INDICATOR

This charger is designed to detect some problems that can arise with battery packs. Red indicator lights indicate problems (refer to following table). Insert a second battery pack into the charger, if one is available, to determine if the charger is ok. If the new battery charges

correctly, then the original pack is defective and should be returned to a service center or recycling service center. If the new battery pack displays the same problem as the original Battery Pack, have the charger tested at an authorised service center. If a second battery is not available, return to service agent for checking.

Light	On/Flash	Status
	Red On	Defective battery
	Red Flash	Battery Temperature Protection. The temperature of battery pack is less than 0° or more than 40°.
	Green On	Fully Charged.
	Green Flash	Charging.

2. Installing and removing the battery pack

1). Slide the battery pack into the mower's battery port. A simple push and slight pressure to click to the catch will be sufficient (see below).



2). To remove the battery, simply press the battery pack latch and remove the battery pack from the battery port. (See below)



STARTING

Ensure that the battery has been recharged and that the safety key is inserted correctly and in the ON position. We recommend that you check the battery level before every mowing session.

Press the start button and pull back the switch bail to start the power-head.

WARNING! THE BLADE CONTINUES TO ROTATE FOR A FEW SECONDS AFTER THE MACHINE IS SWITCHED OFF. ALLOW THE MOTOR/BLADE TO STOP ROTATING BEFORE SWITCHING "ON" AGAIN. DO NOT RAPIDLY SWITCH OFF AND ON.



WARNING
OPERATING THE STARTER ROTATES THE CUTTING BLADES - KEEP HANDS AND FEET WELL CLEAR.

HINTS FOR EASY STARTING

1. Stand the mower on a paved drive or path where the blade is clear of the grass and obstacles. If you must start on the lawn, move to an already cut area and/or raise the cutting height. Do not start the mower on a gravel surface.
2. Ensure no grass is caught on/obstructing blade before start the motor.
3. Keep the mower clean underneath.

TROUBLE SHOOTING CHECK LIST
Look for these faults:-

1. Insufficient power in battery.
2. Safety key is missing.
3. Safety key is not inserted correctly.
4. Safety key is not in ON position.
5. Battery not inserted correctly.

STOPPING THE MOWER

Release the switch lever to stop the mower.

DRIVE CONTROLS

This section is for Self-Propelled models only.

To engage the mower drive, simply push forward on the SP bail arm until it meets the handle grip. Releasing the bail will de-clutch the drive mechanism. Naturally you may use the mower as a push model by gripping the handle in the normal way.

SP DRIVE CLUTCH CABLE ADJUSTMENT

1. Confirm that the cable inner wire will move at least 26 mm when the SP bail is moved from the clutch disengaged (open- Fig1 and 2) position to the engaged (closed-Fig3) position against the handle. The first 13mm moves the lever of the gearbox(Fig4) to the engaged position and the final 13mm gives the spring the desired 140N for the required tension on the gearbox cones to work properly without slipping under load. Adjust the contour of the bail slightly if necessary to achieve this wire stroke as below.

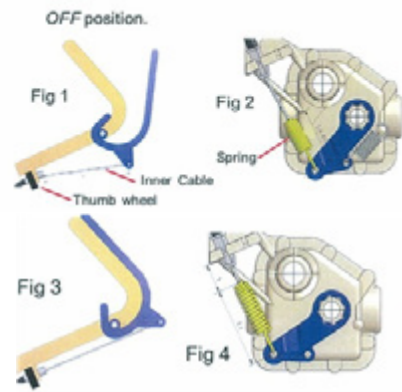

2. Wheel the mower back towards you while gradually closing the SP bail, and note the position of the bail when extra resistance to backward movement indicates that the drive clutch is just engaging. This extra resistance should occur when the SP bail is half way between open and closed (Fig 5).



Fig 5

Fig 6

3. If the engagement point is incorrect, adjust it by rotating the thumb-wheel on the anchor block at the top of the cable outer sleeve. Rotating the wheel clockwise will move the clutch engagement point nearer to the bail closed position, and anti-clockwise will move it toward the bail open position (Fig 6).

4. Confirm that the adjustment is correct by re-testing the engagement point.

5. Repeat this adjustment after 150 hours use of the mower or at any time if the mower drive seems to be slipping! **IMPORTANT:** An incorrectly adjusted clutch cable, or using the mower with the SP bail not fully against the handle will cause clutch slippage, belt damage, gearbox overheating and serious gearbox damage.



Adjust only to provide positive drive. Excess pressure will cause cable and belt stretch.

THE GRASS CATCHER

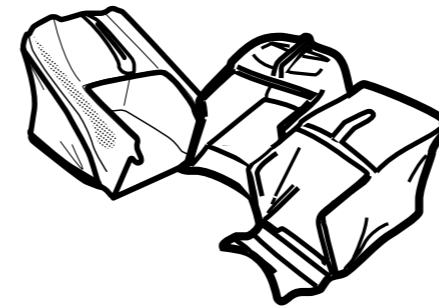
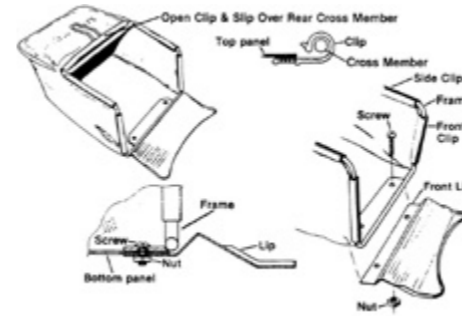

CATCHER ASSEMBLY

There are three catcher types:

- A. Bag Catcher
- B. Moulded Plastic Catcher
- C. Aero Catcher (moulded plastic top sections with fabric side panels.)

A. BAG CATCHER

1. Slide the bag over the wire frame. Fit the plastic clip up under the frame crossmember (the one which is formed into a handle) and hook the clip onto the wire crossmember. You may need a lever such as a screwdriver to open one end of the clip to get it started over the wire. Pass the side and front clips inside the frame and hook them onto the wire in a similar way.

2. Fasten the metal front lip to the catcher assembly by bolting it to the plate on the bottom of the frame. The bottom panel of the catcher should be fitted between the plate and the lip as shown. Fit the screws from the top with the nuts under the lip, and tighten them securely.

B. MOULDED PLASTIC CATCHER

There are two types. One has the top cover and handle already fitted to the top shell of the catcher, while the other requires these parts to be assembled.

IF YOUR CATCHER HAS THESE PARTS ALREADY ASSEMBLED, START AT STEP 4

1. Place the top of the catcher shell (A) on a firm level surface with its mesh upwards.

2. Holding the top cover (B) with its concave side facing the mesh, lift its rear end and engage the front clips with the hooks on the catcher top shell. Keeping them engaged, swing the rear of the cover downwards and press it down until the barbs on the cover engage with the slots in the shell.

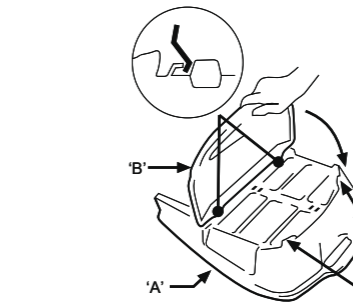

3. Look for the "F" on the handle and ensure that it will be adjacent to the "F" on the catcher shell. Fit the handle by pressing it firmly into the square recesses in the catcher top.

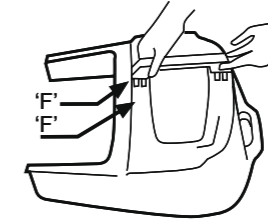

Turn the assembly over to confirm that the barbs on the handle are fully home, and push the tabs on the shell back into position to retain the handle.

4. Place the top shell on a solid work bench, open side up. Don't use a table which may be damaged by scratching.

5. Position the bottom shell, upside down,

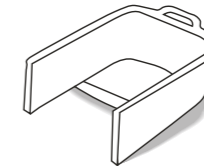

over the top shell, carefully aligning the two parts and ensuring the barbed clips are aligned with their corresponding slots and squeeze the rear handles together.

6. Keeping the catcher upside down, move the assembly so the lip and rear handle is supported by the edge of the bench (see diagram) and catcher is trapped between your body and the bench.

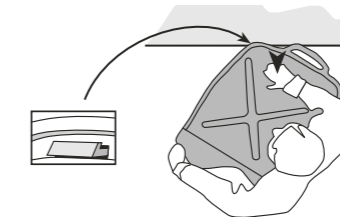

7. Strike the top of the assembly with an open hand above the part supported by the bench. You should hear the barb click into place in its slot - if not, check the alignment and strike again with a little more force.

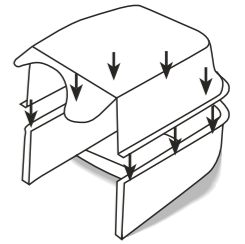

8. Working from left to right, and starting by the rear handle, move around the catcher, supporting each fastener in turn on the edge of the bench, as it is pushed into engagement.

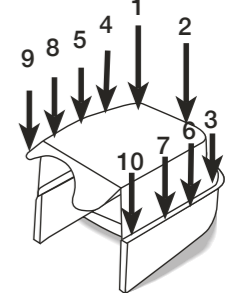

9. Finally inspect carefully to ensure that all clips are fully engaged.

FITTING THE CATCHER



THE CATCHER SHOULD BE FITTED TO AND REMOVED FROM THE MOWER ONLY WHEN THE MOTOR HAS STOPPED.

Standing to the right of the mower, reach down with your right hand and pull back and up on the handle of the safety flap or Smart Chute and lift it until it is parallel with the handle. Pick up the catcher with your left hand and swing it into position at the rear of the mower.

The catcher lip of the fabric and plastic catchers fits on top of the crossbar or the base of the tunnel, while the two hooks at the top of the Aero catcher mouth sit on top of the brackets inside the discharge outlet of the mower.

Once the catcher is positioned correctly, lower the flap or Smart Chute to hold it in place. Make sure that the rear edge of the flap or Smart Chute is fully engaged on the lip or bar at the rear of the catcher mouth.

420MM MODELS

FITTING THE PLASTIC CATCHER

Standing to the right of the mower, reach down with your right hand and pull back and up on the handle of the rear flap and lift it until it is parallel with the handle. Pick up the catcher with your left hand and swing it into position at the rear of the mower.

The catcher lip has two pins that need to be lined up with the slots of the housing.

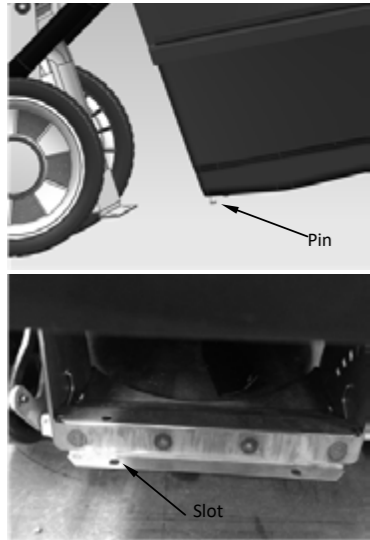

Once the catcher is positioned correctly, lower the flap to hold it in place. Make sure that the rear edge of the flap is fully engaged on the lip at the rear of catcher mouth.

FITTING THE FABRIC CATCHER

Standing to the right of the mower, reach down with your right hand and pull back and up on the handle of the rear flap and lift it until it is parallel with the handle. Pick up the catcher with your left hand and swing it into position at the rear of the mower.

The fabric catcher has two lugs which fit on the hooks near the handle brackets of the mower.

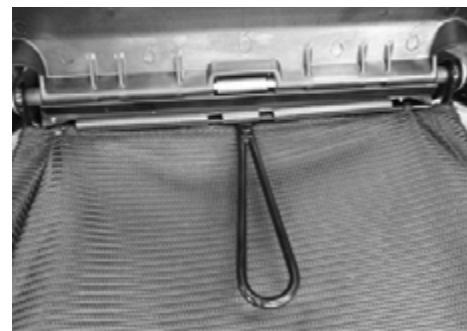

Once the catcher is positioned correctly, lower the flap.

REMOVING THE GRASS CATCHER

REMOVING THE GRASS CATCHER



ALL MODELS

Stop the motor and stand to the right of the mower. Grasp the catcher handle with the left hand and lift slightly while raising the safety flap or smart chute with the right hand. Lift the catcher clear and lower the flap or Smart Chute to cover the grass discharge outlet.

EMPTYING

Dump the grass from the catcher by holding it vertical, using the rear handle of the moulded catcher or holding the rear end of the steel frame of the fabric catcher. Shake if necessary to dislodge a full load.

CATCHER LEVEL INDICATOR

Some grass catcher models have a catcher Level Indicator to show how much grass has been collected. The indicator functions only when the motor is running at grass cutting speed. When the catcher is empty, the indicator will show all green, as the grass progressively fills the catcher, a red indicator zone will appear and increase in size. Attempting to over-fill the catcher will result in discharge chute blockage or a "dribble" of grass from the front of the catcher.

Experience in your particular grass and cutting conditions will soon show the size of the red indicator area corresponding to the ideal catcher emptying point. Hose the catcher thoroughly after each use to keep the indicator movement free.

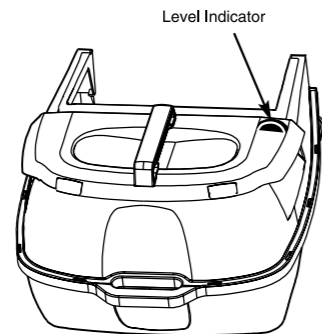

GRASS CATCHER MAINTENANCE

FABRIC TYPES.

These depend on a free flow of air through the fabric for effective grass collection. Wash as needed to restore and open mesh in the fabric. Do not leave a fabric bag in direct sunlight when not in use. While the bag will not rot if stored wet, prolonged sunlight exposure can cause premature breakdown of the material. Do not leave clippings in the catcher for extended periods.

WARNING

CHECK THE CATCHER BAG FREQUENTLY FOR DETERIORATION AND WEAR, AND REPLACE IF WORN. Use only genuine original equipment replacement catcher bags as others could be dangerous.

MOULDED PLASTIC TYPE.

These also need a free passage of air for efficient catching. Keep the air outlet mesh clear by hosing it frequently. Do not leave clippings in the catcher.

CUT HEIGHT CONTROL

The single point cut height control adjusts all four wheels simultaneously. To operate, steady the mower by grasping the handle with one hand, pull the lever outwards from the mower with the other hand, and move it to the desired setting.

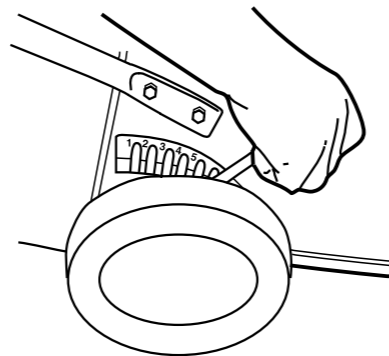

MOWING ACCESSORIES

A grass deflector chute for mowing without a catcher is available for some models from your dealer. Not required for 'Smart Chute' models.

MOWING ADVICE

The best time to mow your lawn is the early afternoon. By this time the grass has had a chance to dry out. Also the sensitive newly cut grass area isn't exposed to the direct sun.

For healthy growth, grass should not be cut too short. Using the lowest settings can result in destruction of the crown of grass, allowing flat lying weeds to develop.

Vary your cutting pattern from week to week. One week mow your lawn from north to south, the next week, mow your lawn from east to west. This will help prevent matting and graining of the grass.

For best performance, always keep the mowers blade sharp. A dull blade tends to tear, not cut, the blades of grass. When cutting very long grass, a preliminary cut on a high setting,

followed by a lower cut (preferably a day or so later), will minimise the overall time required for the job.

Do not try to cut too much off the grass at one time. This can cause excessive loads to be put on the engine and also effect the mulching performance.

Avoid using the lowest two or three height settings when mulching. For best results when mulching; cut off only the top third (or less) of the grass. Cutting lower than this will have a detrimental effect on the mulching performance.

AVOID USING THE LOWEST TWO OR THREE CUT-SETTINGS IN WET OR VERY LONG GRASS

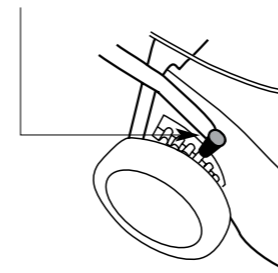

As you turn the mower at the end of a strip you may notice unmulched grass. The mower deck is naturally tilted upward when turning so that the air flow which holds the grass in position for recutting is momentarily decreased. After mowing the lawn, you can go back and mow only the turns so that the clippings are no longer visible.

Clean the mowing chamber frequently to remove grass build-up. This will keep mowing performance at its best, especially when mulching. Avoid cutting your lawn when it is wet. Wet grass tends to form clumps and interferes with the mulching action of the mower.

If you are not collecting the cut grass, mow in a pattern that deposits the clippings on the previously cut swathe. So, if your mower discharges clippings on the left, the next cut should be to the right of the previous one, and vice-versa.

If you use the mower often without collecting the clippings, you will find that the accessory grass delivery chute (available from your Dealer for most models) will assist by spreading the clippings more effectively.

WARNING

DISCHARGE OPENINGS MUST BE GUARDED AT ALL TIMES. DO NOT REMOVE THE GRASS DEFLECTOR OR HOLD THE SAFETY FLAP UP WHILE MOWING.

When cutting close to obstructions such as tree trunks, and when mowing to the edge of a lawn where there is no wheel support, use the left side of the mower, giving a useful blade 'overhang' for ready access to awkward areas.

MOWING ADVICE—'SMART CHUTE'

The 'Smart Chute' allows you to mow without catching the grass or mulching. By simply opening the 'door' located on the bottom left hand corner of the 'Smart Chute', the lawn can safely be mown while smoothly spreading the clippings to the left. For wet, heavy or very long grass we advise not using the lowest two of three cutting heights as this may cause clogging. If it still persists, try walking slower, cutting a narrower strip or raising the cut height more.

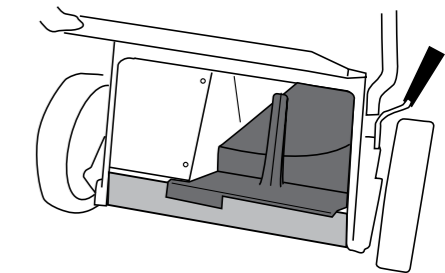
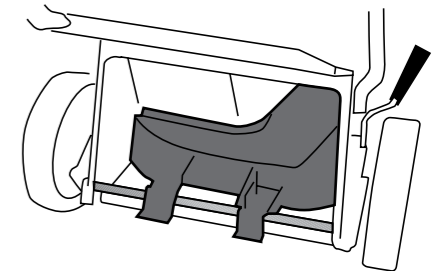
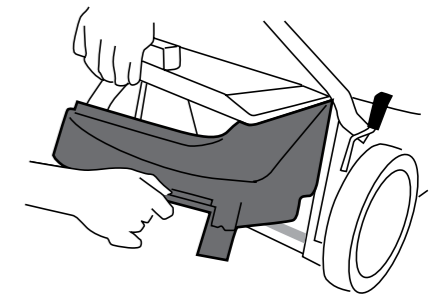
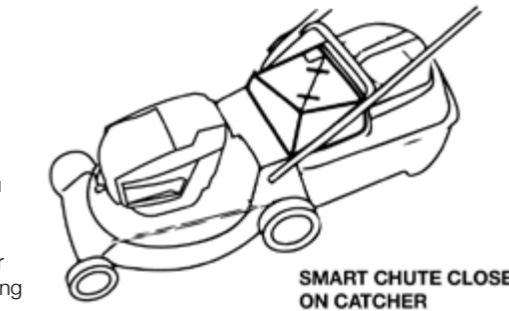
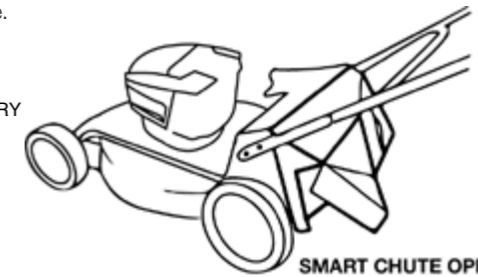

420MM MODELS

Raise the flap, and using the hand hold on the mulching plug, insert the mulching block, the angled section to the mowers right, into the discharge chute.

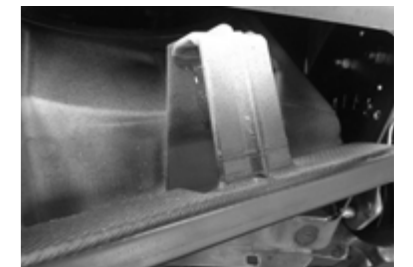

When fitting the plug into a mower, ensure that the pin at the left side of its base is into the notch of the housing before lowering the flap.

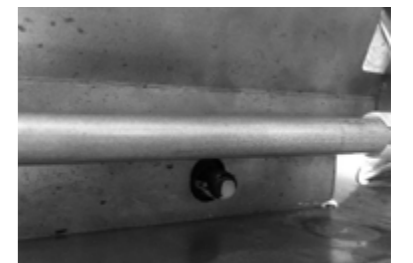

WARNING

Never use the 'Smart Chute' on the catcher with its door open. This could cause damage or injury to property or bystanders.

FITTING THE MULCHING PLUG TO THE MOWER

1. Stop the motor
2. Make sure the discharge chute and the underside of the mower are clean. See AFTER MOWING.
3. Lift the flap with one hand, and hold the mulch plug with the other hand. Insert the mulching plug, the angled section to the mowers right, into the discharge chute.

In the case of "open-back" mowers, make sure that the back of the block is sitting on the rear axle before lowering the flap. When fitting the block into a mower with a grass discharge chute, ensure that the lug at the left side of its base is slipped into the notch at the bottom rear of the chute sidewall before lowering the flap. See 'Mowing Advice' for mulching tips.

AFTER MOWING

CLEANING

Stop the motor, when the blade has stopped, disconnect the safety key. Use a dry brush/towel to clean the mower.

DO NOT WASH THE MOWER WITH WATER.

BLADES

DAMAGED BLADES AND WORN BOLTS ARE MAJOR HAZARDS.

Check the blade mounting bolts at frequent intervals for proper tightness.

Check the blade condition frequently, particularly if the mower has hit a foreign object or is vibrating. Sub-standard cutting and catching will result from a neglected blade. Your Authorised Dealer will be happy to sharpen or replace blades as necessary.

Battery mowers use a different blade design to that of petrol engine lawnmowers. Ensure the correct blades are used to maintain cutting and runtime performance.



CAUTION

ALWAYS USE GENUINE ORIGINAL EQUIPMENT PARTS TO ENSURE SAFETY AND PROPER PERFORMANCE. Substitute parts can be disappointing and dangerous.

BLADE SERVICING INSTRUCTIONS

TWO BLADES FLAT DISC.

1. Remove the safety key.
2. The cutting tips can be removed and replaced by removing the flat disc from the mower. Note the component positions when dismantling. When refitting the flat disc ensure the slots fit properly over the lugs and the drive plate, and replace the mounting bolts if they show signs of wear.

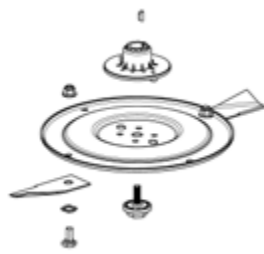

BLADE REPLACEMENT TORQUE SETTINGS:

Blade center bolt	38-42 Nm (28-31 ft.lb)
Tip mounting bolt	20-25 Nm (15-18 ft.lb)

DRIVE MAINTENANCE

SELF PROPELLED MODELS.

Every 100 hours -

Remove each rear wheel by removing the hub cap, and undoing the 8mm nyloc nut and washer retaining the wheel to the axle. Remove the circlip retaining the pinion, taking care not to over stretch it, and remove the washer and pinion. Apply grease to pawls (5), pinion bores (6), and wheel gears (7). Take care to replace the pawls exactly as they were removed, and do not move pinions to the opposite side of the mower.

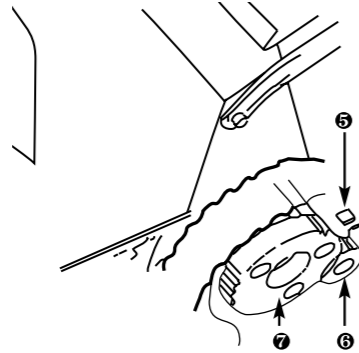

GEARBOX.

The gearbox on these models is a sealed unit that requires no maintenance. Just keep the outside clean.

CLEANING MAINTENANCE

THE FOLLOWING MAINTENANCE IS REQUIRED EVERY 100 HOURS OR WEEKLY IF USED COMMERCIALY (REFERS ONLY TO SELF-PROPELLED MOWERS)

Remove both the gearbox and drive belt covers. Clean out any debris within the drive belt cavity and around the gearbox using a dry brush/towel. Ensure that there is no grass build up between the gearbox clutch arm and travel stop.

BELT ADJUSTMENT

SINGLE SPEED MODELS.

Remove the safety key, tilt the mower to gain access to the gearbox. Using two 10mm AF spanners, slacken the screw which clamps the gearbox anchor bracket to the mower housing just enough to allow the gearbox to be rotated about its output shaft. Rotate the gearbox to take any slack out of the V belt drive and re-clamp the anchor bracket in its new position by tightening the clamp and screw firmly.

Keeping the end fittings stationary, rotate the barrel to push the ends apart to increase travel speed, and to bring the end fittings together to reduce travel speed. Using this adjuster will compensate for belt stretch or wear which may occur.

BELT ADJUSTMENT

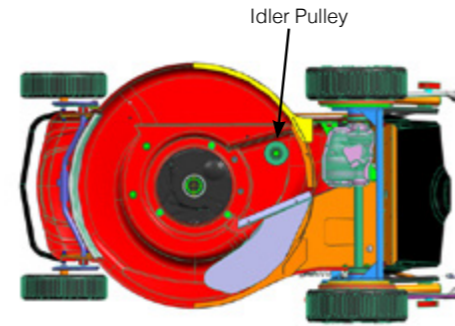

If the belt is to be replaced or worn and slipping and requires adjustment. Follow the servicing instructions for removing the "Blades" as explained in the Owner's manual. Remove the blade driver and belt covers.

Using two spanners to loosen the nut and bolt holding the idler pulley, while pressing it to tension the belt tighten the nut and bolt.

TROUBLESHOOTING

The electronic speed controller within the Masport AeroCore lawn mower has been designed to prevent potential damage by working within a safe operating zone. If the unit operates on particularly long / dense grass (first cut of the season for example) it can cause the controller to heat up. If the temperature is too high the controller will switch off the motor to protect from overheating. The motor will be able to operate again after it has cooled down.

The same is true of a separate electronic controller built into the Lithium Ion Battery pack and coupled with another one built into the smart charger. They have been designed to work in unison to protect the high performance Lithium Ion Battery, resulting in a long trouble free operating life and providing the optimum charge every time. In achieving this, the controller may sometimes prevent the battery from being charged if the previous run resulted in an overly warm battery pack. Waiting a brief period after cutting the grass before putting the machine on charge will allow the battery pack to cool down to enable it to receive a full fresh charge. This technology has been incorporated to protect the various items from damage and provide the user with a reliable long term product.

To allow the free running of the motor, do not cut with an excessively low cut height. Two light cuts are better than one heavy cut especially when not using the catcher and mulching.

Problem	Displays	Possible Cause	Solution
The power-head does not start.		Battery not charged.	Charge the battery.
		Safety key is not inserted correctly.	Insert safety key and twist to lock.
		Battery may require service.	Contact Masport approved dealership.
		Fuse is blown.	Replace fuse.
		Warm controller after cutting particularly long /dense grass.	Wait for controller to cool down.
		Not enough travel on the switch cable.	Make sure "Z" bend of the switch cable is located in the 3rd hole.
Excessive noise and/or vibration.		Bent motor shaft.	Remove safety key & inspect power-head for damage.
		Blade assembly is unbalanced.	Remove safety key & replace / repair blades and tighten bolt.
The rechargeable battery is not charging.	LED on the charging unit lights permanently red.	The service life of the rechargeable battery has expired.	Replace the rechargeable battery. Only use original accessories from Masport.
		The rechargeable battery is not fully inserted in the charger.	Fully insert the rechargeable battery in the charger.
	The LED on the charger flashes red	The plug contacts of the rechargeable battery or charger are soiled.	Disconnect the power plug and clean the plug contacts with a dry cloth. If the fault reoccurs, contact a Masport service centre.
		The rechargeable battery or charger is faulty.	Replace the rechargeable battery. Only use original accessories from Masport.
The LED on the charger is not active.	No mains voltage.	Insert the power plug or check that mains voltage is present.	
The rechargeable battery has been removed from the charger and is not charged.	On the rechargeable battery the red LED lights after pressing the push-button.	There is a fault on the rechargeable battery or on the charger (see above causes).	See above measures.
Beeps from the controller x 2		Low battery.	Charge the battery.
Beeps from the controller x 3		High temperature.	Wait for controller to cool down.

Beeps from the controller x 4		Excess current.	Remove safety key and inspect if the blade is jammed up with grass. Clear grass away. If that does not solve the problem, contact Masport approved dealership.
Beeps from the controller x 5		Motor Jam.	Remove safety key and inspect if the blade is jammed up with grass. Clear grass away.
Uneven/ poor cut		Blunt or damaged blade/s.	Sharpen, balance and or replace blade/s.
Heavy mulch left on cut strip		Cutting height is too low for the height of the grass being cut.	Adjust the cutting height to approximately one third of the length of the grass. Then work down to the desired height.
		Underside of the mower's deck is clogged with wet grass clippings.	Clean off the underside of the mower using dry brush/towel.

WARRANTY

Check warranty card for terms.