



OPERATION MANUAL

GFORCE

**GARDEN
PRODUCTS
LAWN
MOWER**

GZ132

GZ149

GZ-X196



WARNING!

Read this manual carefully before using your lawn mower and keep it in a safe place for future reference.



DESCRIPTION OF PRODUCT PARTS	4
TECHNICAL SPECIFICATIONS	6
INTENDED USE	6
SAFETY INFORMATION	7
ASSEMBLY	10
PREPARING THE ENGINE	12
ADJUSTMENT	14
OPERATION	14
MAINTENANCE AND STORAGE	16
TROUBLESHOOTING	19
WARRANTY	20

DESCRIPTION OF PRODUCT PARTS

As shown below

- | | |
|-------------------|--------------------------------------|
| 1. Throttle lever | 10. Rear wheel |
| 2. Upper handle | 11. Oil filler cap and dipstick |
| 3. Fast clip | 12. Central height adjustment handle |
| 4. Cable clip | 13. Fixing knob |
| 5. Lower handle | 14. Engine starter handle |
| 6. Fuel cap | 15. Grass catcher |
| 7. Air filter | 16. Rear flap |
| 8. Deck | 17. Grass catcher handle |
| 9. Front wheel | 18. Rope guide |

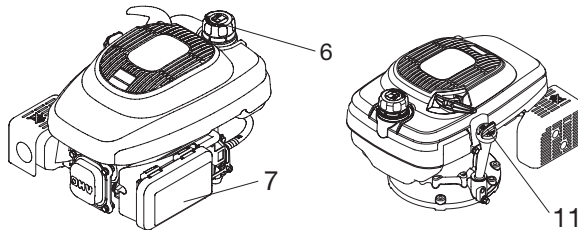
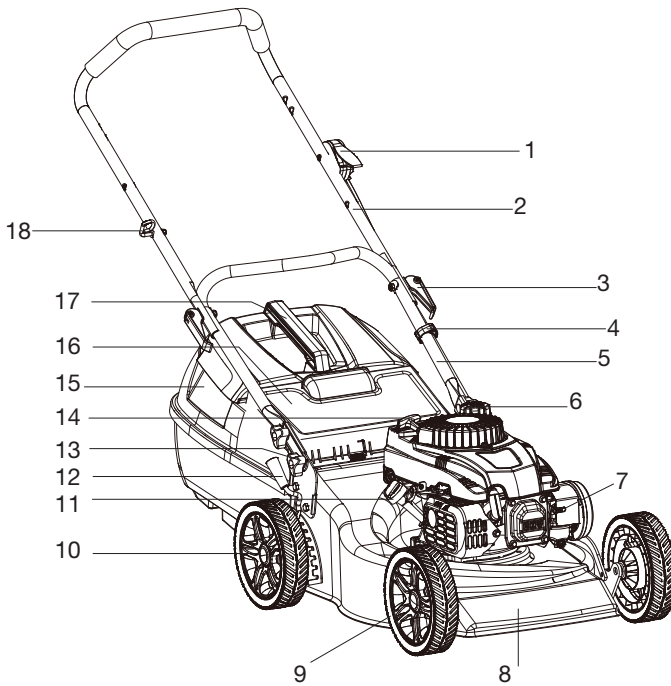

(GZ-X196 engine, XP200)

Check the delivery parts

As shown below

Carefully remove the lawn mower from its packaging and check as the following parts are complete:

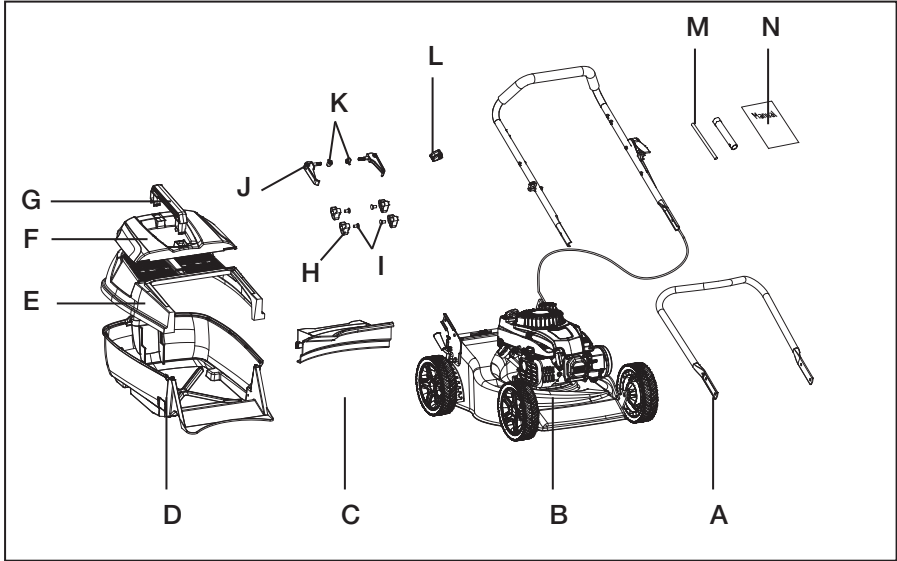

- A. Lower handle
- B. Main unit with upper handle
- C. Mulching plug
- D. Lower grass catcher
- E. Upper grass catcher
- F. Grass catcher cover
- G. Grass catcher handle
- H. Fixing knobs x4
- I. Bolts x4
- J. Fast clips x2
- K. Nuts x2
- L. Cable clip
- M. Spark plug spanner
- N. Manual



WARNING: If any parts are damaged or missing, please contact your dealer. Do not operate this mower until the parts are replaced.

















TECHNICAL SPECIFICATIONS

Model	GZ132	GZ149	GZ-X196
Engine model	NP130	NP150	XP200
Engine displacement	132 cc	149 cc	196 cc
Cutting width	460 mm	460 mm	460 mm
Cutting blade	Oval disc + 2 blades	Round disc + 4 blades	Round disc + 4 blades
Cutting height	15-80 mm	15-80 mm	15-80 mm
Wheel diameter	200 mm	200 mm	200 mm
Grass catcher volume	50 litres	50 litres	50 litres
Spark plug model	F6RTC	F6RTC	F6RTC

INTENDED USE

The petrol lawnmower is for cutting grass on lawns. It is for outdoor use only. It is designed for domestic use and is not designed for commercial, trade or industrial use.

SAFETY INFORMATION

 	<p>WARNING!</p> <p>To reduce the risk of injury, user must read and understand the instruction manual before using the mower</p>
 	<p>WARNING! Beware of thrown objects</p> <p>Keep bystanders away</p>
 	<p>WARNING! Keep hands and feet away from the blades</p> <p>Unplug the spark plug before maintenance</p>
 	<p>Risk of fire</p> <p>Never refuel while the engine is running</p>
 	<p>WARNING! Hot surface</p> <p>Do not open or remove the safety shields while the engine is running</p>
 	<p>Check the engine oil level and fuel before operation</p> <p>Wear eye and ear protection when using the mower</p>
 	<p>WARNING! The mower's exhaust gas contains toxic substances</p> <p>Do not run the engine indoor.</p>
	<p>Throttle positions - STOP, SLOW and FAST</p>
	<p>Sound power level noise label</p>
	<p>Australian Regulatory Compliance Mark</p>

GENERAL SAFETY WARNINGS

Training

1. Read the instructions carefully. Be familiar with the controls and the proper use of the mower;
2. Never allow children or people unfamiliar with these instructions to use the mower. Local regulations can restrict the age of the operator;
3. Never mow while people, especially children or pets are nearby;
4. Keep in mind that the operator or user is responsible for accidents or hazards occurring to other people or their property.

Preparation

1. While mowing, always wear safety footwear and long trousers. Do not operate the mower when barefoot or wearing open sandals; The use of safety glasses and hearing protection is also recommended.
2. Thoroughly inspect the area where the mower is to be used and remove all objects which can be thrown by the mower;
3. Warning - petrol is highly flammable.
 - Store fuel in containers specifically designed for this purpose;
 - Refuel outdoors only and do not smoke while refueling;
 - Add fuel before starting the engine. Never remove the cap of the fuel tank or add petrol while the engine is running or when the engine is hot;
 - If petrol is spilled, do not attempt to start the engine but move the mower away from the area of spillage and avoid creating any source of ignition until petrol vapors have dissipated;
 - Replace the fuel tank cap and fuel container cap securely;
4. Before using, always visually inspect to see that the blades, blade bolts and cutter assembly are not worn or damaged. Replace worn or damaged blades and bolts in sets to preserve balance;

Operation

1. Do not operate the engine in a confined space where dangerous carbon monoxide fumes can collect;
2. Mow only in daylight or in good artificial light;
3. Avoid operating the mower in wet grass, where possible;
4. Always be sure of your footing on slopes;
5. Walk, never run;
6. For wheeled rotary mowers, mow across the face of slopes, never up and down;
7. Exercise extreme caution when changing direction on slopes;
8. Do not mow excessively steep slopes;
9. Use extreme caution when reversing or pulling the mower towards you;
10. Stop the blade(s) if the mower has to be tilted for transportation when crossing surfaces other than grass, and when transporting the mower to and from the area to be mowed;
11. Never operate the mower with defective guards, or without safety devices, for

- example deflectors and/or grass catchers;
12. Do not change the engine governor settings or over speed the engine;
 13. Disengage all blades and drive clutches before starting the engine;
 14. Start the engine or switch on the motor carefully according to instructions and with feet well away from the blade(s);
 15. Do not tilt the mower when starting the engine or switching on the motor, except if the mower has to be tilted for starting. In this case, do not tilt it more than absolutely necessary and lift only the part which is away from the operator;
 16. Do not start the engine when standing in front of the discharge chute;
 17. Do not put hands or feet near or under rotating parts. Keep clear of the discharge opening at all times;
 18. Never pick up or carry a mower while the engine is running;
 19. Stop the engine and disconnect the spark plug lead, make sure that all moving parts have come to a complete stop:
 - Whenever you leave the mower;
 - Before refueling;
 - Before clearing blockages or unclogging chute;
 - Before checking, cleaning or working on the mower;
 - After striking a foreign object, inspect the mower for damage and make repairs before restarting and operating the mower;
 - If mower starts to vibrate abnormally (check immediately);
 20. Reduce the throttle setting during engine shut down and, if the engine is provided with a shut-off valve, turn the fuel off after finish mowing;

Maintenance and storage

1. Keep all nuts, bolts and screws tight to be sure the mower is in safe working condition;
2. Never store the mower with petrol in the tank inside a building where fumes can reach an open flame or spark;
3. Allow the engine to cool before storing it in any enclosure;
4. To reduce the fire hazard, keep the engine and petrol storage area free of grass, leaves, or excessive grease;
5. Check the grass catcher frequently for wear or deterioration;
6. Replace worn or damaged parts for safety;
7. If the fuel tank has to be drained, this should be done outdoors.

ASSEMBLY

Assembling the handle

Attached the lower handle to the bracket with Fixing knobs and nuts (x4) provided.

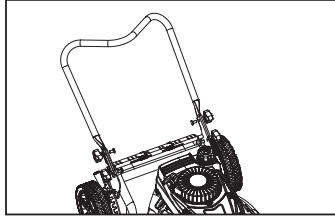

Attaching the upper handle

Attach the upper handle to the lower handle using the fast clips and bolts (x2) provided.

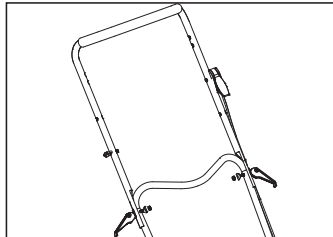

Fix the cable throttle control cable to the handle with the cable clip.

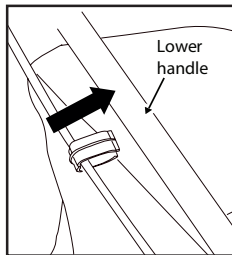

Assembling the grass catcher

1. Press the grass catcher handle firmly into the square recesses on the grass catcher cover.
2. Put the grass cover on the upper grass catcher. Aligning the lugs and slots and firmly press the grass cover onto the upper grass catcher.
3. Put the upper grass catcher on top of the lower grass catcher. Aligning the lugs and slots, press them together until they are clicked into place securely.

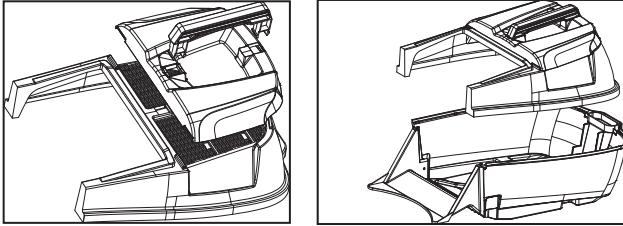

Attaching the grass catcher onto the mower

1. Lift the rear flap
2. Put the grass catcher to the mower, hold the grass catcher and put down the rear flap on the grass catcher.

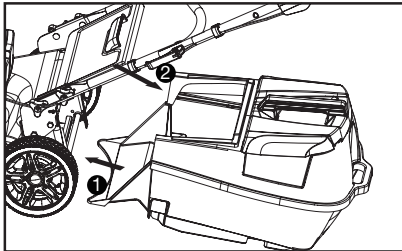

Attaching the mulching plug



Warning! Stop the engine before inserting or removing the mulching plug

1. Mulching is most effective if the mower's height setting is 4-10 (1 for lowest level and 10 for height level).
2. Make sure the engine and the blade are stopped before inserting the mulching plug.
3. Lift the rear flap and insert the mulching plug onto the baseplate.
4. Press the mulching plug down so that it is rested on the support plate and its lugs are securely fixed on the rear cross member.
5. Put down the rear flap and make sure that it is fully closed.

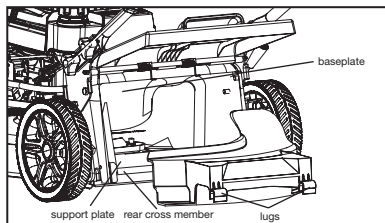

PREPARING THE ENGINE

Checking engine oil level and filling engine oil



WARNING! Fill up the mower with 0.4L (0.6L for GZ-X196) 4-Stroke engine oil before starting the engine for the first time.



WARNING! Check engine oil level before starting the engine.

1. Place the mower on a flat and level surface.
2. Clean the area around the oil filler cap.
3. Remove the oil filler cap and dipstick by rotating it anti-clockwise.
4. Wipe the dipstick clean.
5. For a new engine, add 0.4L (0.6L for GZ-X196) 4-Stroke engine oil.
6. Insert the dipstick back.
7. Remove the dipstick and check the oil level shown on the dipstick. Engine oil level should reach the upper (max.) limit mark on the dipstick.
8. If the engine oil level is low, add engine oil slowly into the engine.
9. After adding engine oil, wait for one minute and then check the engine oil level again.
10. After checking, replace and tighten the oil filler cap and dipstick.
11. Make sure that the oil filler cap and dipstick is securely tightened before starting the engine.

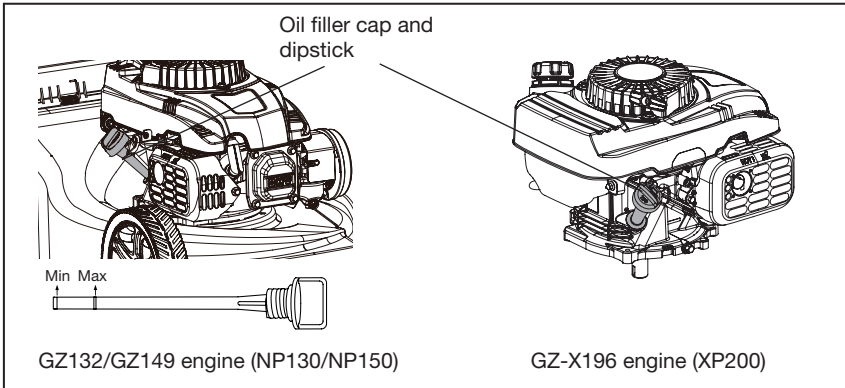

Filling engine fuel (petrol)



WARNING! Use fresh unleaded fuel (petrol), 90 Octane or better. Do not use E10 or Ethanol blends.



WARNING! Do not mix fuel (petrol) with engine oil.



WARNING! Do not overfill the fuel tank.



WARNING! Fuel (petrol) is highly inflammable. Handle the fuel (petrol) with extreme precaution. Keep the fuel (petrol) out of reach of children.



WARNING! Do not smoke when handling the fuel (petrol).



WARNING! Do not smoke or allow flame/sparks in the area where the engine is refueled or where the fuel (petrol) is stored.



WARNING! Refuel the engine in a well-ventilated area. If the engine has been running, allow it to cool down before refuelling.

Avoid prolonged contact with skin or inhalation of the fuel (petrol) vapour.

1. Clean the area around the fuel tank and check the fuel level.
2. Refill the fuel tank if the fuel level is low.
3. Refuel carefully to avoid overfill or spill of fuel (petrol).
4. Clean up any overflow or splashes of fuel (petrol) before starting the engine.
5. Replace the fuel tank cap and wait for 5 minutes for excess fuel (petrol) to evaporate, before starting the engine.

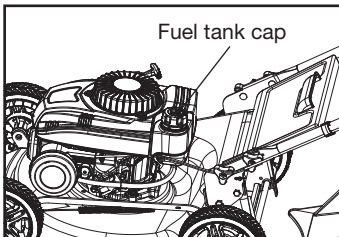

GZ132/GZ149 engine (NP130/NP150)

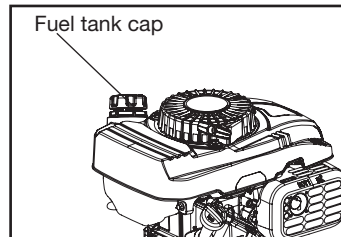

GZ-X196 engine (XP200)

ADJUSTMENT

Adjusting cutting height



WARNING! Stop and turn off the engine before adjusting the cutting height.

1. The cutting height has 10 settings, ranging from 15 mm to 80 mm.
2. Pull the cutting height adjusting handle out and move it to the desired cutting height notch.

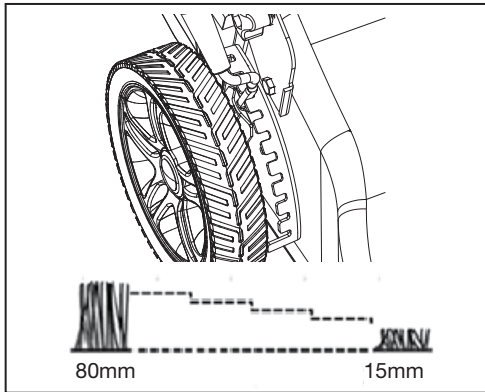

OPERATION

Starting and stopping the engine



WARNING! The blade will rotate as soon as the engine is started.



WARNING! The mower is for outdoor use only. Do not start the engine in an enclosed or poorly ventilated area. The exhaust gas contains toxic gases.



WARNING! Keep hands, feet, hair and clothes away from the moving parts of the mower.



WARNING! The engine will be hot during the operation.



WARNING! Make sure the blade is securely fastened before starting the engine.



CAUTION! Before starting the engine, make sure that spark plug lead is connected to the spark plug, the engine is filled with engine oil and fuel (petrol).

1. Press the primer bulb 3-5 times.
2. Move the throttle lever to the rabbit position.
3. Stand behind the mower. Pull the engine starter handle lightly out approximately 10-15 cm until you feel resistance, then pull the cord rapidly.
4. Once the engine is running, return the engine starter handle gently. Note: Depending on the condition of your lawn, you can move the throttle lever to the low speed position to save petrol consumption.
5. Move the throttle lever to STOP position to stop the engine.

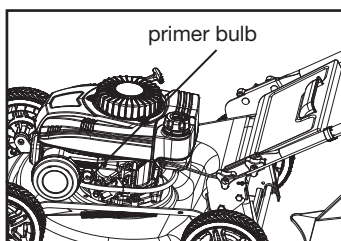
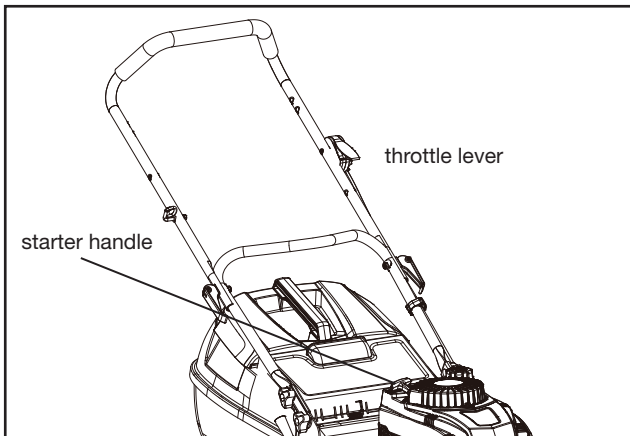

MAINTENANCE AND STORAGE



WARNING! Disconnect the spark plug lead from the spark plug before maintenance.

Maintenance schedule

The following maintenance schedule is recommended:

	12 hours of use	24 hours of use	36 hours of use
Engine oil	check	change	check
Air filter	clean	clean	clean
Spark plug	check	clean	check

Note: The engine oil should be changed after the first 8 hours of use.

Emptying the grass catcher



WARNING! Stop the engine and wait until the blade is completely stopped before removing the grass catcher.



WARNING! Use a brush to remove the grass clippings on the discharge chute, blade or under the deck. Do not remove the grass clippings by hand.

1. Lift the rear flap and remove the grass catcher from the mower.
2. Empty the grass in the grass catcher and put the grass catcher back onto the mower.

Cleaning a flooded engine

1. If the engine cannot start after several trials, the engine may be flooded with excess fuel.
2. To clear a flooded engine, move the throttle lever to the STOP position.
3. Remove the spark plug and wipe it dry with a cloth.
4. Wait for 5 minutes and then reinstall the spark plug.
Note: install the spark plug carefully by hand to avoid cross threading. After the spark plug is seated, tighten the spark plug with a 1/8 or 1/4 turn.
5. After the spark plug is cleaned, move the throttle lever to RABBIT position and start the engine.

Adjusting the spark plug gap

1. Remove the spark plug from the mower.
2. Clean the spark plug with a wire brush.

3. Use a feeler guage and set the gap of the spark plug to 0.7-0.8 mm.
4. Reinstall the spark plug.

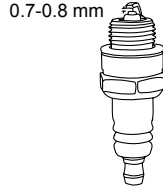

Cleaning the air filter

1. Unclip and remove the air filter cover.
2. Remove the air filter element.
3. Tap the air filter element on a hard surface several times to remove the dirt.
Note: Never use petrol or inflammable solvents to wash the air filter element. Clean the air filter element with compressed air or by tapping it.
4. If the air filter element is very dirty, replace with a new one.
5. Reinstall the air filter element and close the air filter cover.

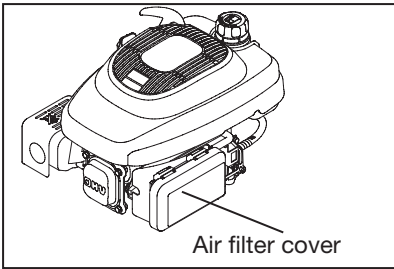

GZ-X196 engine (XP200)

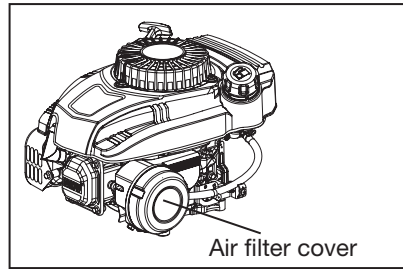

GZ132/GZ149 engine (NP130/NP150)

Changing engine oil

1. Remove the oil filler cap and dipstick and tilt the mower, drain the oil into a container.
2. After draining the engine oil, wipe away any spillages.
3. Refill the engine oil.
4. Check the engine oil level, the engine oil level must be between MIN and MAX marks on the dipstick.
5. Put the oil filler cap and dipstick back and tighten.
6. Start the engine and allow it to run for a few minutes.
7. Stop the engine, wait for one minute and check the oil level again. Top up the engine oil if necessary.

Replacing blades

1. Stop the engine and disconnect the spark plug lead before replacing the blades.
2. Tilt the mower upright.
3. Hold the blade disc firmly to prevent it from turning by inserting a piece of timber between the blades and the deck.
4. Loosen the blade setting bolts and remove the blades.
5. Replace the blades and secure the blades with the blade setting bolts.

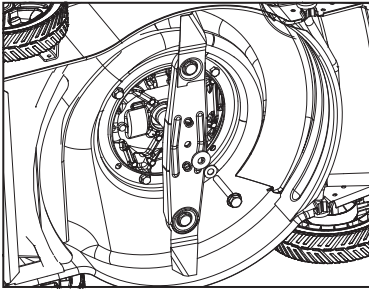

Oval disc 2 blades
(GZ132)

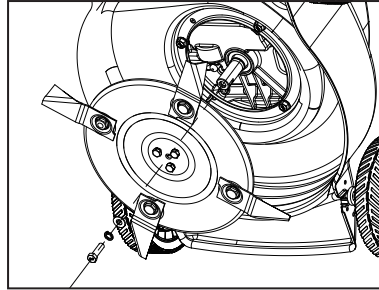

Round disc 4 blades
(GZ149 / GZ-X196)

Storing the mower

Fuel can become stale when stored over 30 days, Stale fuel causes acid and gum deposits to form in the fuel system. Drain the fuel before long time storage.

TROUBLESHOOTING

Problem	Possible cause	Possible solution
Noisy and vibrates heavily	Screws/bolts are loose	Tighten the screws/bolts
	Blade is loose	Tighten the blade
	Blade is unbalanced	Balance the blade
Engine cannot start	Throttle lever at incorrect position	Check the throttle lever
	Fuel tank is empty	Refill the fuel
	Spark plug is flooded	Clean and dry the spark plug
Engine runs rough	Air filter is dirty	Clean the air filter
	Spark plug is dirty	Clean the spark plug
Uneven mowing results	Blade is blunt	Sharpen the blade
	Cutting height too low	Set the correct cutting height
Grass catcher cannot fully filled	Grass catcher is clogged	Empty the grass catcher
	Cutting height is too low	Adjust the cutting height
	Grass is wet	Wait till the grass is dry before mowing
	Discharge chute is blocked	Clean the discharge chute
	Underside of the mower deck is clogged	Clean the underside of the mower deck

WARRANTY

This product is covered by a 2 year parts and labour warranty against manufacturing defects. Our goods come with guarantees that cannot be excluded under the Australian Consumer Law.

You are entitled to a replacement or refund for a major failure and for compensation for any other reasonably foreseeable loss or damage. You are also entitled to have the goods repaired or replaced if the goods fail to be of acceptable quality and the failure does not amount to a major failure.

This warranty will not apply:

- (i) where this product has been subjected to misuse, abuse, accident or want of care;
- (ii) where this product has been used for a purpose for which it was not designed or is not suited;
- (iii) where the service of this product has been undertaken by a non-authorized person or company or if non-approved parts have been used;
- (iv) where this product has been used for industrial or commercial purposes . Should service become necessary during the warranty period, the purchaser should contact your dealer.

In order to obtain warranty service, the purchaser must present the store receipt showing the name of the retailer and the date of purchase.

The period of the warranty begins from the original date of purchase, notwithstanding any subsequent repair or parts replacement.

Purchaser shall be responsible for all transport charges to and from the Authorised Service Centre.

Damage in transit is not covered by this warranty. The purchaser should remove from the product any liquids (if applicable) before sending the product for service or repair.

The product should be packed securely to prevent damage.

WARRANTY EXCLUSIONS

Wear parts or service related parts required when performing normal and regular maintenance of this product are not covered by warranty unless it is found to be defective by an Authorised Service Centre.

These include, but are not limited to: Spark Plugs, Carburettor Adjustments, Lubricants, Engine Tune-ups, Filters.