

KMA 80.0 R

STIHL



2 - 23 Instruction Manual



Contents

1	Introduction.....	2
2	Guide to Using this Manual.....	2
3	Overview.....	3
4	Safety Precautions.....	4
5	Preparing KombiMotor for Operation.....	9
6	Charging the Battery, LEDs.....	9
7	Assembling the KombiMotor.....	10
8	Adjusting KombiMotor for User.....	10
9	Removing and Fitting the Battery.....	11
10	Switching the KombiMotor On/Off.....	11
11	Checking KombiEngine and Battery.....	12
12	Operating the KombiMotor.....	12
13	After Finishing Work.....	12
14	Transporting.....	13
15	Storing.....	13
16	Cleaning.....	14
17	Maintenance and Repairs.....	14
18	Troubleshooting.....	14
19	Specifications.....	15
20	Combinations with KombiTools.....	16
21	Combinations of Carrying Systems.....	17
22	Spare Parts and Accessories.....	17
23	Disposal.....	17
24	EC Declaration of Conformity.....	18
25	UKCA Declaration of Conformity.....	18
26	Addresses.....	19
27	General Power Tool Safety Warnings.....	19

1 Introduction

Dear Customer,

Thank you for choosing STIHL. We develop and manufacture our quality products to meet our customers' requirements. The products are designed for reliability even under extreme conditions.

STIHL also stands for premium service quality. Our dealers guarantee competent advice and instruction as well as comprehensive service support.

STIHL expressly commit themselves to a sustainable and responsible handling of natural resources. This user manual is intended to help you use your STIHL product safely and in an environmentally friendly manner over a long service life.

We thank you for your confidence in us and hope you will enjoy working with your STIHL product.



Dr. Nikolas Stihl

IMPORTANT! READ BEFORE USING AND KEEP IN A SAFE PLACE FOR REFERENCE.

2 Guide to Using this Manual

2.1 Applicable Documents

The local safety regulations apply.

- ▶ In addition to this user manual, you should also read, understand and retain the following documents:
 - User manual of the STIHL KombiTool being used
 - User manual and packaging of the cutting attachment being used
 - Safety notices and precautions for the STIHL AK battery.
 - Safety information for STIHL batteries and products with built-in battery:
www.stihl.com/safety-data-sheets

2.2 Symbols used with warnings in the text

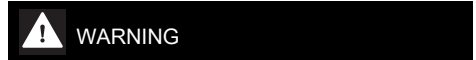

- This symbol indicates dangers that can cause serious injuries or death.
 - ▶ The measures indicated can avoid serious injuries or death.

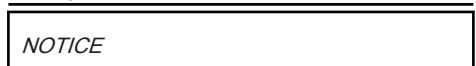

- This symbol indicates dangers that can cause damage to property.
 - ▶ The measures indicated can avoid damage to property.

2.3 Symbols in Text



This symbol refers to a chapter in this instruction manual.

3 Overview

3.1 KombiEngine and Battery

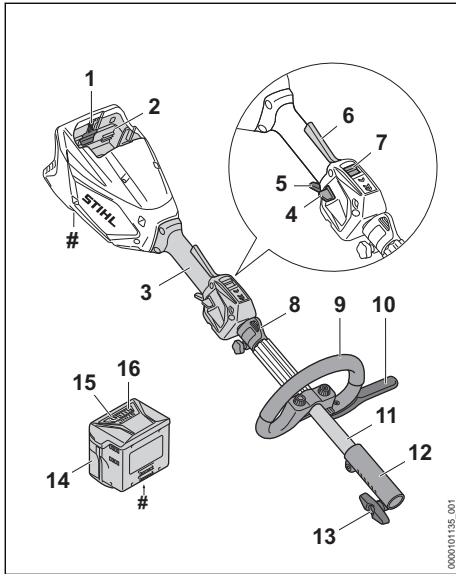

- 1 Locking lever**
The locking lever holds the battery in the battery compartment.
- 2 Battery compartment**
The battery compartment holds the battery.
- 3 Control handle**
For operating, holding and controlling the KombiEngine.
- 4 Release slide**
The release slide releases the trigger.
- 5 Trigger**
Switches the KombiEngine on and off.
- 6 Ergo lever**
The Ergo lever holds the release slide in position when the trigger is released.
- 7 Power setting switch**
The power setting switch is used to select the power level.
- 8 Carrying ring**
The carrying ring is for attaching the carrying system.
- 9 Loop handle**
For holding and controlling the KombiEngine.

10 Barrier bar

The barrier bar maintains a safe distance between the operator's leg and a metal cutting attachment.

11 Shaft

The shaft connects all components.

12 Coupling sleeve

The coupling sleeve connects the KombiEngine to the KombiTool.

13 Wing screw

The wing screw secures the KombiTool to the shaft.

14 Battery

The battery supplies the KombiEngine.

15 LEDs

The LEDs indicate the state of charge of the battery and any faults.

16 Pushbutton

The LEDs indicate the state of charge of the battery and any faults.

Rating plate with the machine number

3.2 Symbols

Meaning of symbols that may be on the KombiEngine, the battery and the charger:



1 LED lights up steady red. The battery is too warm or too cold.



4 LEDs flash red. There is a fault in the battery.



The LED lights up steady green, and the LEDs on the battery light up steady or flash green. The battery is charging.



The LED flashes red. There is no electrical contact between the battery and the charger or there is a fault in the battery or in the charger.



Guaranteed sound power level in accordance with Directive 2000/14/EC in dB(A) for the purpose of comparing the sound emissions of products.



The information next to the symbol indicates the energy content of the battery according to the cell manufacturer's specification. The energy content available in operation is lower.



Operate the electric product in a dry place, indoors only.



Do not dispose of the product with domestic waste.





Maximum power level.



ECO power level.

4 Safety Precautions

4.1 Warning Symbols

Meanings of warning symbols on the KombiEngine, the battery or the charger:



Observe safety warnings and take the necessary precautions.



Read and understand the user manual and keep it in a safe place for reference.



Remove the battery during work interruptions, transport, storage, maintenance or repair.



Protect the KombiEngine and the charger from rain and dampness.



Maintain a safe distance.



Protect the battery against heat and fire.



Protect the battery against rain and moisture and do not immerse it in liquids.

4.2 Intended Use

The STIHL KMA 80.0 R KombiEngine is designed to power a number of different STIHL KombiTools.

The KombiEngine must not be used in the rain.

The STIHL AK battery powers the KombiEngine.

The STIHL AL 101 charger is used to charge the STIHL AK battery.

⚠ WARNING

- Batteries and chargers not explicitly approved by STIHL for the KombiEngine may cause a

fire or explosion. Persons may be seriously or fatally injured, and property may be damaged.

- ▶ Use the KombiEngine with a STIHL AK battery.
- ▶ Recharge the STIHL AK battery with a STIHL AL 101, AL 301 or AL 501 charger.
- Using the KombiEngine, battery or charger for purposes for which they were not designed may result in serious or fatal injuries, and damage to property may occur.
 - ▶ Use the KombiEngine, battery and charger as described in this User Manual.

4.3 Requirements concerning the user

⚠ WARNING

- Users who have had no instruction cannot recognize or assess the risks involved in using the KombiEngine or battery. The user or other persons may sustain serious or fatal injuries.
 - ▶ Read, understand and keep the User Manual.
- ▶ If the KombiEngine or battery is passed on to another person: Always give them the User Manual.
- ▶ Make sure that the user meets the following conditions:
 - The user is rested.
 - The user has good hearing and visual faculties and the necessary physical and mental fitness to operate and work with the KombiEngine or batteries. If the user is able to operate the equipment but has physical, sensory or mental restrictions, the user may only work with the equipment under the supervision of or after receiving instruction from a responsible person.
 - The user is able to recognize and assess the risks involved in using the KombiEngine and batteries.
 - The user is an adult, or is being trained in an occupation under supervision according to national regulations.
 - The user has received instruction from a STIHL dealer or other experienced user before working with the KombiEngine for the first time.
 - The user is not under the influence of alcohol, medicines or drugs.
- ▶ If you have any doubts, be sure to consult a STIHL dealer.

4.4 Clothing and Equipment

▲ WARNING

- Long hair can be pulled into the KombiMotor during operation. This can result in serious injuries.
 - ▶ Tie up long hair so that it is above shoulder level.
- Falling objects can cause head injuries.
 - ▶ If there is a danger of falling objects during operation: Wear a safety hard hat.
- Dust can be whipped up during operation: Whipped up dust can damage the respiratory passages and cause allergic reactions.
 - ▶ If dust is generated: Wear a dust respirator mask.
- Unsuitable clothing can snag on wood, brush or the KombiMotor. Not wearing suitable clothing may result in serious injury.
 - ▶ Wear snug-fitting clothing.
 - ▶ Do not wear a scarf or jewelry.
- Wearing unsuitable footwear may cause you to slip or stumble. This can result in personal injury.
 - ▶ Wear sturdy enclosed footwear with non-slip soles.

4.5 Work Area and Surroundings

4.5.1 KombiEngine

▲ WARNING

- Bystanders, children and animals cannot recognize or assess the dangers of the KombiEngine. Bystanders, children and animals may be seriously injured.
 - ▶ Keep bystanders, children and animals away from the working area.
 - ▶ Do not leave the KombiEngine unattended.
 - ▶ Make sure that children cannot play with the KombiEngine.
- Electrical components of the KombiEngine can produce sparks. Sparks may cause fires and explosions in highly flammable or explosive environments. Persons may be seriously or fatally injured and property may be damaged.
 - ▶ Do not work in a highly flammable or explosive environment.

4.5.2 Battery

▲ WARNING

- Bystanders, children and animals cannot recognize or assess the dangers of the battery. Bystanders, children and animals may be seriously injured.

- ▶ Keep bystanders, children and animals away from the work area.
- ▶ Do not leave the battery unattended.
- ▶ Make sure that children cannot play with the battery.
- The battery is not protected against all ambient conditions. If the battery is exposed to certain ambient conditions, the battery may catch fire, explode or be irreparably damaged. This may result in serious injury to people and damage to property.
 - ▶ Protect battery from heat and fire.
 - ▶ Do not throw the battery into a fire.



- ▶ Do not charge, use and store the battery outside of the specified temperature limits, 19.4.
- ▶ Protect the battery from rain and moisture and do not immerse it in liquids.
- ▶ Keep battery away from small metal parts.
- ▶ Do not expose the battery to high pressure.
- ▶ Do not expose the battery to microwaves.
- ▶ Protect the battery from chemicals and salts.



4.5.3 Charger

▲ WARNING

- Bystanders and children are not aware of and cannot assess the dangers of a charger or electric current. Bystanders, children and animals may be seriously or fatally injured.
 - ▶ Keep bystanders, children and animals away from the work area.
 - ▶ Make sure that children cannot play with the charger.
- The charger is not waterproof. If you work in the rain or in a damp environment, an electric shock may occur. The user may be injured and the charger may be damaged.
 - ▶ Do not operate it in the rain or in a damp environment.



- The charger is not protected against all ambient conditions. If the charger is exposed to certain ambient conditions, it may catch fire or explode. This may result in serious injury to people and damage to property.
 - ▶ Operate the charger in an enclosed, dry room.
 - ▶ Do not operate the charger in a flammable environment or in an explosive environment.

- ▶ Do not operate the charger on a readily combustible surface.
- ▶ Do not use and store the charger outside of the specified temperature limits,  19.4.
- People may trip over the connecting cable. People may be injured and the charger may be damaged.
 - ▶ Lay the connecting cable flat on the floor.

4.6 Safe Condition

4.6.1 KombiEngine

The KombiEngine is in a safe condition if the following points are observed:

- The KombiEngine is not damaged.
- The KombiEngine is clean.
- The controls function properly and have not been modified.
- An approved KombiTool listed in this User Manual is mounted.
- The KombiTool is correctly mounted.
- Original STIHL accessories designed for this KombiEngine model are fitted.
- The accessories are correctly attached.

WARNING

- If not in safe condition, components may no longer operate correctly and safety devices may be disabled. This may result in serious or fatal injury to people.
 - ▶ Work only with an undamaged KombiEngine.
 - ▶ If the KombiEngine is dirty: Clean the KombiEngine.
 - ▶ Do not modify the KombiEngine. Exception: Mounting an approved KombiTool listed in this User Manual.
 - ▶ If the controls do not function properly: Do not work with the KombiEngine.
 - ▶ Fit original STIHL accessories designed for this KombiEngine model.
 - ▶ Mount the KombiTool as described in the User Manual supplied with the KombiTool.
 - ▶ Attach accessories as described in this User Manual or in the User Manual for the accessories.
 - ▶ Never insert objects in the openings of the KombiEngine.
 - ▶ Replace worn or damaged labels.
 - ▶ If you have any doubts, be sure to consult a STIHL dealer.

4.6.2 Battery

The battery is in a safe condition if the following points are observed:

- Battery is undamaged.
- The battery is clean and dry.

- Battery functions properly and has not been modified.

WARNING

- A battery that is not in a safe condition cannot operate safely. Persons may be seriously injured.
 - ▶ Never work with a damaged battery.
 - ▶ Never attempt to charge a damaged or defective battery.
 - ▶ If the battery is dirty: Clean the battery.
 - ▶ If the battery is wet or damp: Allow the battery to dry,  19.5.
 - ▶ Never attempt to modify the battery.
 - ▶ Never insert objects in the battery's openings.
 - ▶ Never bridge the battery's contacts with metallic objects (short circuit).
 - ▶ Do not open the battery.
 - ▶ Replace worn or damaged labels.
- Fluid may leak from a damaged battery. If that liquid comes into contact with the skin or eyes, the skin or eyes may be irritated.
 - ▶ Avoid contact with the liquid.
 - ▶ If skin contact occurs: Wash affected areas of skin with plenty of water and soap.
 - ▶ In the event of contact with eyes: Rinse eyes with plenty of water for at least 15 minutes and consult a doctor.
- A damaged or defective battery may smell unusual, emit smoke or burn. Persons may be seriously or fatally injured, and property may be damaged.
 - ▶ If the battery smells unusual or emits smoke: do not use the battery and keep it away from combustible substances.
 - ▶ If the battery catches fire: Attempt to extinguish the battery with a fire extinguisher or water.

4.6.3 Charger

The charger is in a safe condition if the following points are observed:

- Charger is undamaged.
- Charger is clean and dry.

WARNING

- If components do not comply with safety requirements, they will no longer function properly and safety devices may be rendered inoperative. This can result in serious or fatal injuries.
 - ▶ Do not use a damaged charger.
 - ▶ If the charger is dirty or wet: Clean the charger and allow it to dry.
 - ▶ Never attempt to modify the charger.

- ▶ Never insert objects in the charger's openings.
- ▶ Never bridge the charger's contacts with metallic objects (short circuit).
- ▶ Do not open the charger.

4.7 Working

⚠ WARNING

- In certain situations, the user may no longer be able to concentrate on their work. This may result in the user stumbling, falling and suffering serious injury.
 - ▶ Keep calm and plan your work.
 - ▶ If light and visibility are poor: Do not work with the KombiEngine.
 - ▶ Use the KombiEngine without assistance.
 - ▶ Watch out for obstacles.
 - ▶ Work standing on the ground and keep your balance. If you have to work at a height: Use a mobile elevating work platform or secure scaffolding.
 - ▶ If you start feeling fatigue: Take a break.
- If the behavior of the KombiEngine changes during operation or feels unusual, it may no longer be in a safe condition. This may result in serious injury to people and damage to property.
 - ▶ Stop working, remove the battery and consult a STIHL servicing dealer.
- Vibrations may occur while using the KombiEngine.
 - ▶ Wear gloves.
 - ▶ Take breaks.
 - ▶ If signs of a circulatory disturbance occur: Consult a doctor.
- In an emergency, the user may start to panic and forget to take off the carrying system. This may result in serious injury to the user.
 - ▶ Practice taking off the carrying system.

⚠ DANGER

- If working near live wires, the KombiEngine may come into contact with live wires and damage them. This may result in serious or fatal injury to the user.



- ▶ Maintain a clearance of 15 meters from live cables.

4.8 Transporting

4.8.1 KombiEngine

⚠ WARNING

- The KombiEngine may turn over or shift during transport. Persons may be injured or property damaged.



- ▶ Remove the battery.

- ▶ If a KombiTool is mounted: Transport the KombiEngine as described in the User Manual supplied with the KombiTool.
- ▶ Secure the KombiEngine with lashing. Secure the KombiEngine with lashing straps or a net to prevent it turning over and moving. straps or a net to prevent it turning over and moving.

4.8.2 Battery

⚠ WARNING

- The battery is not protected against all ambient conditions. The battery may be damaged if it is exposed to certain ambient conditions, and damage to property may occur.
 - ▶ Never transport a damaged battery.
- The battery may turn over or shift during transport. This may result in injury to people and damage to property.
 - ▶ Pack the battery in packaging in such a way that it cannot move.
 - ▶ Secure the packaging so that it cannot move.

4.8.3 Charger

⚠ WARNING

- The charger may turn over or move while being transported. This may result in personal injuries and damage to property.
 - ▶ Disconnect the plug from the wall outlet.
 - ▶ Remove the battery.
 - ▶ Secure the charger with lashing straps, belts or a net to prevent it turning over and moving.
- The connecting cable must not be used for carrying the charger. The connecting cable and the charger may be damaged.
 - ▶ Wind up the connecting cable and attach it to the charger.

4.9 Storing

4.9.1 KombiEngine

⚠ WARNING

- Children are not aware of and cannot assess the dangers of the KombiEngine and may be seriously injured.



- Remove the battery.

- Store the KombiEngine out of the reach of children.

- Dampness may corrode the electrical contacts on the KombiEngine and metal components. The KombiEngine may be damaged.



- Remove the battery.

- Store the KombiEngine in a clean and dry condition.

4.9.2 Battery

⚠ WARNING

- Children are not aware of and cannot assess the dangers of the battery. Children may be seriously injured.
 - Store the battery out of the reach of children.
- The battery is not protected against all ambient conditions. If the battery is exposed to certain ambient conditions, the battery may be irreparably damaged.
 - Store the battery in a clean and dry condition.
 - Store the battery in an enclosed space.
 - Store the battery separately from the KombiEngine.
 - If the battery is stored in the charger, disconnect the mains plug and store the battery at a state of charge between 40% and 60% (2 lit green LEDs).
 - Do not store the battery outside of the specified temperature limits,  19.4.

4.9.3 Charger

⚠ WARNING

- Children are not aware of and cannot assess the dangers of a charger. Children can be seriously injured or killed.
 - Disconnect the plug from the wall outlet.
 - Store the charger out of reach of children.

- The charger is not protected against all ambient conditions. If the charger is exposed to certain ambient conditions, the charger may be damaged.
 - Disconnect the plug from the wall outlet.
 - If the charger is hot: Allow the charger to cool down.
 - Store the charger in a clean, dry place.
 - Store the charger in an enclosed room.
 - Do not store the charger outside of the specified temperature limits,  19.4.
- The connecting cable should not be used for carrying the charger or hanging up the charger. The connecting cable and the charger may be damaged.
 - Hold the charger by the housing in a secure grip. The charger is provided with a handle recess to make it easy to pick up the charger.
 - Hang the charger on the wall mounting.

4.10 Cleaning, Maintenance and Repair

⚠ WARNING

- The KombiEngine may start up unintentionally if the battery is left in place during cleaning, maintenance or repair operations. There is a risk of serious injury to people and damage to property.



- Remove the battery.

- Using harsh detergents, and cleaning with a water jet or sharp objects can damage the KombiEngine or battery. If the KombiEngine or battery is not cleaned correctly, components may no longer function properly or safety devices may be rendered inoperative. They may cause serious injury to persons.
 - Clean the KombiEngine and battery as described in this User Manual.
- If the KombiEngine or battery are not serviced or repaired correctly, components may no longer function properly or safety devices may be rendered inoperative. There is a risk of serious or fatal injury.
 - Do not attempt to service or repair the KombiEngine and battery.
 - If the KombiEngine or the battery require servicing or repairs: Contact your STIHL dealer for assistance.

5 Preparing KombiMotor for Operation

5.1 Preparing the KombiEngine for Operation

The following steps must be performed before commencing work:

- ▶ Ensure that the following components are in a safe condition:
 - KombiEngine, [19.5](#) 4.6.1.
 - KombiTool as described in the user manual supplied with the KombiTool.
 - Battery, [19.5](#) 4.6.2.
- ▶ Check the battery, [19.5](#) 11.2.
- ▶ Fully charge the battery, [19.5](#) 6.1.
- ▶ Clean the KombiEngine, [19.5](#) 16.1.
- ▶ Mount the loop handle, [19.5](#) 7.1.
- ▶ If an FS KombiEngine or a RG KombiEngine is used: mount the barrier bar, [19.5](#) 7.2.
- ▶ Mount the KombiTool as described in the user manual supplied with the KombiTool.
- ▶ If an FS-KM, RG-KM or HL-KM is used: put on and adjust the carrying system, [19.5](#) 8.1.
- ▶ Adjust the loop handle, [19.5](#) 8.2.
- ▶ Check the controls, [19.5](#) 11.1.
- ▶ If you cannot carry out these steps: do not use your KombiEngine and contact your STIHL authorized dealer for assistance.

6 Charging the Battery, LEDs

6.1 Charging the battery

The charging time depends on various factors, e.g. the battery temperature or the ambient temperature. For optimum performance, observe the recommended temperature ranges, [19.5](#) 19.5. The actual charging time may vary from the charging time indicated. The charging time is indicated at www.stihl.com/charging-times.

The charging process starts automatically when the mains plug is plugged into a socket and the battery is inserted into the charger. The charger switches off automatically when the battery is fully charged.

The battery and the charger warm up during charging.

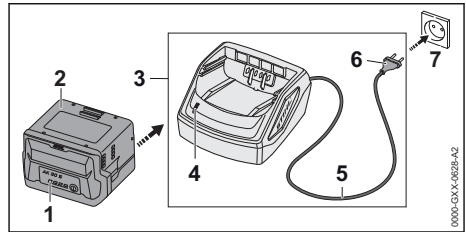

- ▶ Plug the mains plug (6) into an easily accessible socket (7). The charger (3) will run a self-test. The LED (4) will glow green for about 1 second and red for about 1 second.
- ▶ Routing the connecting cord (5).
- ▶ Insert the battery (2) in the guides in the charger (3) and press it home as far as stop. The LED (4) glows green. The LEDs (1) glow green and the battery (2) is being charged.
- ▶ When the LED (4) and the LEDs (1) on the battery no longer light up: The battery (2) is fully charged and can be removed from the charger (3).
- ▶ If the charger (3) is no longer required: Disconnect the mains plug (6) from the wall outlet (7).

6.2 Displaying the state of charge

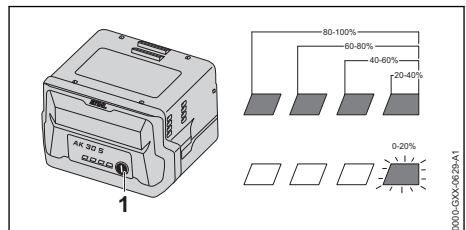

- ▶ Depress the pushbutton (1). The LEDs light up green for about 5 seconds and indicate the state of charge.
- ▶ If the LED on the right flashes green: Charge the battery.

6.3 LEDs on the Battery

The LEDs can indicate the state of charge of the battery or any faults. The LEDs can be steady green, steady red or flashing.

If the LEDs are steady or flashing green, this indicates the state of charge of the battery.

- ▶ If the LEDs glow or flash red: Troubleshooting, [19.5](#) 18.1. There is a malfunction in the KombiEngine or battery.

6.4 LED on Charger

The LED indicates the operating status of the charger.

If the LED glows green, the battery is being charged.

- ▶ If the LED flashes red: Rectify the malfunction. Malfunction in charger.

7 Assembling the KombiMotor

7.1 Mounting the Loop Handle

- ▶ Switch off the KombiEngine and remove the battery.

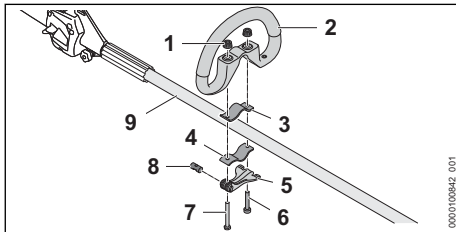

- ▶ Guide the pin (8) into the gap of the quick release clamp (5). Align the pin (8) so that the groove of the pin points down.
- ▶ Fit the clamp (3) in the loop handle so that the holes align.
- ▶ Place the loop handle (2) with clamp (3) on the shaft (9).
- ▶ Guide the long screw (7) through the bores in the pin and in the quick release clamp (5).
- ▶ Press the clamp (4) against the shaft and align it so that the holes are in alignment.
- ▶ Guide the short screw (6) through the holes.
- ▶ Guide the long screw (7) through the holes.
- ▶ Turn open the knurled nuts (1).
- ▶ Close the quick release clamp (5).

If the loop handle (2) cannot be adjusted any further, the loop handle is fixed.

- ▶ If the loop handle (2) can still be adjusted:
 - ▶ Fold open the quick release clamp (5).
 - ▶ Tighten the knurled nuts (1).
 - ▶ Close the quick release clamp (5). The loop handle (2) cannot be adjusted any further.
- ▶ If the quick release clamp (5) cannot be folded flat:
 - ▶ Fold open the quick release clamp (5).
 - ▶ Release the knurled nuts (1).
 - ▶ Close the quick release clamp (5).

The loop handle (2) cannot be adjusted any further.

7.2 Mounting the Barrier Bar

- ▶ Switch off the KombiEngine and remove the battery.

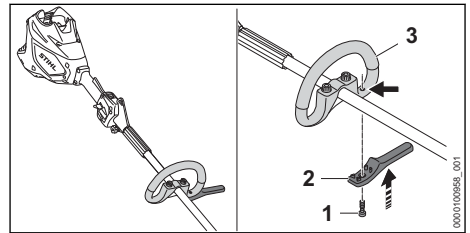

- ▶ Place the barrier bar (2) against the loop handle (3). The barrier bar must fit flush against the loop handle.
- ▶ Insert and firmly tighten the screw (1).

8 Adjusting KombiMotor for User

8.1 Fitting and Adjusting the Shoulder Strap

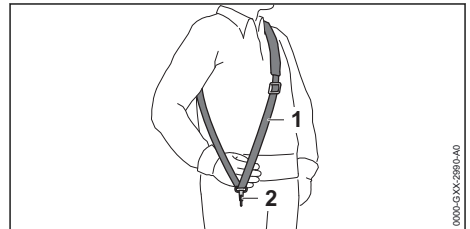

- ▶ Put on the shoulder strap (1).
- ▶ Adjust the shoulder strap (1) so that the carabiner (2) is about a hand's width below your right hip.

Other approved carrying systems are listed in this User Manual, [20.2](#).

8.2 Adjusting and Setting the Loop Handle

The loop handle can be set to different positions to suit the height and reach of the user.

- ▶ Switch off the KombiEngine and remove the battery.

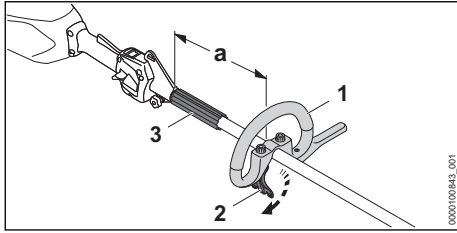

- ▶ Release the quick release clamp (2).
- ▶ Move the loop handle (1) to the required position and check that the following conditions are met:
 - The bump guard (3) fits between the loop handle (1) and the carrying ring.
 - If you are using a mowing head: $a = 30$ cm max.
 - If you are using a metal cutting attachment: $a = 25$ cm max.
- ▶ Close the quick release clamp (2) so that the loop handle (1) cannot be rotated on the shaft any longer.

9 Removing and Fitting the Battery

9.1 Inserting the Battery

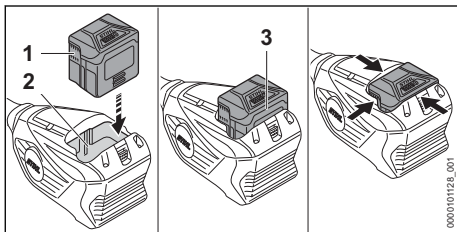

- ▶ Insert the battery (1) in the battery compartment (2) and press it home until you hear a click. The arrows (3) on the battery (1) are still visible and the battery (1) is held securely in the battery compartment (2). There is no electrical contact between the KombiEngine and battery (1).
- ▶ Insert the battery (1) into the battery compartment (2) as far as it will go. The battery (1) engages with a second click and fits flush with the KombiEngine's housing.

9.2 Removing the battery

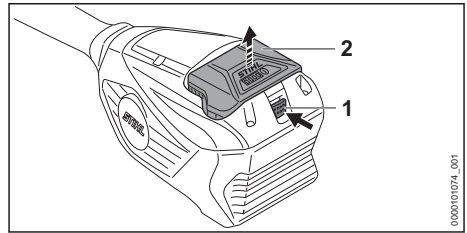

- ▶ Press the locking lever (1). The battery (2) is now unlocked and can be removed.

10 Switching the KombiMotor On/Off

10.1 Switching on the KombiEngine

- ▶ Hold the KombiEngine with your right hand by the control handle – wrap your thumb around the grip of the control handle (2).
- ▶ Hold the KombiEngine with your left hand by the loop handle – wrap your thumb around the loop handle.

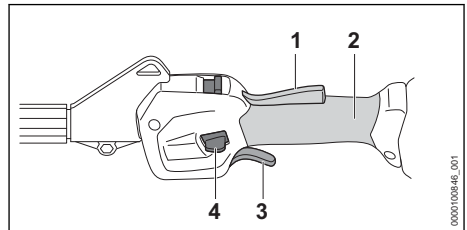

- ▶ Depress the Ergo lever (1) with your hand and hold it there.
- ▶ Depress the release slide (4) with your thumb.
- ▶ Depress the trigger (3) with your index finger and keep it pressed down. The KombiEngine accelerates and the KombiTool runs.

The more you depress the trigger (3), the faster the KombiTool runs.

At the maximum power level, the KombiEngine recognizes the installed KombiTool and automatically sets the maximum speed.

10.2 Switching the KombiEngine Off

- ▶ Release the trigger and trigger lockout.
- ▶ Wait until the KombiTool comes to a standstill.
- ▶ If the KombiTool continues to run: Remove the battery and contact your STIHL dealer for assistance. The KombiEngine is defective.

11 Checking KombiEngine and Battery

11.1 Checking the Controls

Release slide, Ergo lever and trigger

- ▶ Remove the battery.
- ▶ Try squeezing the trigger switch without activating the release slide.
- ▶ If the trigger can be pulled: Do not use your KombiEngine and contact your STIHL authorized dealer for assistance.
The release slide is faulty.
- ▶ Depress the release slide and hold it pressed.
- ▶ Depress and hold the Ergo lever.
- ▶ Depress the trigger.
The release slide can now be released.
- ▶ Release the trigger and the Ergo lever.
- ▶ If the release slide, trigger or Ergo lever is stiff or does not spring back to the initial position: Stop using the KombiEngine and contact a STIHL authorized dealer.
The release slide, trigger or the Ergo lever is defective.

Switching on the KombiEngine

- ▶ Insert the battery.
- ▶ Depress the release slide and hold it pressed.
- ▶ Depress and hold the trigger.
The KombiTool runs.
- ▶ When 3 LEDs flash red: Remove the battery and consult a STIHL authorized dealer.
There is a malfunction in the KombiEngine.
- ▶ Release the trigger.
The KombiTool stops running after a short while.
- ▶ If the KombiTool continues to run: Remove the battery and contact your STIHL authorized dealer for assistance.
The KombiEngine is defective.

11.2 Testing the Battery

- ▶ Press button on battery.
The LEDs glow or flash.
- ▶ If the LEDs do not glow or flash: Do not use the battery and contact your STIHL servicing dealer.
There is a malfunction in the battery.

12 Operating the KombiMotor

12.1 Holding and Controlling the KombiMotor



The correct way of holding and controlling the KombiMotor depends on the KombiTool you are using.

- ▶ Hold and control the KombiMotor as described in the instruction manual supplied with the KombiTool.

12.2 Setting the Power Level

Depending on the application, you can set 2 power levels. The position of the power level slide (1) indicates the selected power level.

The selected power level affects the battery's runtime.

-  : ECO power level, low speed
-  : maximum power level, maximum speed

When you select the maximum power level, the KombiEngine recognizes the installed KombiTool and automatically selects the appropriate speed.

When you select the ECO power level, the speed is reduced.

This can extend the battery running time.

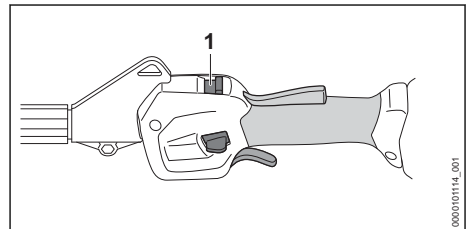

- ▶ Slide the power level slide (1) with your thumb to the selected position.

12.3 Operation

The method of operating the KombiEngine depends on the KombiTool you are using.

- ▶ Operate the KombiEngine as described in the user manual supplied with the KombiTool.

For optimum performance, observe the recommended temperature ranges,  19.5.

13 After Finishing Work

13.1 After Operation

- ▶ Switch off the KombiEngine and remove the battery.
- ▶ If the KombiEngine is wet: allow the KombiEngine to dry.

- ▶ If the battery is moist or wet: allow the battery to dry,  19.5.
- ▶ Clean the KombiEngine.
- ▶ Clean the battery.

14 Transporting

14.1 Transporting the KombiEngine

- ▶ Switch off the KombiEngine and remove the battery.

Carrying the KombiEngine

- ▶ Carry the KombiEngine properly balanced by the shaft with the KombiTool behind you.

Transporting the KombiEngine in the car

- ▶ Secure the KombiEngine so that it cannot turn over or move.

14.2 Transporting the Battery

- ▶ Switch off the KombiEngine and remove the battery.
- ▶ Check that the battery is in a safe condition.
- ▶ Pack the battery in packaging in such a way that it cannot move inside the packaging.
- ▶ Secure the packaging so that it cannot move.

The battery is subject to the Carriage of Dangerous Goods regulations. The battery is classified as UN 3480 (lithium ion batteries) and has been tested pursuant to UN Manual Tests and Criteria Part III, Subsection 38.3.

The transport regulations can be found at www.stihl.com/safety-data-sheets.

14.3 Transporting the Charger

- ▶ Disconnect the plug from the wall outlet.
- ▶ Remove the battery.
- ▶ Wind up the connecting cable and attach it to the charger.
- ▶ Transporting the charger in a vehicle: Secure the charger with lashing straps, belts or a net to prevent it turning over and moving.

15 Storing

15.1 Storing the KombiEngine

- ▶ Switch off the KombiEngine and remove the battery.
- ▶ Remove the KombiTool as described in the user manual supplied with the KombiTool.
- ▶ Ensure that the following conditions are met when storing the KombiEngine:
 - The KombiEngine cannot turn over or move.
 - The KombiEngine is out of the reach of children.
 - The KombiEngine is clean and dry.

15.2 Storing the Battery

STIHL recommends keeping the battery in a charging state between 40% and 60 % (2 lit green LEDs).

- ▶ The battery should be stored in such a way that the following conditions are fulfilled:
 - The battery is out of the reach of children.
 - The battery is clean and dry.
 - The battery is in an enclosed space.
 - The battery is separated from the KombiEngine.
 - If the battery is stored in the charger, disconnect the mains plug and store the battery at a state of charge between 40% and 60% (2 lit green LEDs).
 - Do not store the battery outside of the specified temperature limits,  19.4.

NOTICE

- If the battery is not stored as described in this user manual, the battery may become deeply discharged and irreparably damaged.
 - ▶ Charge a discharged battery before storing it. STIHL recommends storing the battery in a state of charge between 40% and 60% (2 lit green LEDs).
 - ▶ Store the battery separately from the KombiEngine.

15.3 Storing the Charger

- ▶ Disconnect the mains plug from the power supply.

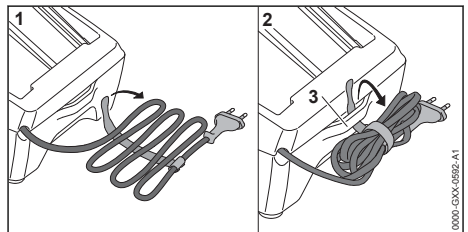

- ▶ Wind up the connecting cable and attach it to the charger.
- ▶ Observe the following points when storing the charger:
 - Charger is out of the reach of children.
 - The charger is clean and dry.
 - Charger is in an enclosed space.
 - The charger is not suspended from the connecting cable or the holder (3) for the connecting cable.
 - Do not store the charger outside of the specified temperature limits,  19.4.

16 Cleaning

16.1 Cleaning the KombiEngine

- ▶ Switch off the KombiEngine and remove the battery.
- ▶ Clean the KombiEngine with a damp cloth.
- ▶ Remove foreign objects from the battery compartment and clean battery compartment with a damp cloth.
- ▶ Clean electrical contacts in the battery compartment with a paintbrush or soft brush.

16.2 Cleaning the Battery

- ▶ Clean the battery with a damp cloth.

16.3 Cleaning the Charger

- ▶ Disconnect the mains plug from the power supply.
- ▶ Clean the charger with a damp cloth.
- ▶ Clean vents with a paintbrush.
- ▶ Clean the charger's electrical contacts with a paintbrush or a soft brush.

recommends the following maintenance intervals:

Annually

- ▶ Have the KombiEngine checked by a STIHL authorized dealer.

17.2 Repairing the KombiEngine

The KombiEngine cannot be repaired by the user.

- ▶ If the KombiEngine is defective or damaged: Do not use the KombiEngine and contact your STIHL dealer.

17.3 Servicing and Repairing the Battery

The battery requires no servicing and cannot be repaired.

- ▶ If the battery has a malfunction or is damaged: Replace the battery.

17 Maintenance and Repairs

17.1 Maintenance Intervals

Maintenance intervals depend on the ambient conditions and the operating conditions. STIHL

18 Troubleshooting

18.1 Troubleshooting the KombiEngine and the Battery

Fault	LEDs on the battery	Cause	Remedy
The KombiEngine does not start up when switched on.	1 LED flashes green.	State of charge of the battery is too low.	▶ Charge the battery.
	1 LED lights up red.	The battery is too warm or too cold.	▶ Remove the battery. ▶ Allow the battery to cool down or warm up.
	3 LEDs flash red.	There is a malfunction in the KombiEngine.	▶ Remove the battery. ▶ Clean electrical contacts in the battery compartment. ▶ Insert the battery. ▶ Switch on the KombiEngine. ▶ If 3 LEDs continue to flash red: Do not use your KombiEngine and contact your STIHL dealer for assistance.
	3 LEDs light up steady red.	The KombiEngine is too hot.	▶ Remove the battery. ▶ Allow the KombiEngine to cool down.
	4 LEDs flash red.	There is a fault in the battery.	▶ Remove the battery and reinsert it. ▶ Switch on the KombiEngine. ▶ If 4 LEDs continue to flash red: Do not use the battery; contact a STIHL authorized dealer.

Fault	LEDs on the battery	Cause	Remedy
		No electrical contact between the KombiEngine and battery.	<ul style="list-style-type: none"> ▶ Remove the battery. ▶ Clean electrical contacts in the battery compartment. ▶ Insert the battery.
		The KombiEngine or battery is damp.	▶ Allow the KombiEngine or battery to dry,  19.5.
		Trigger is depressed before operating the release slide.	▶ Switch on the KombiEngine as described in this user manual.
The KombiEngine cuts out during operation.	3 LEDs light up steady red.	The KombiEngine is too hot.	<ul style="list-style-type: none"> ▶ Remove the battery. ▶ Allow the KombiEngine to cool down.
		There is an electrical fault.	<ul style="list-style-type: none"> ▶ Remove the battery and reinsert it. ▶ Switch on the KombiEngine.
The KombiEngine runtime is too short.		The battery is not fully charged.	▶ Fully charge the battery.
		The battery service life has been exceeded.	▶ Replace the battery.
The power levels cannot be set.		The trigger is depressed and the KombiEngine switched on.	▶ Select the power level as described in this user manual.
Charging does not start when the battery is inserted into the charger.	1 LED lights up red.	The battery is too warm or too cold.	▶ Leave the battery inserted in charger. Charging starts automatically as soon as the permitted temperature range is reached.

18.2 Product Support and Assistance on Use

Product support and assistance on use are available from STIHL servicing dealers.

For contacts and other information, please visit <https://support.stihl.com> or www.stihl.com.

19 Specifications

19.1 STIHL KMA 80.0 R KombiEngine

- Permitted batteries:
 - STIHL AK
- Weight without KombiTool: 3.1 kg

For runtime, see www.stihl.com/battery-life.

19.2 STIHL AK Battery

- Battery technology: lithium-ion
- Voltage: 36 V
- Capacity in Ah: see rating label
- Energy content in Wh: see rating label
- Weight in kg: See rating label

19.3 STIHL AL 101 Charger

- Rated voltage: See rating plate
- Frequency: see rating plate
- Rated power: see rating plate
- Charging current: See rating plate

For charging times, see www.stihl.com/charging-times.

19.4 Temperature limits



WARNING

- The battery is not protected against all ambient conditions. If the battery is exposed to certain environmental conditions, it may catch fire or explode. This may result in serious injury to people and damage to property.
 - ▶ Do not charge the battery below -20°C or above 50°C.
 - ▶ Do not use the KombiEngine, battery or charger below -20°C or above +50°C.
 - ▶ Do not store the KombiEngine, battery or charger below -20°C or above +70°C.

19.5 Recommended Temperature Ranges

For optimum performance of the KombiEngine, the battery and the charger, observe the following temperature ranges:

- Charging: 5°C to 40°C
- Use: -10 °C to +40 °C
- Storage: -20°C to +50°C

If the battery is charged, used or stored outside the recommended temperature ranges, performance may be restricted.

If the battery is wet or moist, allow the battery to dry for at least 48 h between 15°C and 50°C and with less than 70% humidity. Higher humidity may extend the drying time.

19.6 Sound and vibration values

STIHL recommends wearing hearing protection.

The exact noise and vibration specifications depend on the KombiTool being used and are described in the user manual of the KombiTool.

- Sound pressure level L_{pA} ISO 10517, ISO 11201, ISO 22868: 76 dB(A) to 90 dB(A). The U value for the sound pressure level is 2.0 dB(A).
- Sound power level L_{WA} to ISO 3744, ISO 10517, ISO 22868: 88 dB(A) to 102 dB(A). The K value for sound power level is 2.0 dB(A).
- Vibration value a_{hv} to EN 50636-2-91, EN 50636-2-92, EN 50636-2-100, ISO 20643, ISO 22867
 - Control handle: 1.4 m/s² to 3.2 m/s². The K-value for the vibration level is 2.0 m/s².
 - Loop handle: 1.9 m/s² to 5.0 m/s². The K-value for the vibration level is 2.0 m/s².

The sound and vibration values indicated were measured according to a standardized test method and can be used as a basis for comparing electric power tools. The actual sound and vibration levels may vary from the values indicated, depending on the type of application and the accessories used. The sound and vibration levels indicated can be used for an initial estimate

20.2 STIHL FS-KM: Combinations of cutting attachments, deflectors and carrying systems

A combination of KombiEngine and STIHL FS-KM may be used with the following cutting attachments:

Cutting attachment	Deflector	Barrier bar	Carrying System
– PolyCut 18-2 (335 mm diameter) mowing head	– Deflector for mowing heads	– optional	– Shoulder strap – Full harness with quick-release system

of the sound and vibration load. The actual sound and vibration stress has to be estimated. The times can be taken into account in the estimate when the electric power tool is switched off and also when it is switched on but running without any load.

For information on compliance with the Physical Agents (Vibration) Directive 2002/44/EC, see www.stihl.com/vib.

19.7 REACH



REACH is an EC regulation and stands for the Registration, Evaluation, Authorisation and Restriction of Chemical substances.

For information on compliance with the REACH regulation see www.stihl.com/reach.

20 Combinations with KombiTools

20.1 KombiTool mounting options

The following KombiTools may be mounted:

- STIHL BG-KM: Blower
- STIHL BF-KM: Cultivator
- STIHL FBD-KM: Bed redefiner
- STIHL FCB-KM: Edger
- STIHL FCS-KM: Edger
- STIHL FH-KM 145°: Scrub cutter
- STIHL FS-KM: Brushcutter
 - Use the STIHL FS-KM KombiTool only in the specified combinations,  20.2.
 - Depending on the installed cutting tool, the STIHL FS-KM KombiTool must only be used with a mounted barrier bar,  7.
- STIHL HL-KM 0°: Gasoline extended hedge trimmer
- STIHL HL-KM 145°: Extended hedge trimmer
- STIHL HT-KM: Pole pruner
- STIHL KB-KM: Bristle brush
- STIHL KW-KM: Sweeper drum assembly
- STIHL RG-KM: Weeder
 - Use the STIHL RG-KM KombiTool with mounted barrier bar only,  7.
- STIHL SP-KM: Harvester

Cutting attachment	Deflector	Barrier bar	Carrying System
– PolyCut 28-2 (365 mm diameter) mowing head Mowing head with 2.4 mm diameter “round, quiet” mowing line: – AutoCut 25-2 mowing head – AutoCut C 26-2 mowing head – AutoCut 27-2 mowing head – DuroCut 20-2 mowing head – SuperCut 20-2 mowing head – TrimCut C 32-2 mowing head Mowing head with 2.7 mm diameter “round, quiet” mowing lines: – AutoCut 36-2 mowing head	(420 mm diameter) – Universal deflector with skirt and line limiting blade (420 mm diameter)		
– Grass cutting blade 230-2 (Ø 230 mm) – Grass cutting blade 230-4 (Ø 230 mm) – Grass cutting blade 230-8 (230 mm diameter) – Grass cutting blade 250-32 (Ø 250 mm) – Grass cutting blade 260-2 (260 mm diameter) – Brush knife 250-3 (250 mm diameter)	– Universal deflector without skirt (420 mm diameter)	– required	

21 Combinations of Carrying Systems

21.1 Combinations of Carrying Systems

Approved carrying systems are listed in this user manual:



Shoulder strap



Full harness

22 Spare Parts and Accessories

22.1 Spare parts and accessories

STIHL  These symbols indicate original STIHL spare parts and original STIHL accessories.

STIHL recommends the use of original STIHL spare parts and accessories.

Despite ongoing market observation, STIHL is unable to judge the reliability, safety and suitability of other manufacturers' spare parts and accessories; accordingly, STIHL cannot warrant for the use of those parts.

Original STIHL spare parts and original STIHL accessories are available from STIHL dealers.

23 Disposal

23.1 Disposing of the KombiEngine and battery

Contact the local authorities or your STIHL dealer for information on disposal.

Improper disposal can be harmful to health and pollute the environment.

- ▶ Take STIHL products including packaging to a suitable collection point for recycling in accordance with local regulations.
- ▶ Do not dispose with domestic waste.

24 EC Declaration of Conformity

24.1 STIHL KMA 80.0 R KombiEngine

ANDREAS STIHL AG & Co. KG
Badstraße 115
D-71336 Waiblingen

Germany

declares under our sole responsibility that

- Category: Cordless KombiEngine
- Manufacturer's brand: STIHL
- Model: KMA 80.0 R
- Serial identification number: FA08

conforms to the relevant provisions of Directives 2011/65/EU, 2006/42/EC, 2014/30/EU and 2000/14/EC and has been developed and manufactured in conjunction with the KombiTools listed in this user manual to comply with the following standards in the versions valid on the date of production: EN 55014-1, EN 55014-2, EN 62233, EN 60335-1, EN 62841-1 and EN ISO 12100, taking into account the standards EN 60335-2-72, EN 50636-2-92, EN 50636-2-100, ISO 11680-1, EN 62841-4-1, EN 62841-4-2 and EN 62841-4-4.

The KombiEngine described here may be operated only in conjunction with one of the KombiTools listed in this user manual.

The technical documents are stored at ANDREAS STIHL AG & Co. KG Produktzulassung.

The year of manufacture, country of manufacture and machine number are shown on the KombiEngine.

Waiblingen, 2022-10-15

ANDREAS STIHL AG & Co. KG

pp 

Robert Olma, Vice President, Regulatory Affairs & Global Governmental Relations

25 UKCA Declaration of Conformity

25.1 STIHL KMA 80.0 R KombiEngine

**UK
CA**

ANDREAS STIHL AG & Co. KG
Badstraße 115
D-71336 Waiblingen

Germany

declares under our sole responsibility that

- Category: Cordless KombiEngine
- Manufacturer's brand: STIHL
- Model: KMA 80.0 R
- Serial identification number: FA08

conforms to the relevant provisions of UK regulations The Restriction of the Use of Certain Hazardous Substances in Electrical and Electronic Equipment Regulations 2012, Supply of Machinery (Safety) Regulations 2008, Electromagnetic Compatibility Regulations 2016 and Noise Emission in the Environment by Equipment for use Outdoors Regulations 2001 and has been developed and manufactured in conjunction with the KombiTools listed in this instruction manual to comply with the following standards in the versions valid on the date of production:

EN 55014-1, EN 55014-2, EN 62233, EN 60335-1, EN 62841-1 und EN ISO 12100 taking into account standards EN 60335-2-72, EN 50636-2-92, EN 50636-2-100, ISO 11680-1, EN 62841-4-1, EN 62841-4-2 and EN 62841-4-4.

The KombiEngine described here may be operated only in conjunction with one of the KombiTools listed in this user manual.

The technical documentation is stored at ANDREAS STIHL AG & Co. KG.

The year of manufacture, country of manufacture and machine number are shown on the KombiEngine.

Waiblingen, 2022-10-15

ANDREAS STIHL AG & Co. KG

pp 

Robert Olma, Vice President, Regulatory Affairs & Global Governmental Relations

26 Addresses

www.stihl.com

27 General Power Tool Safety Warnings

27.1 Introduction

This chapter reproduces the pre-formulated, general safety precautions specified in the IEC 62841 standard for hand-held motor-operated electric tools.

STIHL is obliged to publish these texts.

The safety precautions and warnings on avoiding an electric shock given under "Electrical Safety" do not apply to STIHL cordless products.

WARNING

- **Read all safety warnings, instructions, illustrations and specifications provided with this power tool.** Failure to follow all instructions listed below may result in electric shock, fire and/or serious injury. **Save all warnings and instructions for future reference.**

The term "electric power tool" in the safety warnings refers to mains-operated (corded) power tools or battery-operated (cordless) power tools.

27.2 Work area safety

- a) **Keep work area clean and well lit.** Cluttered or dark areas invite accidents.
- b) **Do not operate power tools in explosive atmospheres, such as in the presence of flammable liquids, gases or dust.** Power tools create sparks which may ignite the dust or fumes.
- c) **Keep children and bystanders away while operating a power tool.** Distractions can cause you to lose control.

27.3 Electrical safety

- a) **Power tool plugs must match the outlet. Never modify the plug in any way. Do not use any adapter plugs with earthed (grounded) power tools.** Unmodified plugs and matching outlets will reduce risk of electric shock.
- b) **Avoid body contact with earthed or grounded surfaces, such as pipes, radiators, ranges and refrigerators.** There is an increased risk of electric shock if your body is earthed or grounded.

- c) **Do not expose power tools to rain or wet conditions.** Water entering a power tool will increase the risk of electric shock.
- d) **Do not abuse the cord. Never use the cord for carrying, pulling or unplugging the power tool. Keep cord away from heat, oil, sharp edges or moving parts.** Damaged or entangled cords increase the risk of electric shock.
- e) **When operating a power tool outdoors, use an extension cord suitable for outdoor use.** Use of a cord suitable for outdoor use reduces the risk of electric shock.
- f) **If operating a power tool in a damp location is unavoidable, use a residual current device (RCD) protected supply.** Use of an RCD reduces the risk of electric shock.

27.4 Personal safety

- a) **Stay alert, watch what you are doing and use common sense when operating a power tool. Do not use a power tool while you are tired or under the influence of drugs, alcohol or medication.** A moment of inattention while operating power tools may result in serious personal injury.
- b) **Use personal protective equipment. Always wear eye protection.** Protective equipment such as a dust mask, non-skid safety shoes, hard hat or hearing protection used for appropriate conditions will reduce personal injuries.
- c) **Prevent unintentional starting. Ensure the switch is in the off-position before connecting to power source and/or battery pack, picking up or carrying the tool.** Carrying power tools with your finger on the switch or energising power tools that have the switch on invites accidents.
- d) **Remove any adjusting key or wrench before turning the power tool on.** A wrench or a key left attached to a rotating part of the power tool may result in personal injury.
- e) **Do not overreach. Keep proper footing and balance at all times.** This enables better control of the power tool in unexpected situations.
- f) **Dress properly. Do not wear loose clothing or jewellery. Keep your hair and clothing away from moving parts.** Loose clothes, jewellery or long hair can be caught in moving parts.
- g) **If devices are provided for the connection of dust extraction and collection facilities, ensure these are connected and properly**

used. Use of dust collection can reduce dust-related hazards.

- h) **Do not let familiarity gained from frequent use of tools allow you to become complacent and ignore tool safety principles.** A careless action can cause severe injury within a fraction of a second.

27.5 Power tool use and care

- a) **Do not force the power tool. Use the correct power tool for your application.** The correct power tool will do the job better and safer at the rate for which it was designed.
- b) **Do not use the power tool if the switch does not turn it on and off.** Any power tool that cannot be controlled with the switch is dangerous and must be repaired.
- c) **Disconnect the plug from the power source and/or remove the battery pack, if detachable, from the power tool before making any adjustments, changing accessories, or storing power tools.** Such preventive safety measures reduce the risk of starting the power tool accidentally.
- d) **Store idle power tools out of the reach of children and do not allow persons unfamiliar with the power tool or these instructions to operate the power tool.** Power tools are dangerous in the hands of untrained users.
- e) **Maintain power tools and accessories. Check for misalignment or binding of moving parts, breakage of parts and any other condition that may affect the power tool's operation. If damaged, have the power tool repaired before use.** Many accidents are caused by poorly maintained power tools.
- f) **Keep cutting tools sharp and clean.** Properly maintained cutting tools with sharp cutting edges are less likely to bind and are easier to control.
- g) **Use the power tool, accessories and tool bits etc. in accordance with these instructions, taking into account the working conditions and the work to be performed.** Use of the power tool for operations different from those intended could result in a hazardous situation.
- h) **Keep handles and grasping surfaces dry, clean and free from oil and grease.** Slippery handles and grasping surfaces do not allow for safe handling and control of the tool in unexpected situations.

27.6 Service

- a) **Have your power tool serviced by a qualified repair person using only identical replacement parts.** This will ensure that the safety of the power tool is maintained.
- b) **Never service damaged battery packs.** Service of battery packs should only be performed by the manufacturer or authorized service providers.

27.7 Battery tool use and care

- a) **Recharge only with the charger specified by the manufacturer.** A charger that is suitable for one type of battery pack may create a risk of fire when used with another battery pack.
- b) **Use power tools only with specifically designated battery packs.** Use of any other battery packs may create a risk of injury and fire.
- c) **When battery pack is not in use, keep it away from other metal objects, like paper clips, coins, keys, nails, screws or other small metal objects, that can make a connection from one terminal to another.** Shorting the battery terminals together may cause burns or a fire.
- d) **Under abusive conditions, liquid may be ejected from the battery; avoid contact. If contact accidentally occurs, flush with water. If liquid contacts eyes, additionally seek medical help.** Liquid ejected from the battery may cause irritation or burns.
- e) **Do not use a battery pack or tool that is damaged or modified.** Damaged or modified batteries may exhibit unpredictable behaviour resulting in fire, explosion or risk of injury.
- f) **Do not expose a battery pack or tool to fire or excessive temperature.** Exposure to fire or temperature above 130 °C may cause explosion.
- g) **Follow all charging instructions and do not charge the battery pack or tool outside the temperature range specified in the instructions.** Charging improperly or at temperatures outside the specified range may damage the battery and increase the risk of fire.

27.8 Service

- a) **Have your power tool serviced by a qualified repair person using only identical replacement parts.** This will ensure that the safety of the power tool is maintained.

- b) **Never service damaged battery packs.** Service of battery packs should only be performed by the manufacturer or authorized service providers.

27.9 Hedge trimmer safety warnings

Safety instructions for hedge trimmers

- a) **Do not use the hedge trimmer in bad weather conditions, especially when there is a risk of lightning.** This decreases the risk of being struck by lightning.
- b) **Keep all power cords and cables away from cutting area.** Power cords or cables may be hidden in hedges or bushes and can be accidentally cut by the blade.
- c) **Wear ear protection.** Adequate protective equipment will reduce the risk of hearing loss.¹
- d) **Hold the hedge trimmer by insulated gripping surfaces only, because the blade may contact hidden wiring or its own cord.** Blades contacting a "live" wire may make exposed metal parts of the hedge trimmer "live" and could give the operator an electric shock.
- e) **Keep all parts of the body away from the blade. Do not remove cut material or hold material to be cut when blades are moving.** Blades continue to move after the switch is turned off. A moment of inattention while operating the hedge trimmer may result in serious personal injury.
- f) **When clearing jammed material or servicing the hedge trimmer, make sure all power switches are off and the battery pack is removed or disconnected.** Unexpected actuation of the hedge trimmer while clearing jammed material or servicing may result in serious personal injury.
- g) **Carry the hedge trimmer by the handle with the blade stopped and taking care not to operate any power switch.** Proper carrying of the hedge trimmer will decrease the risk of inadvertent starting and resultant personal injury from the blades.
- h) **When transporting or storing the hedge trimmer, always use the blade cover.** Proper handling of the hedge trimmer will decrease the risk of personal injury from the blades.

27.10 Additional safety instructions for extended-reach hedge trimmers

Extended-reach hedge trimmer safety warnings

- a) **Always use head protection when operating the extended-reach hedge trimmer overhead.** Falling debris can result in serious personal injuries.
- b) **Always use two hands when operating the extended-reach hedge trimmer.** Hold the extended-reach hedge trimmer with both hands to avoid loss of control.
- c) **To reduce the risk of electrocution, never use the extended-reach hedge trimmer near any electrical power lines.** Contact with or use near power lines may cause serious injury or electric shock resulting in death.

27.11 Grass Trimmer, Brush Cutter and Brush Saw Safety Warnings

- a) **Do not use the machine in bad weather conditions, especially when there is a risk of lightning.** This increases the risk of being struck by lightning.
- b) **Thoroughly inspect the area for wildlife where the machine is to be used.** Wildlife may be injured by the machine during operation.
- c) **Thoroughly inspect the area where the machine is to be used and remove all stones, sticks, wires, bones, and other foreign objects.** Thrown objects can cause personal injury.
- d) **Before using the machine, always visually inspect to see that the cutter or blade and the cutter or blade assembly are not damaged.** Damaged parts increase the risk of injury.
- e) **Follow instructions for changing accessories.** Improperly tightened blade security nuts or bolts may either damage the blade or result in it becoming detached.
- f) **The rated rotational speed of the blade must be at least equal to the maximum rotational speed marked on the machine.** Blades running faster than their rated rotational speed can break and fly apart.

¹Sound pressure level > 85 dB(A)

- g) **Wear eye, ear, head and hand protection.** Adequate protective equipment will reduce personal injury by flying debris or accidental contact with the cutting line or blade.
- h) **While operating the machine, always wear non-slip and protective footwear. Do not operate the machine when barefoot or wearing open sandals.** This reduces the chance of injury to the feet from contact with the moving cutters or lines.
- i) **While operating the machine, always wear safety footwear. Do not operate the machine when barefoot or wearing open sandals.** This reduces the chance of injury to the feet from contact with a moving cutter, line or blade.
- j) **While operating the machine, always wear long trousers.** Exposed skin increases the likelihood of injury from thrown objects.
- k) **Keep bystanders away while operating the machine.** Thrown debris can result in serious personal injury.
- l) **Always use two hands when operating the machine.** Holding the machine with both hands will avoid loss of control.
- m) **Hold the machine by insulated gripping surfaces only, because the cutting line or blade may contact hidden wiring or its own cord.** Cutting line or blades contacting a “live” wire may make exposed metal parts of the machine “live” and could give the operator an electric shock.
- n) **Always keep proper footing and operate the machine only when standing on the ground.** Slippery or unstable surfaces may cause a loss of balance or control of the machine.
- o) **Do not operate the machine on excessively steep slopes.** This reduces the risk of loss of control, slipping and falling which may result in personal injury.
- p) **When working on slopes, always be sure of your footing, always work across the face of slopes, never up or down and exercise extreme caution when changing direction.** This reduces the risk of loss of control, slipping and falling which may result in personal injury.
- q) **Keep all parts of the body away from the cutter, line or blade when the machine is operating. Before you start the machine, make sure the cutter, line or blade is not contacting anything.** A moment of inattention while operating the machine may result in injury to yourself or others.
- r) **Do not operate the machine above waist height.** This helps prevent unintended cutter or blade contact and enables better control of the machine in unexpected situations.
- s) **When cutting brush or saplings that are under tension, be alert for spring back.** When the tension in the wood fibres is released, the brush or sapling may strike the operator and/or throw the machine out of control.
- t) **Use extreme caution when cutting brush and saplings.** The slender material may catch the blade and be whipped toward you or pull you off balance.
- u) **Maintain control of the machine and do not touch cutters, lines or blades and other hazardous moving parts while they are still in motion.** This reduces the risk of injury from moving parts.
- v) **Carry the machine with the machine switched off and away from your body.** Proper handling of the machine will reduce the likelihood of accidental contact with a moving cutter, line or blade.
- w) **When transporting or storing the machine, always fit the cover on metal blades.** Proper handling of the machine will reduce the likelihood of accidental contact with the blade.
- x) **Only use replacement cutters, lines, cutting heads and blades specified by the manufacturer.** Incorrect replacement parts may increase the risk of breakage and injury.
- y) **When clearing jammed material or servicing the machine, make sure the switch is off and the battery pack is removed.** Unexpected starting of the machine while clearing jammed material or servicing may result in serious personal injury.

27.12 Blade thrust related warnings

Blade thrust is a sudden sideways, forward or backward motion of the machine, which may occur when the blade jams or catches on an object such as a sapling or a tree stump. It can be violent enough to cause the machine and/or operator to be propelled in any direction, and possibly lose control of the machine.

Blade thrust and its related hazards can be avoided by taking proper precautions as given below.

- a) **Maintain a firm grip with both hands on the machine and position your arms to resist**

- blade thrust. Position your body to the left side of the machine.** Blade thrust can increase the risk of injury due to the machine moving unexpectedly. Blade thrust can be controlled by the operator if proper precautions are taken.
- b) **If the blade binds, or when interrupting a cut for any reason, switch the machine off and hold the machine motionless in the material until the blade comes to a complete stop. While the blade is binding, never attempt to remove the machine from the material or pull the machine backward while the blade is in motion, otherwise blade thrust may occur.** Investigate and take corrective actions to eliminate the cause of blade binding.
 - c) **Do not use blunt or damaged blades.** Blunt or damaged blades increase the risk of jamming or catching on an object, resulting in blade thrust.
 - d) **Always maintain good visibility of the material being cut.** Blade thrust is more likely to occur in areas where it is difficult to see the material being cut.
 - e) **If you are approached by another person while operating the machine, switch the machine off.** There is an increased risk of injury to other persons being struck by the moving blade in the event of blade thrust.

www.stihl.com



0458-030-0101-A



0458-030-0101-A