

FSA 70.0 R

STIHL



2 - 24 Instruction Manual



Contents

1	Introduction.....	2
2	Guide to Using this Manual.....	2
3	Overview.....	3
4	Safety Precautions.....	4
5	Preparing Trimmer for Operation.....	11
6	Charging the Battery, LEDs.....	11
7	Assembling the Trimmer.....	12
8	Adjusting Trimmer for User.....	13
9	Removing and Fitting the Battery.....	13
10	Switching the Trimmer On/Off.....	14
11	Testing the Trimmer and Battery.....	14
12	Operating the Trimmer.....	14
13	After Finishing Work.....	15
14	Transporting.....	16
15	Storing.....	16
16	Cleaning.....	17
17	Maintenance.....	17
18	Repairing.....	17
19	Troubleshooting.....	17
20	Specifications.....	19
21	Combinations of Cutting Attachments and Deflectors.....	20
22	Spare Parts and Accessories.....	20
23	Disposal.....	20
24	EC Declaration of Conformity.....	20
25	Addresses.....	21
26	General Power Tool Safety Warnings.....	21

1 Introduction

Dear Customer,

Thank you for choosing STIHL. We develop and manufacture our quality products to meet our customers' requirements. The products are designed for reliability even under extreme conditions.

STIHL also stands for premium service quality. Our dealers guarantee competent advice and instruction as well as comprehensive service support.

STIHL expressly commit themselves to a sustainable and responsible handling of natural resources. This user manual is intended to help you use your STIHL product safely and in an environmentally friendly manner over a long service life.

We thank you for your confidence in us and hope you will enjoy working with your STIHL product.



Dr. Nikolas Stihl

IMPORTANT! READ BEFORE USING AND KEEP IN A SAFE PLACE FOR REFERENCE.

2 Guide to Using this Manual

2.1 Applicable Documentation

Local safety regulations apply.

- ▶ Read, understand and save the following documents in addition to this instruction manual:
 - Instruction manual and packaging of the cutting attachment you are using
 - Safety notices and precautions for STIHL AK battery.
 - Safety information for STIHL batteries and products with built-in batteries: www.stihl.com/safety-data-sheets

2.2 Symbols used with warnings in the text

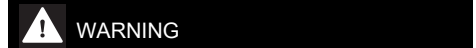

WARNING

- This symbol indicates dangers that can cause serious injuries or death.
 - ▶ The measures indicated can avoid serious injuries or death.



NOTICE

- This symbol indicates dangers that can cause damage to property.
 - ▶ The measures indicated can avoid damage to property.

2.3 Symbols in Text



This symbol refers to a chapter in this instruction manual.

3 Overview

3.1 Brushcutter, battery and charger

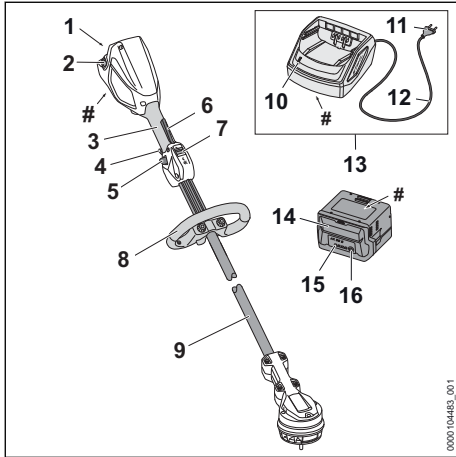

- 1 Battery compartment**
The battery compartment holds the battery.
- 2 Locking lever**
The locking lever holds the battery in the battery compartment.
- 3 Control handle**
The control handle is used for operating, holding and guiding the brushcutter.
- 4 Trigger**
Switches the brushcutter on and off.
- 5 Release slide**
The release slide releases the trigger.
- 6 Ergo lever**
The Ergo lever holds the release slide in position when the trigger is released.
- 7 Power setting switch**
The power setting switch is used to select the power level.
- 8 Loop handle**
For holding and controlling the brushcutter.
- 9 Shaft**
The shaft connects all components.
- 10 LED**
The LED indicates the status of the charger.
- 11 Mains plug**
The mains plug connects the connecting cable to a wall socket.

12 Connecting cable

The connecting cable connects the charger to the mains plug.

13 Charger

The charger charges the battery.

14 Battery

The battery supplies power to the brushcutter.

15 LEDs

The LEDs indicate the state of charge of the battery and any errors.

16 Button

The pushbutton activates the LEDs on the battery.

Rating plate with serial number

3.2 Deflector and cutting attachments

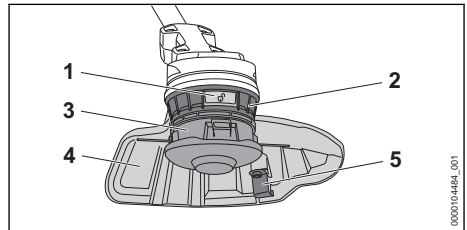

1 Release button

The release button disengages the mowing head.

2 Fanwheel

The fanwheel cools the electric motor.

3 Mowing head

The mowing head holds the mowing lines.

4 Deflector

Protects the user from flying debris and contact with the cutting attachment.

5 Line limiting blade

The line limiting blade trims mowing lines to the correct length.

3.3 Symbols

Meanings of symbols that may be on the brushcutter, battery and charger:



This symbol shows the maximum speed of the cutting attachment.



1 LED lights up red. The battery is too warm or too cold.



4 LEDs flash red. There is a fault in the battery.



The LED lights up green and the LEDs on the battery light up or flash green. The battery is charging.



The LED flashes red. There is no electrical contact between the battery and the charger, or there is a fault in the battery or in the charger.



Guaranteed sound power level in accordance with Directive 2000/14/EC in dB(A) for the purpose of comparing the sound emissions of products.



The information next to the symbol indicates the energy content of the battery according to the cell manufacturer's specification. The energy content available in operation is lower.



Operate the electrical device in an enclosed and dry space.



Do not dispose of the product with domestic waste.



Maximum power level.



ECO power level.

ECO

4 Safety Precautions

4.1 Warning symbols

Meanings of warning signs and labels on the brushcutter, battery and charger:



Observe safety notices and take the necessary precautions.



Read and understand the User Manual and keep it in a safe place for reference.



Wear safety glasses.



Observe the safety advice concerning flying objects and associated measures.



Remove the battery during work interruptions, transport, storage, maintenance or repair.



Protect the brushcutter and charger against rain and dampness.



Maintain a safe distance.



Do not use metal cutting attachments.



Protect the battery against heat and fire.



Protect the battery against rain and moisture and do not immerse it in liquids.

4.2 Intended Use

The STIHL FSA 70.0 R brushcutter is designed for mowing grass.

Never use the brushcutter in the rain.

The STIHL AK battery feeds the brushcutter with power.

The STIHL AL 101 charger is used to charge the STIHL AK battery.

⚠ WARNING

- There is a risk that batteries and chargers that are not explicitly approved by STIHL for the brushcutter can cause fire or explosion. Persons may be seriously or fatally injured, and property may be damaged.
 - ▶ Use the brushcutter with a STIHL AK battery.
 - ▶ Recharge the STIHL AK battery with a STIHL AL 101, AL 301 or AL 501 charger.
- Using the brushcutter, battery or charger for purposes for which they were not designed can cause material damage and serious or fatal injuries.
 - ▶ Use the brushcutter, battery and charger as described in this User Manual.

4.3 Requirements for the user

⚠ WARNING

- Users without adequate training or instruction cannot recognize or assess the risks involved in using the brushcutter, battery and charger. The user or other persons may sustain serious or fatal injuries.



- ▶ Read and understand the User Manual and keep it in a safe place for reference.
 - ▶ If you pass on the brushcutter, battery and charger to another person: Always give them the User Manual.
 - ▶ Make sure that the user meets the following conditions:
 - The user is rested.
 - The user must be physically, sensorially and mentally able to operate and work with the brushcutter, battery and charger. If the user is able to operate the equipment but has physical, sensory or mental limitations, the user may only work with the equipment under the supervision of or after receiving instruction from a responsible person.
 - The user is able to recognize and assess the risks involved in using the brushcutter, battery and charger.
 - The user is an adult or is being trained in an occupation under supervision according to national regulations.
 - The user has received instruction from a STIHL authorized dealer or other experienced user before working with the brushcutter or using the charger for the first time.
 - The user is not under the influence of alcohol, medication or drugs.
 - ▶ If you are unsure: Contact a STIHL authorized dealer.
- Inappropriate clothing can snag on wood, brush or the brushcutter. Users not wearing suitable clothing may be seriously injured.
 - ▶ Wear close-fitting clothing.
 - ▶ Remove scarves and jewelry.
 - The user may come into contact with the rotating cutting attachment during operation. This may result in serious injury to the user.
 - ▶ Wear robust footwear.
 - ▶ Wear long pants made of robust material.
 - There is a risk of the user coming into contact with the cutting attachment or the line limiting blade during cleaning and maintenance work and when the cutting attachment is mounted or removed. This may result in injury to the user.
 - ▶ Wear work gloves made of robust material.
 - Wearing unsuitable footwear may cause the user to slip. This may result in injury to the user.
 - ▶ Wear sturdy, closed-toed footwear with non-slip soles.

4.4 Clothing and equipment

▲ WARNING

- Objects can be thrown at high speed during operation. This may result in injury to the user.
 - ▶ Wear close-fitting safety glasses. Suitable safety glasses are tested in accordance with EN 166 or national regulations and available commercially with the corresponding marking.
- ▶ If your face may be injured during work, STIHL recommends wearing a face protection over the safety glasses.
- ▶ Wear long pants made of robust material.
- Dust may be whipped up during operation. Whipped up dust can damage the respiratory passages and cause allergic reactions.
 - ▶ If dust is generated: Wear a dust respirator mask.



4.5 Work Area and Surroundings

4.5.1 Brushcutter

▲ WARNING

- Bystanders, children and animals are not aware of the dangers of the brushcutter and objects being thrown into the air and cannot assess them. Bystanders, children and animals may be seriously injured and property may be damaged.
 - ▶ Keep bystanders, children and animals at a distance of 15 m from the working area.
- ▶ Maintain a distance of 15 m from objects.
- ▶ Do not leave the brushcutter unattended.
- ▶ Ensure that children cannot play with the brushcutter.
- The brushcutter is not waterproof. If you work in the rain or in a damp environment, an electric shock may occur. The user may be injured and the brushcutter may be damaged.
 - ▶ Do not work in the rain or in a damp environment.
- Electrical components of the brushcutter can produce sparks. Sparks can cause fires and explosions in a flammable or explosive environment. This can result in serious injuries or death and damage to property.
 - ▶ Do not work in a flammable environment or in an explosive environment.



4.5.2 Battery

▲ WARNING

- Bystanders, children and animals cannot recognize or assess the dangers of the battery. Bystanders, children and animals may be seriously injured.
 - ▶ Keep bystanders, children and animals away from the work area.
 - ▶ Do not leave the battery unattended.
 - ▶ Make sure that children cannot play with the battery.
- The battery is not protected against all ambient conditions. If the battery is exposed to certain ambient conditions, the battery may catch fire, explode or be irreparably damaged. This may result in serious injury to people and damage to property.



- ▶ Protect battery from heat and fire.
- ▶ Do not throw the battery into a fire.

- ▶ Do not charge, use and store the battery outside of the specified temperature limits,  20.5.



- ▶ Protect the battery from rain and moisture and do not immerse it in liquids.

- ▶ Keep battery away from small metal parts.
- ▶ Do not expose the battery to high pressure.
- ▶ Do not expose the battery to microwaves.
- ▶ Protect the battery from chemicals and salts.

4.5.3 Charger

▲ WARNING

- Bystanders and children are not aware of and cannot assess the dangers of a charger or electric current. Bystanders, children and animals may be seriously or fatally injured.
 - ▶ Keep bystanders, children and animals away from the work area.
 - ▶ Make sure that children cannot play with the charger.
- The charger is not waterproof. If you work in the rain or in a damp environment, an electric shock may occur. The user may be injured and the charger may be damaged.



- ▶ Do not operate it in the rain or in a damp environment.

- The charger is not protected against all ambient conditions. If the charger is exposed to certain ambient conditions, it may catch fire or

explode. This may result in serious injury to people and damage to property.

- ▶ Operate the charger in an enclosed, dry room.
- ▶ Do not operate the charger in a flammable environment or in an explosive environment.
- ▶ Do not operate the charger on a readily combustible surface.
- ▶ Do not use and store the charger outside of the specified temperature limits,  20.5.
- People may trip over the connecting cable. People may be injured and the charger may be damaged.
 - ▶ Lay the connecting cable flat on the floor.

4.6 Safe Condition

4.6.1 Brushcutter

The brushcutter is in a safe condition if the following points are observed:

- The brushcutter is not damaged.
- The brushcutter is clean and dry.
- The controls function properly and have not been modified.
- A combination of cutting attachment and deflector recommended in this user manual is mounted.
- The cutting attachment and deflector are properly mounted.
- Genuine STIHL accessories for this brushcutter are fitted.
- The accessories are correctly attached.

▲ WARNING

- If not in safe condition, components may no longer operate correctly and safety devices may be disabled. This may result in serious or fatal injury to people.
 - ▶ Work only with an undamaged brushcutter.
 - ▶ If the brushcutter is dirty or wet: Clean the brushcutter and allow it to dry.
 - ▶ Never attempt to modify your brushcutter. Exception: Mounting one of the combinations of cutting attachment and deflector recommended in this user manual.
 - ▶ If the controls do not function properly: Do not use your brushcutter.
 - ▶ Never mount metal cutting attachments.
 - ▶ Fit genuine STIHL accessories for this brushcutter.
 - ▶ Mount the cutting attachment and deflector as described in this user manual.
 - ▶ Attach accessories as described in this User Manual or in the User Manual for the accessories.

- ▶ Never insert objects in the openings of the brushcutter.
- ▶ Replace worn or damaged labels.
- ▶ If you have any doubts, be sure to consult a STIHL dealer.

4.6.2 Deflector

The deflector is in a safe condition if the following points are observed:

- The deflector is not damaged.
- The line limiter blade is correctly installed.

▲ WARNING

- If the product does not comply with safety requirements, components will no longer function properly or safety devices may be rendered inoperative. This can result in serious injuries.
 - ▶ Work only with an undamaged deflector.
 - ▶ Work with a correctly installed line limiter blade.
 - ▶ If you have any queries: Contact your STIHL servicing dealer.

4.6.3 Mowing head

The mowing head is in a safe condition if the following points are observed:

- The mowing head is not damaged.
- The mowing head is not jammed.
- The mowing head is attached correctly.
- The mowing lines are properly installed.
- If a Polycut mowing head with polymer blades is used:
 - The polymer blades are free of damage and tears.
 - The polymer blades are properly mounted.
- The wear limits are not exceeded.

▲ WARNING

- If they are in an unsafe condition, parts of the mowing head, mowing lines or polymer blades may come off and be ejected at high speed. People may suffer serious injuries as a result.
 - ▶ Work only with an undamaged mowing head.
 - ▶ If a PolyCut mowing head with polymer blades is used: Never work with damaged polymer blades.
 - ▶ Never use metal objects in place of the nylon mowing lines or polymer blades.
 - ▶ Note and comply with the wear limits.
 - ▶ If you are unsure: Contact a STIHL authorized dealer.

4.6.4 Battery

The battery is in a safe condition if the following points are observed:

- Battery is undamaged.
- The battery is clean and dry.
- Battery functions properly and has not been modified.

▲ WARNING

- A battery that is not in a safe condition cannot operate safely. Persons may be seriously injured.
 - ▶ Never work with a damaged battery.
 - ▶ Never attempt to charge a damaged or defective battery.
 - ▶ If the battery is dirty: Clean the battery.
 - ▶ If the battery is wet or damp: Allow the battery to dry, ☞ 20.6.
 - ▶ Never attempt to modify the battery.
 - ▶ Never insert objects in the battery's openings.
 - ▶ Never bridge the battery's contacts with metallic objects (short circuit).
 - ▶ Do not open the battery.
 - ▶ Replace worn or damaged labels.
- Fluid may leak from a damaged battery. If that liquid comes into contact with the skin or eyes, the skin or eyes may be irritated.
 - ▶ Avoid contact with the liquid.
 - ▶ If skin contact occurs: Wash affected areas of skin with plenty of water and soap.
 - ▶ In the event of contact with eyes: Rinse eyes with plenty of water for at least 15 minutes and consult a doctor.
- A damaged or defective battery may smell unusual, emit smoke or burn. Persons may be seriously or fatally injured, and property may be damaged.
 - ▶ If the battery smells unusual or emits smoke: do not use the battery and keep it away from combustible substances.
 - ▶ If the battery catches fire: Attempt to extinguish the battery with a fire extinguisher or water.

4.6.5 Charger

The charger is in a safe condition if the following points are observed:

- Charger is undamaged.
- Charger is clean and dry.

▲ WARNING

- If components do not comply with safety requirements, they will no longer function properly and safety devices may be rendered

inoperative. This can result in serious or fatal injuries.

- ▶ Do not use a damaged charger.
- ▶ If the charger is dirty or wet: Clean the charger and allow it to dry.
- ▶ Never attempt to modify the charger.
- ▶ Never insert objects in the charger's openings.
- ▶ Never bridge the charger's contacts with metallic objects (short circuit).
- ▶ Do not open the charger.

4.7 Working

▲ WARNING

- In certain situations, the user may no longer be able to concentrate on their work. This may result in the user stumbling, falling and suffering serious injury.
 - ▶ Work calmly and methodically.
 - ▶ If light and visibility are poor: Do not use your brushcutter.
 - ▶ Operate the brushcutter alone.
 - ▶ Keep the cutting attachment close to the ground and horizontal to the surface.
 - ▶ Watch out for obstacles.
 - ▶ Work standing on the ground and keep your balance.
 - ▶ If you start feeling fatigue: Take a break.
- The rotating cutting attachment can cut the user. This may result in serious injury to the user.
 - ▶ Do not touch the rotating cutting attachment.
 - ▶ If the cutting attachment is blocked by an object: Switch off the brushcutter and remove the battery. Only then remove the object.
- If the behavior of the brushcutter changes during operation or feels unusual, it may no longer be in a safe condition. This may result in serious injury to people and damage to property.
 - ▶ Stop working, remove the battery and contact a STIHL authorized dealer.
- Vibrations may occur while using the brushcutter.
 - ▶ Wear gloves.
 - ▶ Take breaks.
 - ▶ If signs of a circulatory disorder occur: Consult a doctor.
- If the cutting attachment makes contact with a foreign object during operation, the object or parts of it may be ejected at high speed. Persons may be injured or property may be damaged.

- ▶ Remove foreign objects from the working area.
- If the rotating cutting attachment makes contact with a hard object, sparks may occur and the cutting attachment may be damaged. Sparks can cause fires in a flammable environment. Persons may be seriously or fatally injured, and property may be damaged.
 - ▶ Do not use in a flammable environment.
 - ▶ Make sure the cutting attachment is in a safe condition.
- Note that the cutting attachment continues to rotate for a short period after you release the trigger. People may suffer serious injuries as a result.
 - ▶ Wait until the cutting attachment comes to a complete stop.

4.8 Charging

▲ WARNING

- A damaged or defective charger may produce an unusual smell or emit smoke during the charging process. This may result in personal injuries and damage to property.
 - ▶ Disconnect the plug from the wall outlet.
- The charger can overheat and cause a fire if heat dissipation is inadequate. This can result in serious or fatal injuries and damage to property.
 - ▶ Do not cover the charger.

4.9 Connecting to the power supply

Contact with live components may occur for the following reasons:

- The connecting cable or the extension cord is damaged.
- The mains plug of the connecting cable or extension cord is damaged.
- The socket is not properly installed.

▲ DANGER

- Contact with live parts may result in electric shock. This may result in serious or fatal injury to the user.
 - ▶ Make sure that the connecting cable, extension cord and their mains plugs are undamaged.



If the connecting cable or the extension cord is damaged:

- ▶ Do not touch the damaged area.
- ▶ Disconnect the mains plug from the power supply.

- ▶ Make sure your hands are dry before touching the connecting cable, extension cord or mains plugs.

- ▶ Plug the mains plug of the connecting cable or extension cord into a properly installed, shockproof socket with the correct fuse rating.
- ▶ Install the charger with a ground fault circuit interrupter (30 mA, 30 ms).
- A damaged or unsuitable extension cable can result in electric shock. There is a risk of serious or fatal injury.
 - ▶ Use an extension cable with the correct cable cross-section,  20.4.

WARNING

- Overvoltage can occur in the charger if the line voltage or frequency are incorrect during charging. The charger may be damaged.
 - ▶ Make sure that the mains voltage and the mains frequency of the power supply match the data on the rating plate of the charger.
- If the charger is connected to a power strip, electrical components may be overloaded during the charging process. The components may overheat and cause a fire. Persons may be seriously or fatally injured, and property may be damaged.
 - ▶ Ensure that the technical specifications for the power strip are not exceeded by the information on the rating plate of the charger and of all electrical devices connected to the power strip.
- An incorrectly routed connecting cable or extension cord may be damaged, and people may trip over it. People may be injured, and the connecting cable or extension cord may be damaged.
 - ▶ Route and mark the connecting cable and extension cord so that people will not trip over them.
 - ▶ Route the connecting cable and extension cord so that they are not under tension or tangled.
 - ▶ Route the connecting cable and extension cord so that they will not be damaged, kinked or crushed and will not be chafed.
 - ▶ Protect the connecting cable and extension cord from heat, oil and chemicals.
 - ▶ Lay the connecting cable and extension cord on a dry surface.
- The extension cable warms up in operation. If that heat cannot escape, it may cause a fire.
 - ▶ If using a cable reel: completely unroll the cable reel.
- If wiring and pipes are laid in the wall, they may be damaged if the charger is mounted on the wall. Contact with wiring can result in elec-

tric shock. This may result in serious injury to people and damage to property.

- ▶ Make sure there is no wiring or pipes in the wall at the proposed mounting site.
- If the charger is not mounted on the wall as described in this User Manual, the charger or the battery may fall or the charger may overheat. This may result in injury to people and damage to property.
 - ▶ Mount the charger on a wall as described in this User Manual.
- If the charger is mounted on a wall with the battery inserted, the battery may fall out of the charger. This may result in injury to people and damage to property.
 - ▶ Mount the charger on the wall first before inserting the battery.

4.10 Transporting

4.10.1 Trimmer

WARNING

- The trimmer may turn over or shift during transport. This may result in personal injuries and damage to property.



- ▶ Remove the battery.
- ▶ Secure the trimmer with lashing straps or a net to prevent it turning over and moving.

4.10.2 Battery

WARNING

- The battery is not protected against all ambient conditions. The battery may be damaged if it is exposed to certain ambient conditions, and damage to property may occur.
 - ▶ Never transport a damaged battery.
- The battery may turn over or shift during transport. This may result in injury to people and damage to property.
 - ▶ Pack the battery in packaging in such a way that it cannot move.
 - ▶ Secure the packaging so that it cannot move.

4.10.3 Charger

WARNING

- The charger may turn over or move while being transported. This may result in personal injuries and damage to property.
 - ▶ Disconnect the plug from the wall outlet.
 - ▶ Remove the battery.

- ▶ Secure the charger with lashing straps, belts or a net to prevent it turning over and moving.
- The connecting cable must not be used for carrying the charger. The connecting cable and the charger may be damaged.
 - ▶ Wind up the connecting cable and attach it to the charger.

4.11 Storing

4.11.1 Trimmer

▲ WARNING

- Children are not aware of and cannot assess the dangers of a trimmer and can be seriously injured.



- ▶ Remove the battery.

- ▶ Store the trimmer out of the reach of children.

- Dampness can corrode the electrical contacts on the trimmer and metal components. This can damage the trimmer.



- ▶ Remove the battery.

- ▶ Store the trimmer in a clean and dry condition.

4.11.2 Battery

▲ WARNING

- Children are not aware of and cannot assess the dangers of the battery. Children may be seriously injured.
 - ▶ Store the battery out of the reach of children.
- The battery is not protected against all ambient conditions. If the battery is exposed to certain ambient conditions, the battery may be irreparably damaged.
 - ▶ Store the battery in a clean and dry condition.
 - ▶ Store the battery in an enclosed space.
 - ▶ Store the battery separately from the brushcutter.
 - ▶ If the battery is stored in the charger, disconnect the mains plug and store the battery at a state of charge between 40% and 60% (2 lit green LEDs).
 - ▶ Do not store the battery outside of the specified temperature limits, 20.5.

4.11.3 Charger

▲ WARNING

- Children are not aware of and cannot assess the dangers of a charger. Children can be seriously injured or killed.
 - ▶ Disconnect the plug from the wall outlet.
 - ▶ Store the charger out of reach of children.
- The charger is not protected against all ambient conditions. If the charger is exposed to certain ambient conditions, the charger may be damaged.
 - ▶ Disconnect the plug from the wall outlet.
 - ▶ If the charger is hot: Allow the charger to cool down.
 - ▶ Store the charger in a clean, dry place.
 - ▶ Store the charger in an enclosed room.
 - ▶ Do not store the charger outside of the specified temperature limits, 20.5.
- The connecting cable should not be used for carrying the charger or hanging up the charger. The connecting cable and the charger may be damaged.
 - ▶ Hold the charger by the housing in a secure grip. The charger is provided with a handle recess to make it easy to pick up the charger.
 - ▶ Hang the charger on the wall mounting.

4.12 Cleaning, Maintenance and Repair

▲ WARNING

- The brushcutter may start up unintentionally if the battery is left in place during cleaning, maintenance or repair operations. This may result in serious injury to people and damage to property.



- ▶ Remove the battery.

- Aggressive cleaning agents, a water jet or pointed objects can damage the trimmer, deflector, cutting attachment, battery and the charger. If the trimmer, deflector, cutting attachment, battery or charger are not cleaned correctly, components may no longer function properly or safety devices may be rendered inoperative. They may cause serious injury to persons.
 - ▶ Clean the trimmer, deflector, cutting attachment, battery and charger as described in this instruction manual.
- If the trimmer, deflector, cutting attachment, battery and charger are not properly serviced

or repaired, components may no longer function properly or safety devices may be rendered inoperative. This may result in serious or fatal injury to people.

- ▶ Do not attempt to service or repair the trimmer, deflector, cutting attachment, battery or charger.
- ▶ If the trimmer, deflector, cutting attachment, battery or the charger require servicing or repairs: Contact your STIHL servicing dealer for assistance.

5 Preparing Trimmer for Operation

5.1 Preparing the brushcutter for operation

The following steps must be performed before commencing work:

- ▶ Ensure that the following components are in a safe condition:
 - Brushcutter, [11.2](#).
 - Deflector, [7.1](#).
 - Mowing head, [7.3.1](#).
 - Battery, [4.6.4](#).
 - Charger, [4.6.5](#).
- ▶ Check the battery, [11.2](#).
- ▶ Fully charge the battery, [6.2](#).
- ▶ Clean the brushcutter, [16.1](#).
- ▶ Attach the deflector, [7.1](#).
- ▶ Attach the loop handle, [7.2](#).
- ▶ Mount the mowing head, [7.3.1](#).
- ▶ Adjust the loop handle, [8.1](#).
- ▶ Check the controls, [11.1](#).
- ▶ If you cannot carry out these steps: Do not use your brushcutter and contact a STIHL authorized dealer instead.

6 Charging the Battery, LEDs

6.1 Mounting the charger on a wall

The charger can be mounted on a wall.

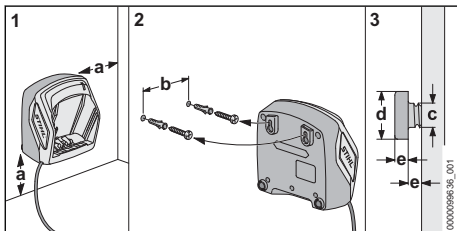

- ▶ Check the following points when mounting the charger on a wall:

- Use suitable mounting materials.
- The charger is level.
 - The following dimensions are observed:
 - a = at least 100 mm
 - b (for AL 101) = 75 mm
 - b (for AL 301, AL 501) = 100 mm
 - c = 4.5 mm
 - d = 9 mm
 - e = 2.5 mm

6.2 Charging the battery

The charging time depends on various factors, e.g. the battery temperature or the ambient temperature. For optimum performance, observe the recommended temperature ranges, [20.6](#). The actual charging time may vary from the charging time indicated. The charging time is indicated at www.stihl.com/charging-times.

The charging process starts automatically when the mains plug is plugged into a socket and the battery is inserted into the charger. The charger switches off automatically when the battery is fully charged.

The battery and the charger warm up during charging.

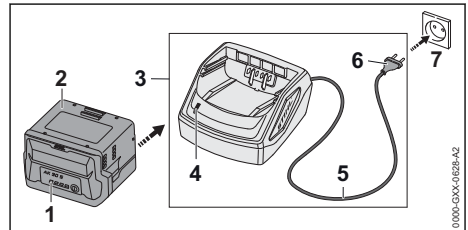

- ▶ Plug the mains plug (6) into an easily accessible socket (7).
 - The charger (3) will run a self-test. The LED (4) will glow green for about 1 second and red for about 1 second.
- ▶ Routing the connecting cord (5).
- ▶ Insert the battery (2) in the guides in the charger (3) and press it home as far as stop. The LED (4) glows green. The LEDs (1) glow green and the battery (2) is being charged.
- ▶ When the LED (4) and the LEDs (1) on the battery no longer light up: The battery (2) is fully charged and can be removed from the charger (3).
- ▶ If the charger (3) is no longer required: Disconnect the mains plug (6) from the wall outlet (7).

6.3 Displaying the state of charge

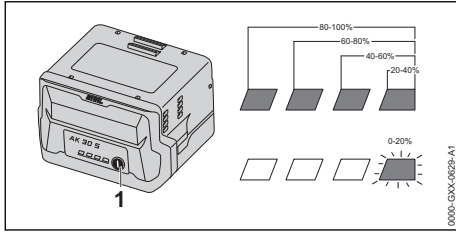

- ▶ Depress the pushbutton (1).
The LEDs light up green for about 5 seconds and indicate the state of charge.
- ▶ If the LED on the right flashes green: Charge the battery.

6.4 LEDs on Battery

The LEDs can show the state of charge or malfunctions. The LEDs can glow or flash green or red.

The state of charge is indicated when the LEDs glow or flash green.

- ▶ If the LEDs glow or flash red: Troubleshooting, 19.1.
Malfunction in trimmer or battery.

6.5 LED on Charger

The LED indicates the operating status of the charger.

If the LED glows green, the battery is being charged.

- ▶ If the LED flashes red: Rectify the malfunction.
Malfunction in charger.

7 Assembling the Trimmer

7.1 Attaching the deflector

- ▶ Switch off the brushcutter and remove the battery.

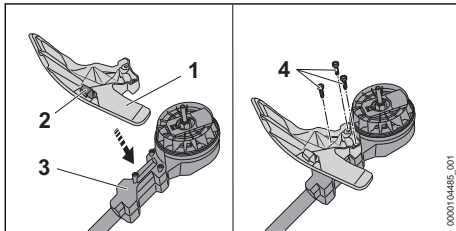

The line limiting blade (2) has already been installed in the deflector (1) and must not be removed.

- ▶ Fit the deflector (1) on the housing (3) and line up the holes.
- ▶ Insert screws (4) and tighten them.

The deflector (1) must not be removed.

7.2 Attaching the loop handle

- ▶ Switch off the brushcutter and remove the battery.

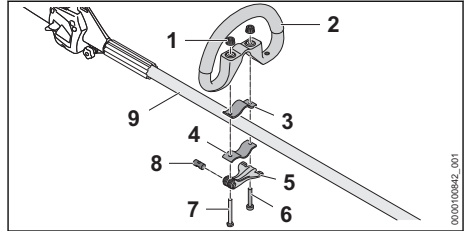

- ▶ Insert the pin (8) into the opening in the quick release clamp (5).
Align the pin (8) so that the notch of the pin is at the bottom.
- ▶ Place the clamp (3) in the loop handle so that the holes are aligned.
- ▶ Place the loop handle (2) with clamp (3) on the shaft (9).
- ▶ Insert the long screw (7) through the holes in the pin and quick release clamp (5).
- ▶ Press the clamp (4) against the shaft so that the holes are aligned.
- ▶ Insert the short screw (6) through the holes.
- ▶ Insert the long screw (7) through the holes.
- ▶ Screw on the knurled nuts (1).
- ▶ Close the quick release clamp (5).

The loop handle (2) is properly adjusted if it can no longer be moved.

- ▶ If the loop handle (2) can be moved:
 - ▶ Open the quick release clamp (5).
 - ▶ Tighten the knurled nuts (1).
 - ▶ Close the quick release clamp (5).
The loop handle (2) can no longer be moved.
- ▶ If the quick release clamp (5) cannot be closed:
 - ▶ Open the quick release clamp (5).
 - ▶ Loosen the knurled nuts (1).
 - ▶ Close the quick release clamp (5).
The loop handle (2) can no longer be moved.

7.3 Mounting and Removing the Mowing Head

7.3.1 Attaching the mowing head

- ▶ Switch off the brushcutter and remove the battery.

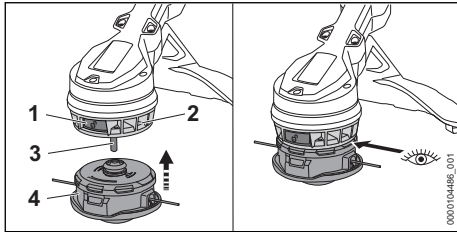

- ▶ If the release button (1) is not pressed: Press the release button (1) until it engages.
- ▶ Push the mowing head (2) onto the shaft (3) and press it against the fanwheel (2). The mowing head engages with a click. The release button pops out, and the mowing head fits flush against the fanwheel.
- ▶ If the mowing head does not engage: Press the mowing head against the fanwheel and rotate it until it engages.

7.3.2 Removing the mowing head

- ▶ Switch off the brushcutter and remove the battery.
- ▶ Hold the mowing head firmly with one hand.
- ▶ With the other hand, press the release button until it engages. The mowing head pops up from the shaft and can be removed.

8 Adjusting Trimmer for User

8.1 Adjusting and setting the loop handle

The loop handle can be set to different positions to suit the height and reach of the user.

- ▶ Switch off the brushcutter and remove the battery.

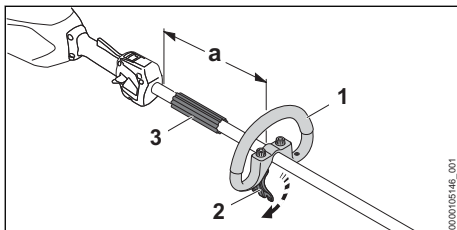

- ▶ Release the quick release clamp (2).

- ▶ Move the loop handle (1) to the required position and check that the following conditions are met:
 - The bump guard (3) fits between the loop handle (1) and the control handle.
 - The distance (a) of no more than 30 cm is not exceeded.
- ▶ Close the quick release clamp (2) so that the loop handle (1) cannot be rotated on the shaft any longer.

9 Removing and Fitting the Battery

9.1 Fitting the Battery

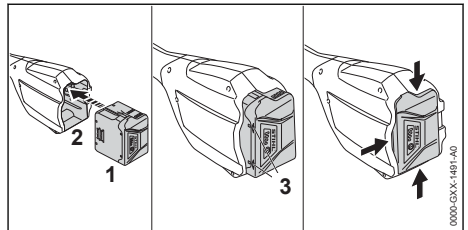

- ▶ Insert the battery (1) in the battery compartment (2) and press it home until you hear a click. Arrows (3) on battery (1) are still visible and battery (1) is held securely in battery compartment (2). There is no electrical contact between the trimmer and battery (1).
- ▶ Push the battery (1) into the battery compartment (2) as far as stop. The battery (1) engages with a second click and is flush with the trimmer's housing.

9.2 Removing the battery

- ▶ Keep one hand in front of the battery compartment so that the battery (2) cannot fall out.

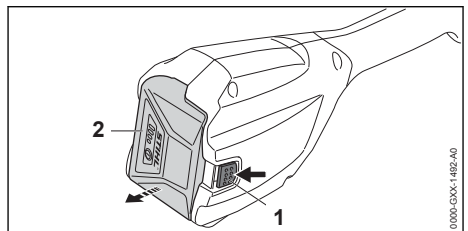

- ▶ Press and hold the locking lever (1) with your other hand. The battery (2) is now unlocked and can be removed.

10 Switching the Trimmer On/Off

10.1 Switching on the brushcutter

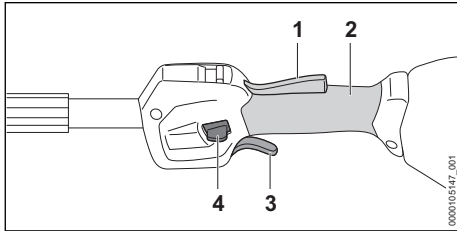

- ▶ Hold the brushcutter firmly with one hand on the control handle so that your thumb wraps around the grip (2) of the control handle.
- ▶ Hold the brushcutter firmly with your other hand on the loop handle so that your thumb wraps around the loop handle or the handle hose.
- ▶ Press the release slide (4) down with your thumb and hold it there.
- ▶ Press the trigger (3) with your index finger and keep it pressed.
The brushcutter accelerates and the cutting attachment rotates.
- ▶ You can now release the release slide (4).

If the ergo lever (1) is pressed, the trigger switch (3) remains unlocked. This means that the trigger can then be released and pressed again without having to push the release slide down again.

If the trigger (3) and the ergo lever (1) are released, the trigger (3) is locked. The release slide (4) must be pressed down again to unlock the trigger (3).

10.2 Switching off the brushcutter

- ▶ Release the trigger and the Ergo lever.
- ▶ Wait for the cutting attachment to stop rotating.
- ▶ If the cutting attachment continues to rotate: Remove the battery and contact your STIHL dealer.
The brushcutter is defective.

11 Testing the Trimmer and Battery

11.1 Checking the controls

Release slide, ergo lever and trigger

- ▶ Remove the battery.
- ▶ Try squeezing the trigger switch without activating the release slide.

- ▶ If you can press the trigger: Stop using your brushcutter and contact a STIHL authorized dealer.
The release slide is faulty.
- ▶ Press and hold the release slide.
- ▶ Press and hold the ergo lever.
- ▶ Press the trigger.
The release slide can be released.
- ▶ Release the trigger and ergo lever.
- ▶ If the release slide, trigger or ergo lever is stiff or does not spring back to the initial position: Stop using the brushcutter and contact a STIHL authorized dealer.
The release slide, trigger or ergo lever is defective.

Switching on the brushcutter

- ▶ Insert the battery.
- ▶ Press and hold the release slide.
- ▶ Press and hold the trigger.
The cutting attachment rotates.
- ▶ If 3 LEDs flash red: Remove the battery and consult a STIHL authorized dealer.
The brushcutter has a malfunction.
- ▶ Release the trigger.
The cutting attachment stops rotating after a short period of time.
- ▶ If the cutting attachment continues to rotate: Remove the battery and contact a STIHL authorized dealer.
The brushcutter is defective.

11.2 Testing the Battery

- ▶ Press button on battery.
The LEDs glow or flash.
- ▶ If the LEDs do not glow or flash: Do not use the battery and contact your STIHL servicing dealer.
There is a malfunction in the battery.

12 Operating the Trimmer

12.1 Holding and guiding the brushcutter

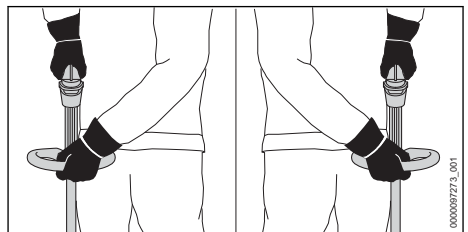



- ▶ Hold the brushcutter firmly with one hand on the control handle so that your thumb wraps around the grip of the control handle.
- ▶ Hold the brushcutter with the other hand on the loop handle so that your thumb wraps around the loop handle.

12.2 Setting the power level

Depending on the application, 2 power levels can be selected. The position of the power level slide (1) indicates the selected power level.

The selected power level affects the battery's runtime.

—  **ECO** : ECO power level, low speed

—  : Maximum power level, maximum speed

When you select the ECO power level, the speed is reduced.

This can extend the battery runtime.

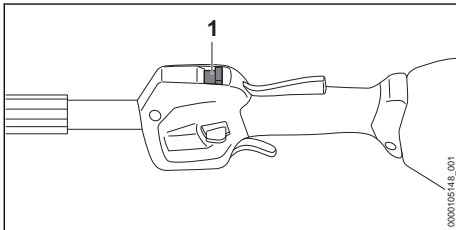

- ▶ Slide the power level slide (1) with your thumb to the selected position.

12.3 Mowing

The cutting height is determined by the distance of the cutting attachment from the ground.

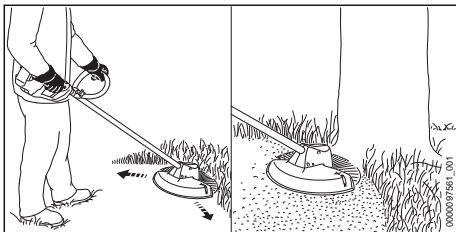

- ▶ Swing the brushcutter steadily back and forth in an arc.
- ▶ Walk forward slowly and steadily.

For optimal performance, note the recommended temperature ranges,  20.6.

12.4 Adjust the mowing lines on the AutoCut mowing heads

- ▶ Briefly tap the rotating mowing head on the ground.
About 30 mm of fresh nylon line is advanced. The line limiting blade in the deflector automatically cuts the mowing lines to the correct length.

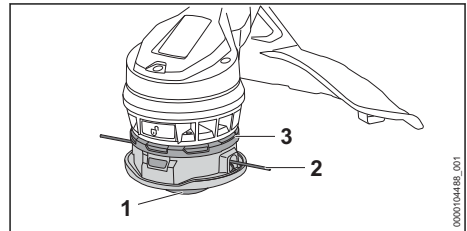

Automatic feed will not take place if the mowing lines are shorter than 25 mm.

- ▶ Switch off the brushcutter and remove the battery.
- ▶ Press the bottom part (1) in the direction of the top part (3) and keep it pressed.
- ▶ Pull out the mowing lines (2) by hand.
- ▶ If the mowing lines (2) cannot be pulled out to the required length: Replace the spool or the mowing lines (2).
The spool is empty.

If the mowing head is dirty under the top part (3), the mowing lines cannot be automatically adjusted.

- ▶ Remove the mowing head.
- ▶ Pull off the top (3) from the mowing head.
- ▶ Clean the area underneath the top (3).
- ▶ Push the top (3) onto the mowing head.
The top (3) engages with an audible click.

13 After Finishing Work

13.1 After Finishing Work

- ▶ Switch off the brushcutter and remove the battery.
- ▶ If the brushcutter is wet: Allow the brushcutter to dry.
- ▶ If the battery is moist or wet: Allow the battery to dry,  20.6.
- ▶ Clean the brushcutter.
- ▶ Clean the deflector.
- ▶ Clean the cutting attachment.
- ▶ Clean the battery.

14 Transporting

14.1 Transporting the brushcutter

- ▶ Switch off the brushcutter and remove the battery.

Carrying the Brushcutter

- ▶ Carry the brushcutter in one hand properly balanced by the shaft, with the cutting attachment behind you.

Transporting the brushcutter in the car

- ▶ Secure the brushcutter to prevent turnover and movement.

14.2 Transporting the Battery

- ▶ Switch off the brushcutter and remove the battery.
- ▶ Check that the battery is in a safe condition.
- ▶ Pack the battery in packaging in such a way that it cannot move inside the packaging.
- ▶ Secure the packaging so that it cannot move.

The battery is subject to the Carriage of Dangerous Goods regulations. The battery is classified as UN 3480 (lithium ion batteries) and has been tested pursuant to UN Manual Tests and Criteria Part III, Subsection 38.3.

The transport regulations can be found at www.stihl.com/safety-data-sheets.

14.3 Transporting the Charger

- ▶ Disconnect the plug from the wall outlet.
- ▶ Remove the battery.
- ▶ Wind up the connecting cable and attach it to the charger.
- ▶ Transporting the charger in a vehicle: Secure the charger with lashing straps, belts or a net to prevent it turning over and moving.

15 Storing

15.1 Storing the brushcutter

- ▶ Switch off the brushcutter and remove the battery.
- ▶ Ensure that the following conditions are met when storing the brushcutter:
 - The brushcutter cannot tip over or shift.
 - The brushcutter is out of the reach of children.
 - The brushcutter is clean and dry.
- ▶ If you store the brushcutter for more than 30 days: Remove the cutting attachment.

15.2 Storing the Battery

STIHL recommends keeping the battery in a charging state between 40% and 60 % (2 green LEDs lit).

- ▶ The battery should be stored in such a way that the following conditions are fulfilled:
 - The battery is out of the reach of children.
 - The battery is clean and dry.
 - The battery is in an enclosed space.
 - The battery is separated from the brushcutter.
 - If the battery is stored in the charger, disconnect the mains plug and store the battery at a state of charge between 40% and 60% (2 lit green LEDs).
 - Do not store the battery outside of the specified temperature limits, ☞ 20.5.

NOTICE

- If the battery is not stored as described in this User Manual, the battery may become deeply discharged and irreparably damaged.
 - ▶ Charge a discharged battery before storing it. STIHL recommends keeping the battery state of charge between 40% and 60% (2 lit green LEDs).
 - ▶ Store the battery separately from the brushcutter.

15.3 Storing the Charger

- ▶ Disconnect the mains plug from the power supply.

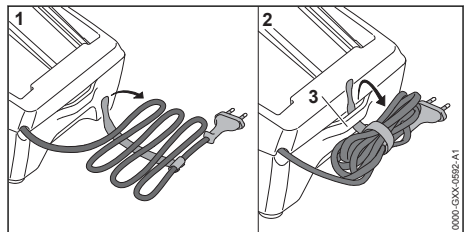

- ▶ Wind up the connecting cable and attach it to the charger.
- ▶ Observe the following points when storing the charger:
 - Charger is out of the reach of children.
 - The charger is clean and dry.
 - Charger is in an enclosed space.
 - The charger is not suspended from the connecting cable or the holder (3) for the connecting cable.
 - Do not store the charger outside of the specified temperature limits, ☞ 20.5.

16 Cleaning

16.1 Cleaning the Brushcutter

- ▶ Switch off the brushcutter and remove the battery.
- ▶ Clean the brushcutter with a damp cloth.
- ▶ Clean vents with a paintbrush.
- ▶ Remove foreign objects from the battery compartment and clean the battery compartment with a damp cloth.
- ▶ Clean the electrical contacts in the battery compartment with a paintbrush or soft brush.
- ▶ Clean the area underneath the fanwheel with a soft brush.

16.2 Cleaning the deflector and cutting attachment

- ▶ Switch off the brushcutter and remove the battery.
- ▶ Clean the deflector and cutting attachment with a damp cloth or a soft brush.

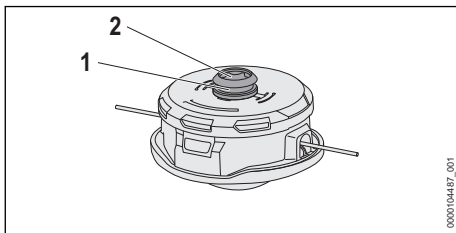

- ▶ Clean the groove (1) and mounting of the shaft (2) with a damp cloth or a soft brush.

16.3 Cleaning the Battery

- ▶ Clean the battery with a damp cloth.

16.4 Cleaning the Charger

- ▶ Disconnect the mains plug from the power supply.

- ▶ Clean the charger with a damp cloth.
- ▶ Clean vents with a paintbrush.
- ▶ Clean the charger's electrical contacts with a paintbrush or a soft brush.

17 Maintenance

17.1 Maintenance Intervals

The maintenance intervals are dependent on the environmental and operating conditions. STIHL recommends the following maintenance intervals:

Every 12 months

- ▶ Have the trimmer checked by a STIHL servicing dealer.

18 Repairing

18.1 Repairing the Trimmer, Battery and Charger

The trimmer, cutting attachment, battery and charger are not user serviceable.

- ▶ If the trimmer or cutting attachment is damaged: Do not use your trimmer or cutting attachment and contact your STIHL servicing dealer.
- ▶ If the battery has a malfunction or is damaged: Replace the battery.
- ▶ If the charger has a malfunction or is damaged: Replace the charger.
- ▶ If the connecting cable has a malfunction or is damaged: Do not use the charger and have connecting cable replaced by a STIHL servicing dealer.

19 Troubleshooting

19.1 Troubleshooting the brushcutter or battery

Error	LEDs on the battery	Cause	Remedy
The brushcutter does not start when switched on.	1 LED flashes green.	State of charge of the battery is too low.	▶ Charge the battery.
	1 LED lights up steady red.	The battery is too warm or too cold.	▶ Remove the battery. ▶ Allow the battery to cool down or warm up.
	3 LEDs flash red.	The brushcutter has a malfunction.	▶ Remove the battery. ▶ Clean the electrical contacts in the battery compartment. ▶ Insert the battery.

Error	LEDs on the battery	Cause	Remedy
			<ul style="list-style-type: none"> ▶ Switch on the brushcutter. ▶ If 3 LEDs continue to flash red: Do not use the brushcutter and contact a STIHL authorized dealer for assistance.
	3 LEDs light up red.	The brushcutter is too hot.	<ul style="list-style-type: none"> ▶ Remove the battery. ▶ Allow the brushcutter to cool down.
	4 LEDs flash red.	There is an error in the battery.	<ul style="list-style-type: none"> ▶ Remove the battery and reinsert it. ▶ Switch on the brushcutter. ▶ If 4 LEDs continue to flash red: Do not use the battery and contact a STIHL authorized dealer for assistance.
		No electrical contact between brushcutter and battery.	<ul style="list-style-type: none"> ▶ Remove the battery. ▶ Clean the electrical contacts in the battery compartment. ▶ Insert the battery.
		The brushcutter or battery is damp.	<ul style="list-style-type: none"> ▶ Allow the brushcutter or battery to dry,  20.6.
The brushcutter cuts out during operation.	3 LEDs light up red.	The brushcutter is too hot.	<ul style="list-style-type: none"> ▶ Remove the battery. ▶ Allow the brushcutter to cool down.
		There is an electrical error.	<ul style="list-style-type: none"> ▶ Remove the battery and reinsert it. ▶ Switch on the brushcutter.
The runtime of the brushcutter is too short.		The battery is not fully charged.	<ul style="list-style-type: none"> ▶ Fully charge the battery.
		The battery service life has been exceeded.	<ul style="list-style-type: none"> ▶ Replace the battery.
The power levels cannot be set.		The trigger is pressed and the brushcutter switched on.	<ul style="list-style-type: none"> ▶ Select the power level as described in this User Manual.
Mowing head cannot be attached.		The release button on the fanwheel is not pressed.	<ul style="list-style-type: none"> ▶ Press the release button. ▶ Attach the mowing head.
		The mowing head, shaft or fanwheel is dirty.	<ul style="list-style-type: none"> ▶ Clean the mowing head, shaft and fanwheel.
		The release button does not pop out and remains pushed in.	<ul style="list-style-type: none"> ▶ Clean the mowing head, shaft and fanwheel. ▶ If the release button remains pushed in: Contact a STIHL authorized dealer.
The mowing head cannot be removed even though the release button is pressed.		The mowing head, shaft or fanwheel is dirty.	<ul style="list-style-type: none"> ▶ Pull off the mowing head from the shaft. ▶ Clean the mowing head, shaft and fanwheel.
Charging does not start when the battery is inserted into the charger.	1 LED lights up steady red.	The battery is too warm or too cold.	<ul style="list-style-type: none"> ▶ Leave the battery inserted in charger. The charging starts automatically as soon as the permitted temperature range is reached.

19.2 Troubleshooting the Charger

Fault	LED on Charger	Cause	Remedy
Battery not being charged.	The LED flashes red.	No electrical contact between charger and battery.	<ul style="list-style-type: none"> ▶ Remove the battery. ▶ Clean contacts on charger. ▶ Insert battery.
		There is a malfunction in the charger.	<ul style="list-style-type: none"> ▶ Do not use the charger and contact your STIHL dealer for assistance.

19.3 Product Support and Assistance on Use

Product support and assistance on use are available from STIHL servicing dealers.

For contacts and other information, please visit <https://support.stihl.com> or www.stihl.com.

20 Specifications

20.1 STIHL FSA 70.0 R Brushcutter

- Approved battery: STIHL AK
- Weight with heaviest mowing head and associated heaviest deflector, without battery: 3.2 kg
- Length without cutting tool: 1660 mm
- Maximum speed of cutting attachment: 6500 rpm

For runtime, see www.stihl.com/battery-life.

20.2 STIHL AK Battery

- Battery technology: lithium-ion
- Voltage: 36 V
- Capacity in Ah: see rating label
- Energy content in Wh: see rating label
- Weight in kg: See rating label

20.3 STIHL AL 101 Charger

- Rated voltage: See rating plate
- Frequency: see rating plate
- Rated power: see rating plate
- Charging current: See rating plate

For charging times, see www.stihl.com/charging-times.

20.4 Extension Cords

If an extension cord is used, the cross sectional area of its conductors must meet the following minimum requirements – depending on the line voltage and length of the extension cord:

If rated voltage on the rating label is 220V to 240V:

- Cord length up to 20 m: AWG 15 / 1.5 mm²
- Cord length 20 m up to 50 m: AWG 13 / 2.5 mm²

If rated voltage on the rating label is 100V to 127V:

- Cord length up to 10 m: AWG 14 / 2.0 mm²
- Cord length 10 m up to 30 m: AWG 12 / 3.5 mm²

20.5 Temperature limits

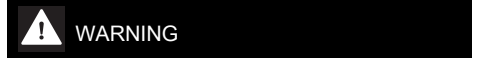

WARNING

- The battery is not protected against all ambient conditions. If the battery is exposed to certain environmental conditions, it may catch fire or explode. This may result in serious injury to people and damage to property.
 - ▶ Do not charge the battery below -20°C or above 50°C.
 - ▶ Do not use the brushcutter, battery or charger below - 20 °C or above + 50 °C.
 - ▶ Do not store the brushcutter, battery or charger below -20°C or above +70°C.

20.6 Recommended temperature ranges

For optimum performance of the brushcutter, battery and charger, observe the following temperature ranges:

- Charging: 5°C to 40°C
- Use: - 10 °C to + 40 °C
- Storage: - 20 °C to + 50 °C

If the battery is charged, used or stored outside the recommended temperature ranges, performance may be reduced.

If the battery is wet or moist, allow the battery to dry for at least 48 h between 15°C and 50°C and with less than 70% humidity. Higher humidity may extend the drying time.

20.7 Sound and vibration values

The K-value for the sound pressure level is 2 dB(A). The K value for the sound power level is 2 dB(A). The K value for the vibration level is 2 m/s².

STIHL recommends wearing hearing protection.

Use with a mowing head except PolyCut 12-2

- Sound pressure level L_{pA} measured in accordance with IEC 62841-4-4: 76 dB(A)
- Sound power level L_{WA} measured in accordance with IEC 62841-4-4: 91 dB(A)
- Vibration value a_{hv} measured in accordance with IEC 62841-4-4
 - Control handle: 2.0 m/s²
 - Loop handle: 4.9 m/s²

Use with a PolyCut 12-2 mowing head

- Sound pressure level L_{pA} measured in accordance with IEC 62841-4-4: 79 dB(A)
- Sound power level L_{WA} measured in accordance with IEC 62841-4-4: 91 dB(A)
- Vibration value a_{hv} measured in accordance with IEC 62841-4-4
 - Control handle: 2.0 m/s²
 - Loop handle: 3.8 m/s²

The sound and vibration values indicated were measured according to a standardized test method and can be used as a basis for comparing electric power tools. The actual sound and vibration levels may vary from the values indicated, depending on the type of application and the accessories used. The sound and vibration levels indicated can be used for an initial estimate of the sound and vibration load. The actual sound and vibration stress has to be estimated. The times can be taken into account in the estimate when the electric power tool is switched off and also when it is switched on but running without any load.

For information on compliance with the Physical Agents (Vibration) Directive 2002/44/EC, see www.stihl.com/vib.

20.8 REACH

REACH is an EC regulation and stands for the Registration, Evaluation, Authorisation and Restriction of Chemical substances.

For information on compliance with the REACH regulation see www.stihl.com/reach.

21 Combinations of Cutting Attachments and Deflectors**21.1 STIHL FSA 70 R Brushcutter**

The following mowing heads may be mounted with the deflector:

- STIHL AutoCut C 12-2 mowing head:

- with round, low-noise mowing line with a diameter of 2.0 mm or 2.4 mm
- PolyCut 12-2 mowing head
 - with orange blades (330 mm diameter)

22 Spare Parts and Accessories**22.1 Spare parts and accessories**

STIHL  These symbols indicate original STIHL spare parts and original STIHL accessories.

STIHL recommends the use of original STIHL spare parts and accessories.

Despite ongoing market observation, STIHL is unable to judge the reliability, safety and suitability of other manufacturers' spare parts and accessories; accordingly, STIHL cannot warrant for the use of those parts.

Original STIHL spare parts and original STIHL accessories are available from STIHL dealers.

23 Disposal**23.1 Disposal of Brushcutter, Battery and Charger**

Contact the local authorities or your STIHL dealer for information on disposal.

Improper disposal can be harmful to health and pollute the environment.

- ▶ Take STIHL products including packaging to a suitable collection point for recycling in accordance with local regulations.
- ▶ Do not dispose with domestic waste.

24 EC Declaration of Conformity**24.1 STIHL FSA 70.0 R Brushcutter**

ANDREAS STIHL AG & Co. KG

Badstraße 115

D-71336 Waiblingen

Germany

declares under our sole responsibility that

- Designation: Cordless brushcutter
- Machine category: Grass trimmer
- Manufacturer's brand: STIHL
- Model: FSA 70.0 R
- Serial number: FA07

conforms to the relevant provisions of Directives 2011/65/EU, 2006/42/EC and 2014/30/EU and

has been developed and manufactured in compliance with the following standards in the versions valid on the date of production: EN 55014-1, EN 55014-2, EN 62841-1 and ISO 12100, taking into consideration IEC 62841-4-4, EN 60335-1 and EN 50636-2-91.

The measured and guaranteed sound power levels were determined according to Directive 2000/14/EC, Annex VI.

Participating notified body: VDE Prüf- u. Zertifizierungsinstitut (NB 0366), Merianstraße 28, 63069 Offenbach, Germany
 – Measured sound power level: 91 dB(A)
 – Guaranteed sound power level: 93 dB(A)

The technical documents are stored at ANDREAS STIHL AG & Co. KG Produktzulassung.

The year of manufacture, country of manufacture and machine number are specified on the rating plate of the brushcutter.

Waiblingen, 2024-07-23

ANDREAS STIHL AG & Co. KG

pp 

Robert Olma, Vice President, Regulatory Affairs & Global Governmental Relations

25 Addresses

www.stihl.com

26 General Power Tool Safety Warnings

26.1 Introduction

This chapter reproduces the pre-formulated, general safety precautions specified in the IEC 62841 standard for hand-held motor-operated electric tools.

STIHL is obliged to publish these texts.

The safety precautions and warnings on avoiding an electric shock given under "Electrical Safety" do not apply to STIHL cordless products.

WARNING

- **Read all safety warnings, instructions, illustrations and specifications provided with this power tool.** Failure to follow all instructions listed below may result in electric shock, fire and/or serious injury. **Save all warnings and instructions for future reference.**

The term "electric power tool" in the safety warnings refers to mains-operated (corded) power tools or battery-operated (cordless) power tools.

26.2 Work area safety

- a) **Keep work area clean and well lit.** Cluttered or dark areas invite accidents.
- b) **Do not operate power tools in explosive atmospheres, such as in the presence of flammable liquids, gases or dust.** Power tools create sparks which may ignite the dust or fumes.
- c) **Keep children and bystanders away while operating a power tool.** Distractions can cause you to lose control.

26.3 Electrical safety

- a) **Power tool plugs must match the outlet. Never modify the plug in any way. Do not use any adapter plugs with earthed (grounded) power tools.** Unmodified plugs and matching outlets will reduce risk of electric shock.
- b) **Avoid body contact with earthed or grounded surfaces, such as pipes, radiators, ranges and refrigerators.** There is an increased risk of electric shock if your body is earthed or grounded.
- c) **Do not expose power tools to rain or wet conditions.** Water entering a power tool will increase the risk of electric shock.
- d) **Do not abuse the cord. Never use the cord for carrying, pulling or unplugging the power tool. Keep cord away from heat, oil, sharp edges or moving parts.** Damaged or entangled cords increase the risk of electric shock.
- e) **When operating a power tool outdoors, use an extension cord suitable for outdoor use.** Use of a cord suitable for outdoor use reduces the risk of electric shock.
- f) **If operating a power tool in a damp location is unavoidable, use a residual current device (RCD) protected supply.** Use of an RCD reduces the risk of electric shock.

26.4 Personal safety

- a) **Stay alert, watch what you are doing and use common sense when operating a power tool. Do not use a power tool while you are tired or under the influence of drugs, alcohol or medication.** A moment of inattention while operating power tools may result in serious personal injury.
- b) **Use personal protective equipment. Always wear eye protection.** Protective equipment such as a dust mask, non-skid safety shoes, hard hat or hearing protection used for appropriate conditions will reduce personal injuries.
- c) **Prevent unintentional starting. Ensure the switch is in the off-position before connecting to power source and/or battery pack, picking up or carrying the tool.** Carrying power tools with your finger on the switch or energising power tools that have the switch on invites accidents.
- d) **Remove any adjusting key or wrench before turning the power tool on.** A wrench or a key left attached to a rotating part of the power tool may result in personal injury.
- e) **Do not overreach. Keep proper footing and balance at all times.** This enables better control of the power tool in unexpected situations.
- f) **Dress properly. Do not wear loose clothing or jewellery. Keep your hair and clothing away from moving parts.** Loose clothes, jewellery or long hair can be caught in moving parts.
- g) **If devices are provided for the connection of dust extraction and collection facilities, ensure these are connected and properly used.** Use of dust collection can reduce dust-related hazards.
- h) **Do not let familiarity gained from frequent use of tools allow you to become complacent and ignore tool safety principles.** A careless action can cause severe injury within a fraction of a second.

26.5 Power tool use and care

- a) **Do not force the power tool. Use the correct power tool for your application.** The correct power tool will do the job better and safer at the rate for which it was designed.
- b) **Do not use the power tool if the switch does not turn it on and off.** Any power tool that cannot be controlled with the switch is dangerous and must be repaired.

- c) **Disconnect the plug from the power source and/or remove the battery pack, if detachable, from the power tool before making any adjustments, changing accessories, or storing power tools.** Such preventive safety measures reduce the risk of starting the power tool accidentally.
- d) **Store idle power tools out of the reach of children and do not allow persons unfamiliar with the power tool or these instructions to operate the power tool.** Power tools are dangerous in the hands of untrained users.
- e) **Maintain power tools and accessories. Check for misalignment or binding of moving parts, breakage of parts and any other condition that may affect the power tool's operation. If damaged, have the power tool repaired before use.** Many accidents are caused by poorly maintained power tools.
- f) **Keep cutting tools sharp and clean.** Properly maintained cutting tools with sharp cutting edges are less likely to bind and are easier to control.
- g) **Use the power tool, accessories and tool bits etc. in accordance with these instructions, taking into account the working conditions and the work to be performed.** Use of the power tool for operations different from those intended could result in a hazardous situation.
- h) **Keep handles and grasping surfaces dry, clean and free from oil and grease.** Slippery handles and grasping surfaces do not allow for safe handling and control of the tool in unexpected situations.

26.6 Battery tool use and care

- a) **Recharge only with the charger specified by the manufacturer.** A charger that is suitable for one type of battery pack may create a risk of fire when used with another battery pack.
- b) **Use power tools only with specifically designed battery packs.** Use of any other battery packs may create a risk of injury and fire.
- c) **When battery pack is not in use, keep it away from other metal objects, like paper clips, coins, keys, nails, screws or other small metal objects, that can make a connection from one terminal to another.** Shorting the battery terminals together may cause burns or a fire.
- d) **Under abusive conditions, liquid may be ejected from the battery; avoid contact. If**

- contact accidentally occurs, flush with water. If liquid contacts eyes, additionally seek medical help.** Liquid ejected from the battery may cause irritation or burns.
- e) **Do not use a battery pack or tool that is damaged or modified.** Damaged or modified batteries may exhibit unpredictable behaviour resulting in fire, explosion or risk of injury.
 - f) **Do not expose a battery pack or tool to fire or excessive temperature.** Exposure to fire or temperature above 130 °C may cause explosion.
 - g) **Follow all charging instructions and do not charge the battery pack or tool outside the temperature range specified in the instructions.** Charging improperly or at temperatures outside the specified range may damage the battery and increase the risk of fire.

26.7 Service

- a) **Have your power tool serviced by a qualified repair person using only identical replacement parts.** This will ensure that the safety of the power tool is maintained.
- b) **Never service damaged battery packs.** Service of battery packs should only be performed by the manufacturer or authorized service providers.

26.8 Grass Trimmer, Brush Cutter and Brush Saw Safety Warnings

- a) **Do not use the machine in bad weather conditions, especially when there is a risk of lightning.** This increases the risk of being struck by lightning.
- b) **Thoroughly inspect the area for wildlife where the machine is to be used.** Wildlife may be injured by the machine during operation.
- c) **Thoroughly inspect the area where the machine is to be used and remove all stones, sticks, wires, bones, and other foreign objects.** Thrown objects can cause personal injury.
- d) **Before using the machine, always visually inspect to see that the cutter or blade and the cutter or blade assembly are not damaged.** Damaged parts increase the risk of injury.
- e) **Follow instructions for changing accessories.** Improperly tightened blade security nuts or

bolts may either damage the blade or result in it becoming detached.

- f) **The rated rotational speed of the blade must be at least equal to the maximum rotational speed marked on the machine.** Blades running faster than their rated rotational speed can break and fly apart.
- g) **Wear eye, ear, head and hand protection.** Adequate protective equipment will reduce personal injury by flying debris or accidental contact with the cutting line or blade.
- h) **While operating the machine, always wear non-slip and protective footwear. Do not operate the machine when barefoot or wearing open sandals.** This reduces the chance of injury to the feet from contact with the moving cutters or lines.
- i) **While operating the machine, always wear safety footwear. Do not operate the machine when barefoot or wearing open sandals.** This reduces the chance of injury to the feet from contact with a moving cutter, line or blade.
- j) **While operating the machine, always wear long trousers.** Exposed skin increases the likelihood of injury from thrown objects.
- k) **Keep bystanders away while operating the machine.** Thrown debris can result in serious personal injury.
- l) **Always use two hands when operating the machine.** Holding the machine with both hands will avoid loss of control.
- m) **Hold the machine by insulated gripping surfaces only, because the cutting line or blade may contact hidden wiring or its own cord.** Cutting line or blades contacting a "live" wire may make exposed metal parts of the machine "live" and could give the operator an electric shock.
- n) **Always keep proper footing and operate the machine only when standing on the ground.** Slippery or unstable surfaces may cause a loss of balance or control of the machine.
- o) **Do not operate the machine on excessively steep slopes.** This reduces the risk of loss of control, slipping and falling which may result in personal injury.
- p) **When working on slopes, always be sure of your footing, always work across the face of slopes, never up or down and exercise extreme caution when changing direction.** This reduces the risk of loss of control, slip-

- ping and falling which may result in personal injury.
- q) **Keep all parts of the body away from the cutter, line or blade when the machine is operating. Before you start the machine, make sure the cutter, line or blade is not contacting anything.** A moment of inattention while operating the machine may result in injury to yourself or others.
 - r) **Do not operate the machine above waist height.** This helps prevent unintended cutter or blade contact and enables better control of the machine in unexpected situations.
 - s) **When cutting brush or saplings that are under tension, be alert for spring back.** When the tension in the wood fibres is released, the brush or sapling may strike the operator and/or throw the machine out of control.
 - t) **Use extreme caution when cutting brush and saplings.** The slender material may catch the blade and be whipped toward you or pull you off balance.
 - u) **Maintain control of the machine and do not touch cutters, lines or blades and other hazardous moving parts while they are still in motion.** This reduces the risk of injury from moving parts.
 - v) **Carry the machine with the machine switched off and away from your body.** Proper handling of the machine will reduce the likelihood of accidental contact with a moving cutter, line or blade.
 - w) **When transporting or storing the machine, always fit the cover on metal blades.** Proper handling of the machine will reduce the likelihood of accidental contact with the blade.
 - x) **Only use replacement cutters, lines, cutting heads and blades specified by the manufacturer.** Incorrect replacement parts may increase the risk of breakage and injury.
 - y) **When clearing jammed material or servicing the machine, make sure the switch is off and the battery pack is removed.** Unexpected starting of the machine while clearing jammed material or servicing may result in serious personal injury.

www.stihl.com



0458-063-0101-A



0458-063-0101-A