

GTA 40.0

STIHL



2 - 28 Instruction Manual



Contents

1	Guide to Using this Manual.....	2
2	Overview.....	2
3	Safety Precautions.....	4
4	Preparing Garden Pruner for Operation.....	13
5	Charging the Battery, LEDs.....	13
6	Assembling the Garden Pruner.....	14
7	Removing and Fitting the Battery.....	16
8	Switching On and Off.....	16
9	Checking the Garden Pruner and Battery.....	17
10	Using the Garden Pruner.....	18
11	After Finishing Work.....	19
12	Transporting.....	19
13	Storing.....	20
14	Cleaning.....	20
15	Maintenance.....	21
16	Repairing.....	21
17	Troubleshooting.....	22
18	Specifications.....	24
19	Bar and Chain Combinations.....	25
20	Spare Parts and Accessories.....	25
21	Disposal.....	25
22	EU conformity.....	25
23	Addresses.....	25
24	General Power Tool Safety Warnings.....	26

IMPORTANT! READ AND UNDERSTAND BEFORE USING AND KEEP IN A SAFE PLACE FOR REFERENCE.

1 Guide to Using this Manual

1.1 Applicable Documentation

Local safety regulations apply.

- ▶ Read, understand and save the following documents in addition to this instruction manual:
 - Safety information for STIHL batteries and products with built in batteries:
www.stihl.com/safety-data-sheets

1.2 Warning Notices in Text

! **DANGER**

- This notice refers to risks which result in serious or fatal injury.
 - ▶ Serious or fatal injuries can be avoided by taking the precautions mentioned.

! **WARNING**

- This notice refers to risks which **can** result in serious or fatal injury.
 - ▶ Serious or fatal injuries can be avoided by taking the precautions mentioned.

NOTICE

- This notice refers to risks which can result in damage to property.
 - ▶ Damage to property can be avoided by taking the precautions mentioned.

1.3 Symbols in Text

-  This symbol refers to a chapter in this instruction manual.

2 Overview

2.1 Garden pruner, battery and charger

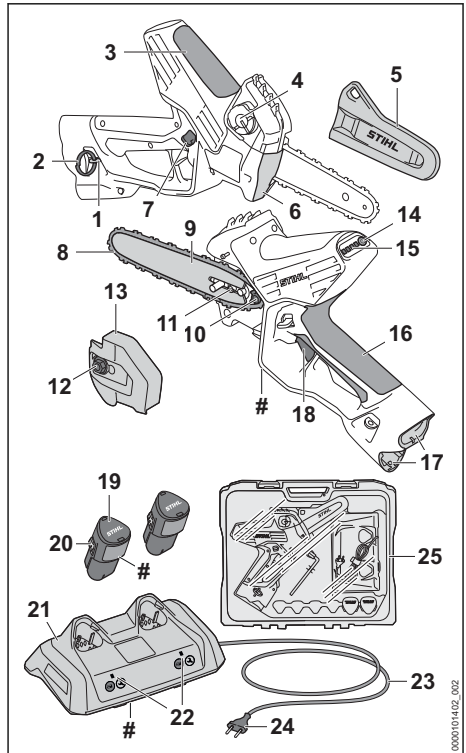

1 Ring

The ring is for attaching the overload ring.

2 Overload ring

The overload ring is used for hanging the garden pruner while working in a tree.

3 Grip

The grip is used for holding and controlling the garden pruner.

4 Oil tank cap

The oil tank cap closes the oil tank.

5 Chain scabbard

The chain scabbard protects against contact with the saw chain.

6 Limit stop

Supports the garden pruner against wood while cutting.

7 Locking lever

Unlocks the trigger.

8 Saw chain

The saw chain cuts the wood.

9 Guide bar

The guide bar supports and guides the saw chain.

10 Chain sprocket

The chain sprocket drives the saw chain.

11 Tensioning screw

The tensioning screw is used to adjust the chain tension.

12 Nut

The nut secures the chain sprocket cover to the garden pruner.

13 Chain sprocket cover

Covers the chain sprocket cover and secures the guide bar to the garden pruner.

14 Pushbutton

The pushbutton activates the LEDs on the garden pruner.

15 LEDs

The LEDs indicate the state of charge of the battery with the lowest charging status and any errors.

16 Control handle

For operating, holding and controlling the garden pruner.

17 Battery compartment

The battery compartment holds the battery.

18 Trigger

The trigger switches the garden pruner on and off.

19 Battery

Supplies power to the garden pruner.

20 Locking hook

Holds the battery in the battery compartment.

21 Charger

The charger charges the battery.

22 LED

The LED indicates the status of the charger.

23 Connecting cable

The connecting cable connects the charger to the mains plug.

24 Mains plug

The mains plug connects the connecting cable to a wall socket.

25 Case

The case is used for transporting and storing the garden pruner, battery, charger and accessories. The case only comes with the set (consisting of the garden pruner, battery, charger and accessories).

Rating plate with machine number**2.2 Symbols**

Meanings of the symbols that may be on the garden pruner, battery, charger and the case:



This symbol shows the direction of rotation of the saw chain.



Turn in this direction to tension the saw chain.



This symbol marks the oil tank for saw chain oil.



The LED lights up or flashes green. The battery is charging.



The LED flashes red. There is no electrical contact between the battery and the charger, or there is a fault in the battery or charger.



The symbol in the case indicates the recommended positioning of a fully charged battery.



The symbol in the case indicates the recommended positioning of a charged battery.



Length of guide bar that may be used.



Guaranteed sound power level in accordance with Directive 2000/14/EC in dB(A) for the purpose of comparing the sound emissions of products.



The information next to the symbol indicates the energy content of the battery according to the cell manufacturer's specification. The energy content available in operation is lower.



Operate the electric product in a dry place, indoors only.

 Do not dispose of the product with your household waste.

 Read and understand the User Manual and keep it in a safe place for reference.

3 Safety Precautions

3.1 Warning Signs

3.1.1 Warning symbols

Meanings of the warning symbols on the garden pruner:

 Follow the safety instructions and take the necessary precautions.

 Read and understand the User Manual and keep it in a safe place for reference.

 Wear safety glasses.

 Hold the garden pruner firmly with both hands.

 Do not touch the moving saw chain.

 Only suitably trained users are permitted to use this garden pruner while climbing in a tree.

 Remove the battery during work interruptions, transport, storage, maintenance or repair.

3.1.2 Battery

Meaning of warning symbols on the battery:

 Observe safety notices and take the necessary precautions.

 Read and understand the User Manual and keep it in a safe place for reference.

 Protect the battery against heat and fire.

 Do not immerse the battery in liquids.

3.1.3 Charger

Meanings of the warning signs on the charger:

 Observe safety notices and take the necessary precautions.

 Read and understand the User Manual and keep it in a safe place for reference.

 Protect the charger from rain and dampness.

3.2 Intended Use

The STIHL GTA 40.0 garden pruner is for cutting wood, tree care and for sawing in the crown of a standing tree.

The garden pruner can be used in the rain.

The ring with attached overload ring is used for securing the garden pruner with a sling and for transporting the garden pruner into a tree on a belt or rope.

Two STIHL AS batteries supply power to the garden pruner.

The STIHL AL 5-2 charger recharges STIHL AS batteries.

WARNING

- Batteries and chargers not approved by STIHL for the garden pruner may cause a fire or explosion. Persons may be seriously or fatally injured, and property may be damaged.
 - ▶ Use the garden pruner with two STIHL AS batteries.
 - ▶ Use a STIHL AL 1, AL 5 or AL 5-2 charger to recharge STIHL AS batteries.
- Using the garden pruner, battery or the charger for purposes for which they were not designed may result in serious or fatal injuries, and damage to property may occur.
 - ▶ Use the garden pruner, battery and charger as described in this User Manual.

3.3 Requirements for users

▲ WARNING

- Users without adequate training or instruction cannot recognize or assess the risks involved in using the garden pruner, battery and charger. The user or other persons may sustain serious or fatal injuries.



- ▶ Read and understand the User Manual and keep it in a safe place for reference.



- ▶ Only suitably trained users are permitted to use this garden pruner while climbing in a tree.

- ▶ If you pass on the garden pruner, battery or charger to another person: Always give them the User Manual.
- ▶ Make sure that the user meets the following conditions:
 - The user is rested.
 - The user is physically and mentally capable of operating and working with the garden pruner, battery and charger. If the user is able to operate the equipment but is physically, sensory or mentally impaired, the user may only work with the equipment under the supervision of or after receiving instruction from a responsible person.
 - The user is able to recognize and assess the risks involved in using the garden pruner, battery and charger.
 - The user is an adult or is being trained in an occupation under supervision according to national regulations.
 - The user has received instruction from a STIHL authorized dealer or other experienced user before working with the garden pruner and the charger for the first time.
 - The user is not under the influence of alcohol, medication or drugs.
- ▶ If you are unsure: Contact a STIHL authorized dealer.

3.4 Clothing and equipment

▲ WARNING

- Long hair can be pulled into the garden pruner during operation. This may result in serious injury to the user.

- ▶ Tie up and secure long hair above your shoulders.
- Objects can be thrown at high speed during operation. This may result in injury to the user.
 - ▶ Wear close-fitting safety glasses. Suitable protective glasses tested in accordance with European standard EN 166, EN ISO 16321 or in accordance with national standards and bearing the corresponding label are available from retailers.
- ▶ While working in a tree: STIHL recommends wearing face protection.
- ▶ Wear long trousers.
- ▶ When working in a tree: Wear a long-sleeved, close fitting top.
- Falling objects may cause head injuries.
 - ▶ If objects are likely to fall while working: Wear a hard hat.
- Dust may be whipped up during operation. Whipped up dust can damage the respiratory passages and cause allergic reactions.
 - ▶ If dust is generated: Wear a dust respirator mask.
- Inappropriate clothing can snag on wood, brush or the garden pruner. Not wearing suitable clothing may result in serious injury.
 - ▶ Wear close-fitting clothing.
 - ▶ Remove scarves and jewelry.
- When working in a tree, the user may come into contact with the moving saw chain while working. This may result in serious injury to the user.
 - ▶ Wear long trousers with cut-retardant inserts and cut-retardant sleeves on both arms.
- The user may cut himself or herself on wood while working. The user may come into contact with the saw chain during cleaning or servicing. This may result in injury to the user.
 - ▶ Wear work gloves made of robust material.
- Wearing unsuitable footwear may cause the user to slip. This may result in injury to the user.
 - ▶ Wear sturdy, closed-toed footwear with non-slip soles.
 - ▶ When working in a tree: Wear chainsaw boots with cut protection.
- When working in a tree there is risk of the user falling down. This may result in serious or fatal injury to the user.
 - ▶ Wear tear-resistant personal fall protection equipment.



3.5 Work Area and Surroundings

3.5.1 Garden pruner

WARNING

- Innocent bystanders, children and animals are not aware of the dangers of the garden pruner or flying debris. This may result in serious injury to bystanders, children and animals and damage to property.
 - ▶ Keep bystanders, children and animals away from the working area.
 - ▶ Do not leave the garden pruner unattended.
 - ▶ Make sure that children cannot play with the garden pruner.
- Electrical components of the garden pruner can produce sparks. Sparks may cause fires and explosions in highly flammable or explosive environments. Persons may be seriously or fatally injured, and property may be damaged.
 - ▶ Do not work in a highly flammable or explosive environment.

3.5.2 Battery

WARNING

- Bystanders, children and animals cannot recognize or assess the dangers of the battery. Bystanders, children and animals may be seriously injured.
 - ▶ Keep bystanders, children and animals away from the work area.
 - ▶ Do not leave the battery unattended.
 - ▶ Make sure that children cannot play with the battery.
- The battery is not protected against all ambient conditions. If the battery is exposed to certain ambient conditions, the battery may catch fire, explode or be irreparably damaged. This may result in serious injury to people and damage to property.



- ▶ Protect battery from heat and fire.
- ▶ Do not throw the battery into a fire.

- ▶ Do not charge, use and store the battery outside of the specified temperature limits,  18.7.



- ▶ Do not immerse the battery in liquids.

- ▶ Keep battery away from small metal parts.
- ▶ Do not expose the battery to high pressure.
- ▶ Do not expose the battery to microwaves.

- ▶ Protect the battery against chemicals, salts and fertilizers.

3.5.3 Charger

WARNING

- Bystanders and children are not aware of and cannot assess the dangers of a charger or electric current. Bystanders, children and animals may be seriously or fatally injured.
 - ▶ Keep bystanders, children and animals away from the work area.
 - ▶ Make sure that children cannot play with the charger.
- The charger is not waterproof. If you work in the rain or in a damp environment, an electric shock may occur. The user may be injured and the charger may be damaged.
 - ▶ Do not operate it in the rain or in a damp environment.



- The charger is not protected against all ambient conditions. If the charger is exposed to certain ambient conditions, it may catch fire or explode. This may result in serious injury to people and damage to property.
 - ▶ Operate the charger in an enclosed, dry room.
 - ▶ Do not operate the charger in a flammable environment or in an explosive environment.
 - ▶ Do not operate the charger on a readily combustible surface.
 - ▶ Do not use and store the charger outside of the specified temperature limits,  18.7.
- People may trip over the connecting cable. People may be injured and the charger may be damaged.
 - ▶ Lay the connecting cable flat on the floor.

3.6 Safe Condition

3.6.1 Garden pruner

The garden pruner is in a safe condition if the following points are observed:

- The garden pruner is not damaged.
- The garden pruner is clean.
- The ring and overload ring are not damaged.
- The controls function properly and have not been modified.
- The chain lubrication is operating properly.
- Wear marks on the chain sprocket are not deeper than 0.5 mm.
- A combination of guide bar and saw chain recommended in this User Manual is mounted.

- The guide bar and saw chain are properly mounted.
- The saw chain is properly tensioned.
- Genuine STIHL accessories designed for this garden pruner model are installed.
- The accessories are correctly installed.
- The oil tank cap is closed.

▲ WARNING

- If not in safe condition, components may no longer operate correctly, and safety devices may be rendered ineffective. There is a risk of serious or fatal injury.
 - ▶ Work only with an undamaged garden pruner.
 - ▶ If the garden pruner is dirty: Clean the garden pruner.
 - ▶ Use a garden pruner with an undamaged ring and undamaged overload ring.
 - ▶ Never modify the garden pruner. Exception: Mounting a combination of guide bar and saw chain recommended in this User Manual.
 - ▶ If the controls do not function properly: Do not work with the garden pruner.
 - ▶ Fit genuine STIHL accessories designed for this garden pruner model.
 - ▶ Mount the guide bar and saw chain as described in this User Manual.
 - ▶ Install accessories as described in this User Manual or in the User Manual for the accessories.
 - ▶ Never insert objects into the garden pruner's openings.
 - ▶ Close the oil tank cap.
 - ▶ Replace worn or damaged labels.
 - ▶ If you are unsure: Contact a STIHL authorized dealer.

3.6.2 Guide bar

The guide bar is in a safe condition if the following points are observed:

- Guide bar is not damaged.
- Guide bar is not deformed.
- At least the minimum groove depth is maintained,  18.3.
- Bar groove is not pinched or splayed.

▲ WARNING

- If the guide bar is not in a safe condition, it can no longer support and guide the saw chain properly. The rotating saw chain can jump off the guide bar. This can result in serious or fatal injuries.
 - ▶ Work only with an undamaged guide bar.

- ▶ If the groove depth is less than the minimum depth: Replace the guide bar.
- ▶ If you have any queries: Contact a STIHL servicing dealer for assistance.

3.6.3 Saw Chain

The saw chain is in a safe condition if the following points are observed:

- Chain is not damaged.
- Chain is properly sharpened.
- The service marks on the cutters are still visible.

▲ WARNING

- If components do not comply with safety requirements, they will no longer function properly and safety devices may be rendered inoperative. This can result in serious or fatal injuries.
 - ▶ Work only with an undamaged saw chain.
 - ▶ Sharpen the chain properly.
 - ▶ If you have any queries: Contact your STIHL servicing dealer for assistance.

3.6.4 Battery

The battery is in a safe condition if the following points are observed:

- Battery is undamaged.
- The battery is clean and dry.
- Battery functions properly and has not been modified.

▲ WARNING

- A battery that is not in a safe condition cannot operate safely. Persons may be seriously injured.
 - ▶ Never work with a damaged battery.
 - ▶ Never attempt to charge a damaged or defective battery.
 - ▶ If the battery is dirty: Clean the battery.
 - ▶ If the battery is wet or damp: Allow the battery to dry,  18.8.
 - ▶ Never attempt to modify the battery.
 - ▶ Never insert objects in the battery's openings.
 - ▶ Never bridge the battery's contacts with metallic objects (short circuit).
 - ▶ Do not open the battery.
 - ▶ Replace worn or damaged labels.
- Fluid may leak from a damaged battery. If that liquid comes into contact with the skin or eyes, the skin or eyes may be irritated.
 - ▶ Avoid contact with the liquid.
 - ▶ If skin contact occurs: Wash affected areas of skin with plenty of water and soap.

- ▶ In the event of contact with eyes: Rinse eyes with plenty of water for at least 15 minutes and consult a doctor.
- A damaged or defective battery may smell unusual, emit smoke or burn. Persons may be seriously or fatally injured, and property may be damaged.
 - ▶ If the battery smells unusual or emits smoke: do not use the battery and keep it away from combustible substances.
 - ▶ If the battery catches fire: Attempt to extinguish the battery with a fire extinguisher or water.

3.6.5 Charger

The charger is in a safe condition if the following points are observed:

- Charger is undamaged.
- Charger is clean and dry.

▲ WARNING

- If components do not comply with safety requirements, they will no longer function properly and safety devices may be rendered inoperative. This can result in serious or fatal injuries.
 - ▶ Do not use a damaged charger.
 - ▶ If the charger is dirty or wet: Clean the charger and allow it to dry.
 - ▶ Never attempt to modify the charger.
 - ▶ Never insert objects in the charger's openings.
 - ▶ Never bridge the charger's contacts with metallic objects (short circuit).
 - ▶ Do not open the charger.

3.7 Working

3.7.1 Cutting

▲ WARNING

- Always work within calling distance of others so that you can summon help in an emergency.
 - ▶ Make sure that people are within earshot outside the working area.
- In certain situations, the user may no longer be able to concentrate on their work. The user can lose control of the garden pruner, stumble or fall and be seriously injured.
 - ▶ Work calmly and methodically.
 - ▶ If light and visibility are poor: Do not work with the garden pruner.
 - ▶ Operate the garden pruner alone.
 - ▶ Do not work above shoulder height.
 - ▶ Watch out for obstacles.
- ▶ If you climb in a tree: Use a rope protection.
- ▶ If the user is not trained to climb a tree: Work standing on the ground and keep your balance. If you have to work at a height: Use a mobile elevating work platform or a secure scaffolding.
- ▶ If you start feeling fatigue: Take a break.
- The moving saw chain can cut the user. This may result in serious injury to the user.
 - ▶ Do not touch the rotating saw chain.
 - ▶ Do not hold onto the branches next to the area you intend to cut with the saw chain. The saw chain may slip or jump sideways on the wood and cut your hand. Always guide the garden pruner firmly with both hands.
 - ▶ If the saw chain is blocked by an object: Switch off the garden pruner and remove the batteries. Only then remove the object.
- When you are working in a tree, the garden pruner may fall to the ground. This may result in serious injury to people and damage to property.
 - ▶ Secure garden pruner with a webbing sling via the ring and overload ring. Suitable accessories are available from authorized dealers
- The moving saw chain warms up and expands. If the saw chain is not sufficiently lubricated and retensioned, the saw chain may jump off the guide bar or it may break. This may result in serious injury to people and damage to property.
 - ▶ Use saw chain lubricant.
 - ▶ Regularly check the level in the oil tank during cutting work, no later than after each third charge. Before the oil tank runs empty: Fill up with saw chain oil.
 - ▶ Check the saw chain tension regularly while working. If saw chain tension is insufficient: Tension the saw chain.
- The guide bar, saw chain and chain sprocket can become hot during operation. There is a risk of burn injuries.
 - ▶ Do not touch the hot guide bar, saw chain or chain sprocket.
 - ▶ Wait for the guide bar, saw chain and chain sprocket to cool down.
 - ▶ Wear work gloves made of robust material.
- If the behavior of the garden pruner changes during operation or feels unusual, it may no longer be in a safe condition. This may result in serious injury to people and damage to property.
 - ▶ Stop working, remove the batteries and contact a STIHL authorized dealer.

- Vibrations may occur while using the garden pruner.
 - ▶ Wear gloves.
 - ▶ Take breaks.
 - ▶ If signs of a circulatory disorder occur: Consult a doctor.
- If the moving saw chain hits a hard object, sparks may occur. Sparks can cause fires in a flammable environment. Persons may be seriously or fatally injured, and property may be damaged.
 - ▶ Do not use the chain saw in a flammable environment.
- The saw chain runs on for a short period after you release the trigger. People may be cut by the moving saw chain. People may suffer serious injuries as a result.
 - ▶ Wait for the saw chain to stop moving.

▲ WARNING

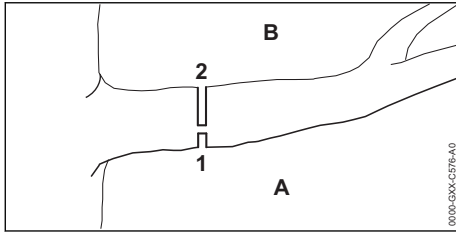

- If you saw wood that is under tension, the guide bar may become jammed. The user can lose control of the garden pruner and be seriously or fatally injured.
 - ▶ Saw a relief cut (1) in the compression side (A) first, then saw a bucking (2) cut in the tension side (B) from above, directly above the first cut.

▲ DANGER

- Working near live electric cables may result in accidental contact with the saw chain and damage the cables. This may result in serious or fatal injury to the user.
 - ▶ Do not work near live wires.

3.8 Reactive Forces

3.8.1 Reactive forces

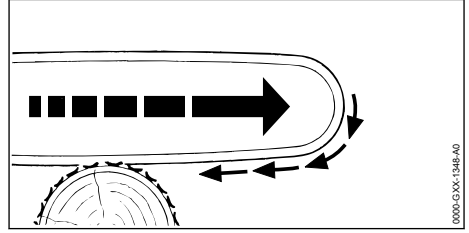

The garden pruner is pulled away from the user if the bottom of the guide bar is used for cutting.

▲ WARNING

- If the rotating saw chain makes contact with a hard object and is suddenly pinched, the garden pruner may be abruptly jerked away from the user. This can result in personal injuries.
 - ▶ Hold the garden pruner firmly with both hands.
 - ▶ Work as described in this User Manual.
 - ▶ Always work with a properly sharpened and tensioned saw chain.
 - ▶ Keep the guide bar straight in the cut.
 - ▶ Apply the limit stop properly.
 - ▶ Work with the engine running at full throttle.

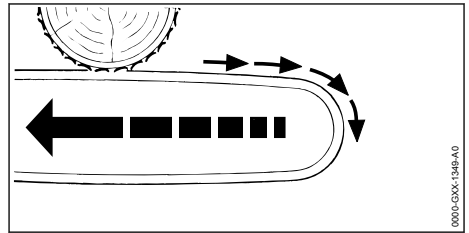

The garden pruner is moved back toward the operator when the top of the guide bar is used for cutting.

▲ WARNING

- If the rotating saw chain makes contact with a hard object and is suddenly pinched, the garden pruner may abruptly jerk toward the user. This can result in personal injuries.
 - ▶ Hold the garden pruner firmly with both hands.
 - ▶ Work as described in this User Manual.
 - ▶ Keep the guide bar straight in the cut.
 - ▶ Work with the engine running at full throttle.

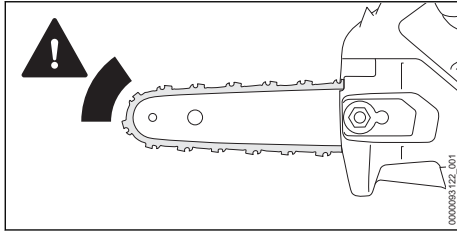

The garden pruner moves back toward the operator when the bar tip is used for cutting.

▲ WARNING

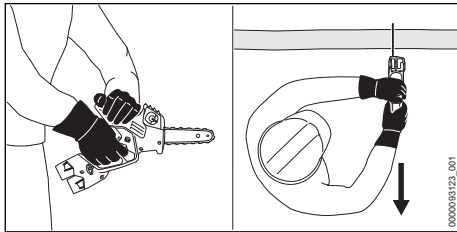

- If the rotating saw chain in the area around the upper quadrant of the guide bar nose makes contact with a hard object and is suddenly pinched or jammed on the guide bar nose, the garden pruner may abruptly jerk toward the user. This can result in personal injuries.
 - ▶ Hold the garden pruner firmly with both hands.
 - ▶ Always keep your body out of the swivel range of the garden pruner.
 - ▶ Work as described in this User Manual.
 - ▶ Do not cut with the upper quadrant of the bar nose.
 - ▶ Always work with a properly sharpened and tensioned saw chain.
 - ▶ Work with the engine running at full throttle.

3.9 Charging

▲ WARNING

- During charging, a damaged or defective charger may give off an unusual smell or smoke. Persons may be injured or property may be damaged.
 - ▶ Disconnect the mains plug from the power outlet.
 - ▶ Remove the batteries.
- Insufficient heat dissipation may cause the charger to overheat and a fire to break out. Persons may be seriously or fatally injured, and property may be damaged.
 - ▶ Do not cover the charger.

3.10 Connecting to the power supply

Contact with live components may occur for the following reasons:

- The connecting cable or the extension cord is damaged.
- The mains plug of the connecting cable or extension cord is damaged.
- The socket is not properly installed.

▲ DANGER

- Contact with live parts may result in electric shock. This may result in serious or fatal injury to the user.
 - ▶ Make sure that the connecting cable, extension cord and their mains plugs are undamaged.



If the connecting cable or the extension cord is damaged:

- ▶ Do not touch the damaged area.
- ▶ Disconnect the mains plug from the power supply.
- ▶ Make sure your hands are dry before touching the connecting cable, extension cord or mains plugs.
- ▶ Plug the mains plug of the connecting cable or extension cord into a properly installed, shockproof socket with the correct fuse rating.
- ▶ Install the charger with a ground fault circuit interrupter (30 mA, 30 ms).
- A damaged or unsuitable extension cable can result in electric shock. There is a risk of serious or fatal injury.
 - ▶ Use an extension cable with the correct cable cross-section,  18.6.

▲ WARNING

- Overvoltage can occur in the charger if the line voltage or frequency are incorrect during charging. The charger may be damaged.
 - ▶ Make sure that the mains voltage and the mains frequency of the power supply match the data on the rating plate of the charger.
- If the charger is connected to a power strip, electrical components may be overloaded during the charging process. The components may overheat and cause a fire. Persons may be seriously or fatally injured, and property may be damaged.
 - ▶ Ensure that the technical specifications for the power strip are not exceeded by the information on the rating plate of the charger and of all electrical devices connected to the power strip.
- An incorrectly routed connecting cable or extension cord may be damaged, and people

may trip over it. People may be injured, and the connecting cable or extension cord may be damaged.

- ▶ Route and mark the connecting cable and extension cord so that people will not trip over them.
- ▶ Route the connecting cable and extension cord so that they are not under tension or tangled.
- ▶ Route the connecting cable and extension cord so that they will not be damaged, kinked or crushed and will not be chafed.
- ▶ Protect the connecting cable and extension cord from heat, oil and chemicals.
- ▶ Lay the connecting cable and extension cord on a dry surface.
- The extension cable warms up in operation. If that heat cannot escape, it may cause a fire.
 - ▶ If using a cable reel: completely unroll the cable reel.
- If wiring and pipes are laid in the wall, they may be damaged if the charger is mounted on the wall. Contact with wiring can result in electric shock. This may result in serious injury to people and damage to property.
 - ▶ Make sure there is no wiring or pipes in the wall at the proposed mounting site.
- If the charger is not mounted on the wall as described in this User Manual, the charger or the battery may fall or the charger may over-heat. This may result in injury to people and damage to property.
 - ▶ Mount the charger on a wall as described in this User Manual.
- If the charger is mounted on a wall with the battery inserted, the battery may fall out of the charger. This may result in injury to people and damage to property.
 - ▶ Mount the charger on the wall first before inserting the battery.

3.11 Transporting

3.11.1 Garden pruner

⚠ WARNING

- The garden pruner may tip over or shift during transport. People may be injured or property may be damaged.



- ▶ Remove the batteries.

- ▶ Push the chain scabbard over the guide bar so that it completely covers the guide bar.

- ▶ Transport the garden pruner in the supplied case.
- ▶ If no case is supplied with the garden pruner: Secure the garden pruner with lashing straps or a net to prevent it tipping over or moving.

3.11.2 Battery

⚠ WARNING

- The battery is not protected against all ambient conditions. The battery may be damaged if it is exposed to certain ambient conditions, and damage to property may occur.
 - ▶ Never transport a damaged battery.
 - ▶ If a case is supplied: Transport the battery in the supplied case.
- The battery may tip over or shift during transport. People may be injured or property may be damaged.
 - ▶ Pack the battery in packaging in such a way that it cannot move.
 - ▶ Secure the packaging so that it cannot move.

3.11.3 Charger

⚠ WARNING

- The charger can tip over or shift while being transported. Persons may be injured or property may be damaged.
 - ▶ Disconnect the mains plug from the socket.
 - ▶ Remove the batteries.
 - ▶ Transport the charger in the case supplied.
 - ▶ If no case is supplied with the charger: Secure the charger with lashing straps, belts or a net to prevent it tipping over and moving.
- The connecting cable should not be used for carrying the charger. The connecting cable and the charger may be damaged.
 - ▶ Wind up the connecting cable and attach it to the charger.

3.12 Storing

3.12.1 Garden pruner

⚠ WARNING

- Children are not aware of and cannot assess the dangers of the garden pruner Children may be seriously injured.



- ▶ Remove the batteries.

- ▶ Push the chain scabbard over the guide bar so that it completely covers the guide bar.
- ▶ Store the garden pruner out of the reach of children.
- Dampness can corrode the electrical contacts on the garden pruner and other metal components. The garden pruner may be damaged.
 - ▶ Remove the batteries.



- ▶ Store the garden pruner in a clean and dry condition.

3.12.2 Battery

⚠ WARNING

- Children are not aware of and cannot assess the dangers of the battery. Children may be seriously injured.
 - ▶ Store the battery out of the reach of children.
- The battery is not protected against all ambient conditions. If the battery is exposed to certain ambient conditions, the battery may be irreparably damaged.
 - ▶ Store the battery in a clean and dry condition.
 - ▶ Store the battery in an enclosed space.
 - ▶ Store the battery separately from the garden pruner.
 - ▶ If the battery is stored in the charger, disconnect the mains plug and store the rechargeable battery at a battery charge status between 40 % and 60 % (2 lit green LEDs).
 - ▶ Do not store the battery outside of the specified temperature limits, 18.7.

3.12.3 Charger

⚠ WARNING

- Children are not aware of and cannot assess the dangers of a charger. Children can be seriously injured or killed.
 - ▶ Disconnect the plug from the wall outlet.
 - ▶ Store the charger out of reach of children.
- The charger is not protected against all ambient conditions. If the charger is exposed to certain ambient conditions, the charger may be damaged.
 - ▶ Disconnect the plug from the wall outlet.
 - ▶ If the charger is hot: Allow the charger to cool down.
 - ▶ Store the charger in a clean, dry place.
 - ▶ Store the charger in an enclosed room.

- ▶ Do not store the charger outside of the specified temperature limits, 18.7.
- The connecting cable should not be used for carrying the charger or hanging up the charger. The connecting cable and the charger may be damaged.
 - ▶ Hold the charger by the housing in a secure grip.
 - ▶ Hang the charger on the wall mounting.

3.13 Cleaning, maintenance and repair

⚠ WARNING

- The garden pruner may start unintentionally if the batteries are left in place during cleaning, maintenance or repair operations. This may result in serious injury to people and damage to property.



- ▶ Remove the batteries.
- Cleaning with harsh cleaning agents, a water jet, or pointed objects can damage the garden pruner, guide bar, saw chain, the battery and charger. If the garden pruner, guide bar, saw chain, battery or charger are not cleaned correctly, components may no longer function properly or safety devices may be rendered inoperative. People may suffer serious injuries as a result.
 - ▶ Clean the garden pruner, guide bar, saw chain, battery and charger as described in this user manual.
- If the garden pruner, guide bar, saw chain, battery or charger are not properly serviced, components may no longer function properly or safety devices may be rendered inoperative. There is a risk of serious or fatal injury.
 - ▶ Do not attempt to service or repair the garden pruner, battery or charger yourself.
 - ▶ If the garden pruner, battery or the charger require servicing or repairs: Contact a STIHL servicing dealer for assistance.
 - ▶ Service or repair the guide bar and saw chain as described in this User Manual.
- The user may be cut by the sharp cutters while cleaning or servicing the saw chain. This may result in injury to the user.
 - ▶ Wear work gloves made of robust material.

4 Preparing Garden Pruner for Operation

4.1 Preparing the garden pruner for operation

The following steps must be performed before commencing work:

- ▶ Ensure that the following components are in a safe condition:
 - Garden pruner, [13](#) 3.6.1.
 - Guide bar, [13](#) 3.6.2.
 - Saw chain, [13](#) 3.6.3.
 - Battery, [13](#) 3.6.4.
 - Charger, [13](#) 3.6.5.
- ▶ Check the battery, [13](#) 9.6.
- ▶ Fully charge the battery, [13](#) 5.2.
- ▶ Clean the garden pruner, [13](#) 14.1.
- ▶ Mount the guide bar and saw chain, [13](#) 6.1.2.
- ▶ Tension the saw chain, [13](#) 6.2.
- ▶ Fill up with saw chain oil, [13](#) 6.3.
- ▶ Check the controls, [13](#) 9.4.
- ▶ Check the chain lubrication, [13](#) 9.5.
- ▶ If you cannot carry out these steps: Do not use the garden pruner and contact a STIHL dealer instead.

5 Charging the Battery, LEDs

5.1 Mounting the charger on a wall

The charger can be mounted on a wall.

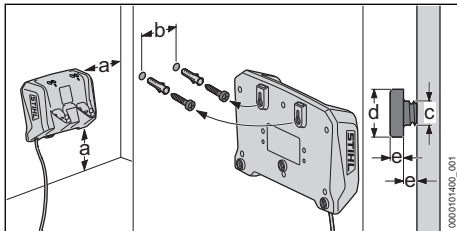

- ▶ Check the following points when mounting the charger on a wall:
 - Use suitable mounting materials.
 - The charger is level.
 The following dimensions are observed:
 - a = at least 100 mm
 - b (for AL 1 and AL 5) = 54 mm
 - b (for AL 5-2) = 100 mm
 - c = 4.5 mm
 - d = 9 mm
 - e = 2.5 mm

5.2 Charging the battery

The charging time depends on various factors, e.g. the battery temperature or the ambient temperature. For optimum performance, note the recommended temperature ranges, [13](#) 18.8. The actual charging time may vary from the charging time indicated. The charging time is indicated at www.stihl.com/charging-times.

The charging process starts automatically when the mains plug is plugged into a socket and the battery is inserted into the charger. The charger switches off automatically when the battery is fully charged.

The battery and the charger warm up during charging.

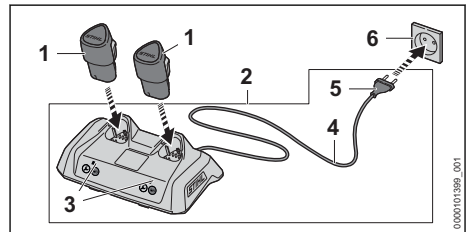

- ▶ Insert the mains plug (5) in a convenient wall outlet (6).
The charger (2) runs a self test. The LED (3) glows green for about 1 second and then red for about 1 second.
- ▶ Fit the connecting cable (4).
- ▶ Insert the battery (1) in the guides in the charger (2) and press it home as far as stop. The LED (3) glows or flashes green. The battery (1) is being charged.
- ▶ When the LED (3) stops glowing: The battery (1) is fully charged and can be taken out of the charger (2).
- ▶ If the charger (2) is no longer being used: Disconnect the mains plug (5) from the socket (6).

5.3 Displaying the state of charge

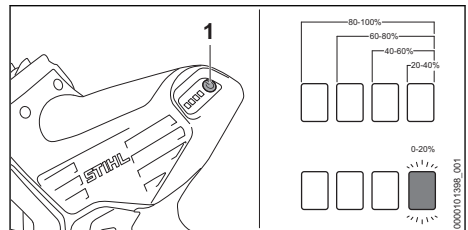

- ▶ Insert the batteries.

- ▶ Depress the pushbutton (1).
The LEDs light up green for about 5 seconds and indicate the state of charge.
- ▶ If the LED on the right flashes green: Charge the battery.

NOTICE

- The LEDs always indicate the battery with the lowest state of charge. To display the state of charge of an individual battery:
 - ▶ Insert the battery only in the upper battery compartment.
 - ▶ Depress the pushbutton (1).

NOTICE

- If the battery is inserted only in the bottom battery compartment, the LEDs on the garden pruner will not function.
 - ▶ Insert both batteries or at least one battery in the upper battery compartment.
 - ▶ Depress the pushbutton (1).

5.4 LEDs on Garden Pruner

The LEDs can show the state of charge or malfunctions. The LEDs can glow or flash green or red.

The state of charge is indicated when the LEDs glow or flash green.

- ▶ If the LEDs glow or flash red: Troubleshooting, [17](#).

There is a malfunction in the garden pruner or battery.

5.5 LED on Charger

The LED indicates the operating status of the charger or faults. The LED can glow or flash green or red.

If the LED glows or flashes green, the battery is being charged.

- ▶ If the LED glows or flashes red: Troubleshooting, [17](#).

There is a malfunction in charger or battery.

6 Assembling the Garden Pruner

6.1 Removing and Fitting the Bar and Chain

6.1.1 Removing the guide bar and saw chain

- ▶ Switch off the garden pruner and remove the batteries.

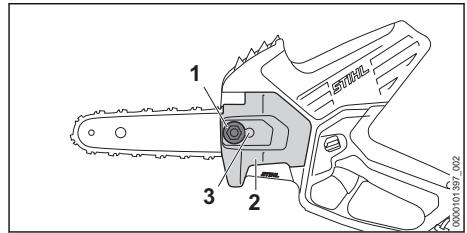

- ▶ Turn the nut (1) counterclockwise until the chain sprocket cover (2) can be removed.
- ▶ Remove the chain sprocket cover (2).
- ▶ Turn the tensioning screw (3) counterclockwise as far as it will go.
The saw chain is now slack.
- ▶ Remove the guide bar and saw chain.

6.1.2 Mounting the guide bar and saw chain

The guide bar and saw chain combinations that can be used with the chain sprocket are listed in the specifications, [19](#).

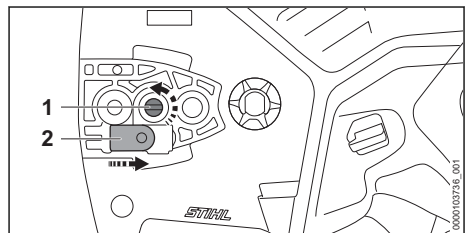

- ▶ Turn the tensioning screw (1) counterclockwise until the tensioner slide (2) rests against the right end of the housing.

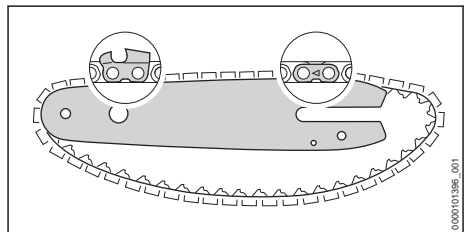

- ▶ Place the saw chain in the guide bar groove so that the arrows on the links on the top of the bar point in the direction of rotation.

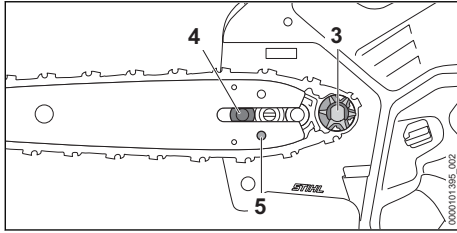

- ▶ Fit the guide bar and saw chain on the garden pruner and check the following points:
 - The drive links of the saw chain are seated in the teeth of the chain sprocket (3).
 - The head of the collar stud (4) is in the guide bar's slot.
 - The peg of tensioner slide (2) engages the hole (5) in guide bar.

The guide bar may be fitted in either direction. The logo on the guide bar may also be upside down.

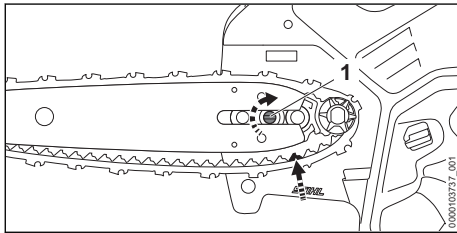

- ▶ Turn the tensioning screw (1) clockwise until the saw chain fits snugly against the guide bar. Make sure the drive links of the saw chain run in the guide bar groove. The guide bar and saw chain fit snugly against the garden pruner.
- ▶ Fit the chain sprocket cover on the garden pruner so that it is flush with the garden pruner.
- ▶ Rotate the nut clockwise until the chain sprocket cover is firmly seated on the garden pruner.

6.2 Tensioning the Saw Chain

The saw chain expands or contracts during cutting work. The saw chain tension changes as a result. Check the saw chain tension regularly during operation and readjust if necessary.

- ▶ Switch off the garden pruner and remove the batteries.

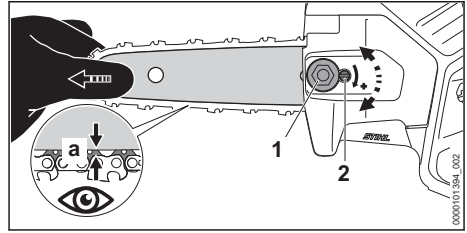

- ▶ Loosen the nut (1).
- ▶ Lift the guide bar nose and turn the tensioning screw (2) clockwise or counterclockwise until the following conditions are met:
 - The chain sag in the center of the guide bar is 1 - 2 mm.
 - The saw chain can still be pulled easily along the guide bar with two fingers.
- ▶ Continue lifting the bar nose and tighten the nut (1) firmly.
- ▶ If the distance 'a' in the center of the guide bar is not 1-2 mm: Readjust the saw chain tension.

6.3 Filling up with saw chain oil

The saw chain oil lubricates and cools the rotating chain.

STIHL recommends you use a STIHL saw chain oil or an equivalent chain oil approved for chainsaws.

- ▶ Switch off the garden pruner and remove the batteries.
- ▶ Place your garden pruner on a level surface so that the oil tank cap faces up.
- ▶ Use a damp cloth to clean the oil tank cap and the area around it.

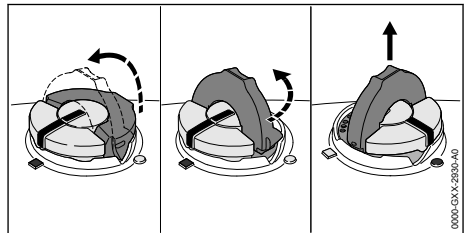

- ▶ Swing the grip on the oil tank cap to the vertical position.
- ▶ Turn the oil tank cap counterclockwise as far as it will go.
- ▶ Remove the oil tank cap.
- ▶ Fill up with saw chain oil, taking care not to spill any oil and not to overfill the tank.

- ▶ If the grip on the oil tank cap has dropped into the closed position: Raise the grip until it is vertical.

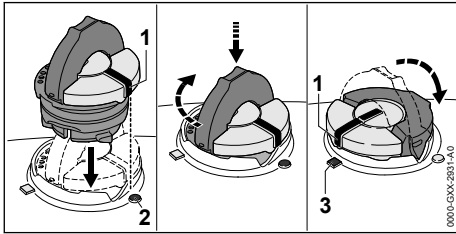

- ▶ Place the oil tank cap in the filler opening so that mark (1) lines up with mark (2).
- ▶ Press the oil tank cap down and rotate it clockwise as far as it will go. The oil tank cap snaps into place. The mark (1) points to mark (3).
- ▶ Check to see if the oil tank cap can be pulled upwards and off.
- ▶ If the oil tank cap cannot be pulled upwards and off: Fold down the grip on the oil tank cap. The oil tank is closed.

If the oil tank cap can be pulled upwards and off, perform the following steps:

- ▶ Place the oil tank cap in the filler opening – in any position.

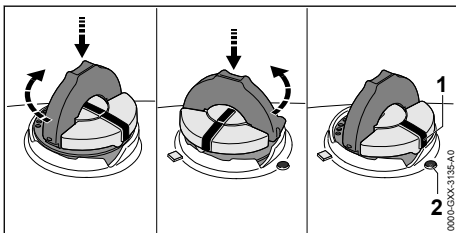

- ▶ Press the oil tank cap down and rotate it clockwise as far as it will go.
- ▶ Press the oil tank cap down and rotate it counter-clockwise until mark (1) points to mark (2).
- ▶ Now try again to close the oil tank.
- ▶ If the oil tank still cannot be closed properly: Do not use the garden pruner and contact a STIHL authorized dealer instead. The garden pruner is not in a safe condition.

7 Removing and Fitting the Battery

7.1 Inserting the battery

Stihl recommends using and marking the batteries in pairs.

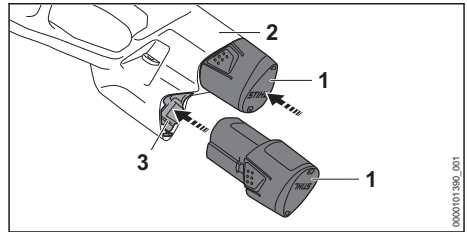

- ▶ Insert the battery (1) into the battery compartment (2, 3) as far as it will go. The battery (1) engages in position with a click.

7.2 Removing the battery

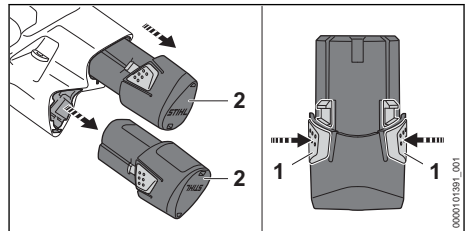

- ▶ Depress both locking hooks (1). The battery (2) is now unlocked and can be removed.

8 Switching On and Off

8.1 Switching on the garden pruner

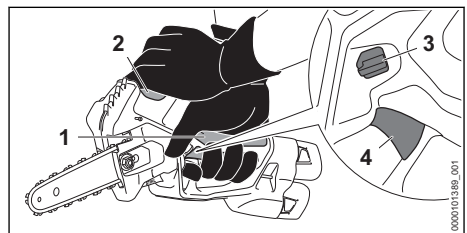

- ▶ Hold the garden pruner firmly with one hand on the grip area (1) of the control handle so that your thumb wraps around the control handle.
- ▶ Hold and control the garden pruner with your other hand on the grip (2).
- ▶ Press and hold the locking lever (3) with your thumb.
- ▶ Press and hold the trigger (4) with your index finger. The garden pruner accelerates and the saw chain rotates. The locking lever (3) can be released.

8.2 Switching off the garden pruner

- ▶ Release the trigger.
 - The saw chain stops running.
- ▶ If the saw chain continues to run: Remove the batteries and contact a STIHL authorized dealer for assistance.
 - The garden pruner is defective.

9 Checking the Garden Pruner and Battery

9.1 Checking the chain sprocket

- ▶ Switch off the garden pruner and remove the batteries.
- ▶ Remove the chain sprocket cover.
- ▶ Remove the guide bar and saw chain.

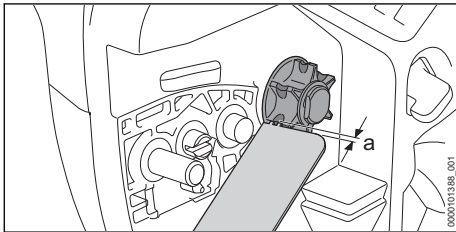

- ▶ Use a STIHL gauge to check the wear marks on the chain sprocket.
- ▶ If wear marks are deeper than $a = 0.5 \text{ mm}$: Do not use the garden pruner and contact a STIHL authorized dealer instead.
 - The chain sprocket must be replaced.

9.2 Checking the guide bar

- ▶ Switch off the garden pruner and remove the batteries.
- ▶ Remove the saw chain and guide bar.

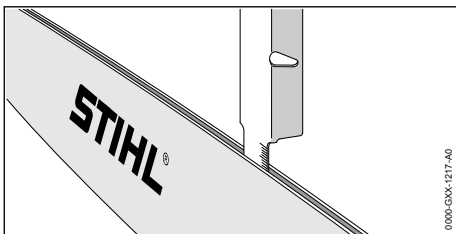



- ▶ Measure the depth of the guide bar with the scale on a STIHL filing gauge.
- ▶ Install a new guide bar if one of the following points applies:
 - The guide bar is damaged.
 - The measured guide bar groove depth is less than specified minimum depth,  18.3.
 - The guide bar groove is pinched or splayed.

- ▶ If you are unsure: Contact a STIHL authorized dealer.

9.3 Checking the saw chain

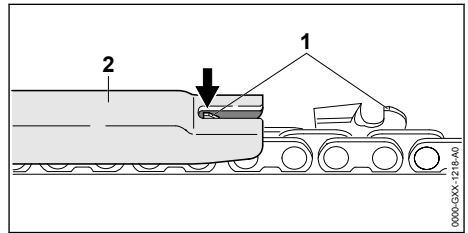
- ▶ Switch off the garden pruner and remove the batteries.



- ▶ Measure the height of the depth limiters (1) with a STIHL filing gauge (2). The STIHL filing gauge must match the pitch of the saw chain.
- ▶ If a depth gauge (1) projects from the filing gauge (2): Lower the depth gauge (1) with a file,  15.3.

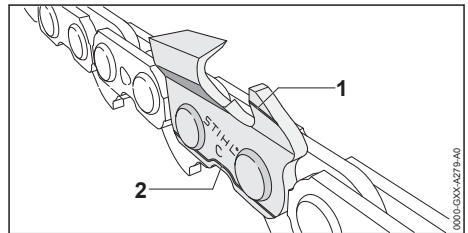

- ▶ Make sure the wear marks (1 and 2) on the cutters are visible.
- ▶ If one of the wear marks is not visible on a cutter: Do not use your saw chain and contact a STIHL authorized dealer instead.
- ▶ Use a STIHL filing gauge to check that the filing angle is 30° on all cutters. The STIHL filing gauge must match the pitch of the saw chain.
- ▶ If the filing angle of 30° has not been maintained: Resharpener the saw chain.
- ▶ If you are unsure: Contact a STIHL authorized dealer.

9.4 Checking the controls

Lockout lever and trigger

- ▶ Remove the batteries.
- ▶ Try pressing the trigger without pressing the locking lever.
- ▶ If the trigger can be pulled: Do not use your garden pruner and contact a STIHL servicing dealer.
 - The locking lever is defective.
- ▶ Press and hold the locking lever.
- ▶ Press and release the trigger.

- ▶ If the trigger is stiff or does not spring back to its idle position: Do not use the garden pruner and contact your STIHL dealer for assistance. The trigger has a malfunction.

Switching on the garden pruner

- ▶ Insert batteries.
- ▶ Press and hold the locking lever.
- ▶ Press and hold the trigger.
 - The saw chain starts running.
- ▶ If 3 LEDs are flashing red: Remove the batteries and consult a STIHL authorized dealer. There is an error in the garden pruner.
- ▶ Release the trigger.
 - The saw chain stops running.
- ▶ If the saw chain continues to run: Remove the batteries and contact a STIHL authorized dealer for assistance. The garden pruner is defective.

9.5 Checking chain lubrication

- ▶ Insert batteries.
- ▶ Point the guide bar at a light surface.
- ▶ Switch on the garden pruner.
 - Saw chain oil is spun off the chain and is visible on the light surface. The chain lubrication is operating properly.
- ▶ If no excess saw chain oil is visible:
 - ▶ Fill up with saw chain oil.
 - ▶ Check chain lubrication again.
 - ▶ If saw chain oil is still not visible on the light surface: Do not use your garden pruner and contact a STIHL authorized dealer instead. Chain lubrication is defective.

9.6 Checking the battery

- ▶ Insert the battery in the upper battery compartment.
- ▶ Press the pushbutton on the garden pruner.
 - The LEDs light up or flash.
- ▶ Remove the battery and insert the other battery in the upper battery compartment.
- ▶ Press the pushbutton on the garden pruner.
 - The LEDs light up or flash.
- ▶ Insert both batteries.
- ▶ Press the pushbutton on the garden pruner.
 - The LEDs light up or flash.
- ▶ If the LEDs do not light up or flash: Do not use the garden pruner or battery and contact a STIHL authorized dealer instead. There is an error in the garden pruner or battery.

10 Using the Garden Pruner

10.1 Holding and controlling the garden pruner

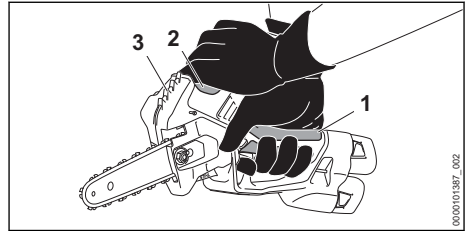

- ▶ Hold and control the garden pruner with one hand on the grip area (1) of the control handle so that your thumb wraps around the control handle.
- ▶ Hold and control the garden pruner with your other hand on the grip (2). Do not reach into the area of the teeth (3).

10.2 Cutting

- ▶ Start cutting with the chain running at full speed.

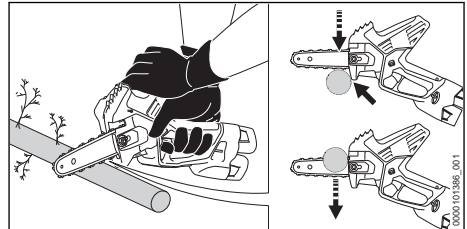

- ▶ Engage the stop and use it as a fulcrum.
- ▶ Continue cutting until guide bar is completely through the branch.
- ▶ Take the weight of the garden pruner at the end of the cut.
- ▶ Cut one branch at a time.

For optimum performance, note the recommended temperature ranges, 18.8.

10.3 Limbing

- ▶ With the chain running at full speed, pivot the guide bar downward against the limb.

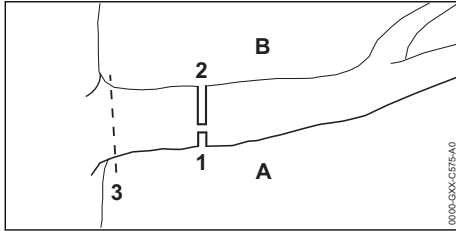

- ▶ Make a relieving cut (1) in the compression side (A) first, then perform a bucking (2) cut at the tension side (B) from above, directly above the first cut.
- ▶ Make the last cut (3) close to the trunk without damaging the bark.

11 After Finishing Work

11.1 After finishing your work

- ▶ Switch off the garden pruner and remove the batteries.
- ▶ If the garden pruner is wet: Allow the garden pruner to dry.
- ▶ If the battery is moist or wet: Allow the battery to dry,  18.8.
- ▶ Clean the garden pruner.
- ▶ Clean the guide bar and saw chain.
- ▶ Push the chain scabbard over the guide bar so that it completely covers the guide bar.
- ▶ Clean the battery.

12 Transporting

12.1 Transporting the garden pruner

- ▶ Switch off the garden pruner and remove the batteries.
- ▶ Push the chain scabbard over the guide bar so that it completely covers the guide bar.

Carrying the Garden Pruner

- ▶ Carry the garden pruner with one hand on the control handle with the guide bar pointing down.

Transporting the garden pruner in a vehicle

- ▶ Transport the garden pruner in the supplied case.
- ▶ Secure the case so that it cannot tip over or move.
- ▶ If no case is supplied with the garden pruner: Secure the garden pruner so that it cannot tip over or move.

Transporting the garden pruner by carrying it on the ring with the overload ring or by the carabiner

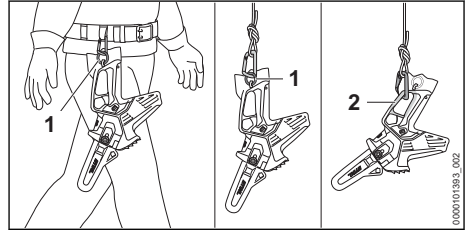

- ▶ Transport the garden pruner by means of the ring with the overload ring (1) on the belt or on a rope or attach the carabiner in the rear grip area (2).

Transporting the chain scabbard via the ring

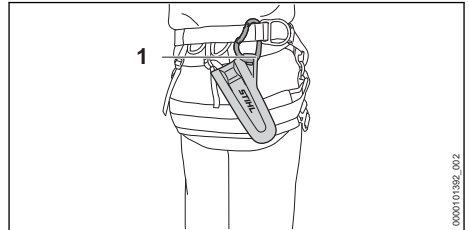

- ▶ Transport the chain scabbard by the ring (1) on the belt.

12.2 Transporting the battery

- ▶ Switch off the garden pruner and remove the batteries.
- ▶ Check that the battery is in a safe condition.
- ▶ Transport the battery in the case supplied.
- ▶ If no case is supplied with the battery: Pack the battery in packaging so that it cannot move.
- ▶ Secure the packaging so that it cannot move.

The battery is subject to the Carriage of Dangerous Goods regulations. The battery is classified as UN 3480 (lithium ion batteries) and has been tested pursuant to UN Manual Tests and Criteria Part III, Subsection 38.3.

The transport regulations can be found at www.stihl.com/safety-data-sheets.

12.3 Transporting the charger

- ▶ Disconnect the mains plug from the socket.
- ▶ Remove the batteries.
- ▶ Wind up the connecting cable and attach it to the charger.

- ▶ When transporting the charger in a vehicle:
 - ▶ Transport the charger in the supplied case.
 - ▶ Secure the case so that the case cannot tip over or move.
- ▶ If no case is supplied with the charger:
 - ▶ Secure the charger so it cannot tip over or move.

13 Storing

13.1 Storing the garden pruner

- ▶ Switch off the garden pruner and remove the batteries.
- ▶ Push the chain scabbard over the guide bar so that it completely covers the guide bar.
- ▶ Check the following points when storing the garden pruner:
 - The garden pruner cannot turn over or move.
 - The garden pruner is out of the reach of children.
 - The garden pruner is clean and dry.
- ▶ If the garden pruner is stored for longer than 30 days: Remove the guide bar and saw chain.

13.2 Storing the Battery

STIHL recommends keeping the battery in a charging state between 40% and 60 % (2 green LEDs lit).

- ▶ The battery should be stored in such a way that the following conditions are fulfilled:
 - The battery is out of the reach of children.
 - The battery is clean and dry.
 - The battery is in an enclosed space.
 - Battery is stored separately from the garden pruner.
 - If the battery is stored in the charger, disconnect the mains plug and store the rechargeable battery at a battery charge status between 40 % and 60 % (2 lit green LEDs).
 - Do not store the battery outside of the specified temperature limits,  18.7.

NOTICE

- If the battery is not stored as described in this user manual, the battery may become deeply discharged and irreparably damaged.
 - ▶ Charge a discharged battery before storing it. STIHL recommends keeping the battery in a charging state between 40% and 60% (2 lit green LEDs).
 - ▶ Store the battery separately from the garden pruner.

13.3 Storing the charger

- ▶ Disconnect the mains plug from the socket.

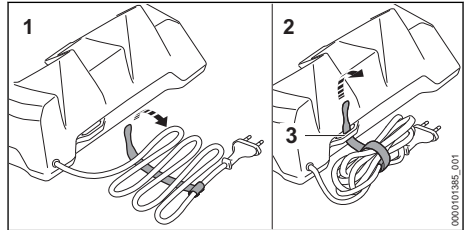

- ▶ Wind up the connecting cable and attach it to the charger.
- ▶ Observe the following points when storing the charger:
 - Charger is out of the reach of children.
 - The charger is clean and dry.
 - Charger is in an enclosed space.
 - The charger is not suspended from the connecting cable or the holder (3) for the connecting cable.
 - The charger is not stored outside of the specified temperature limits,  18.7.

14 Cleaning

14.1 Cleaning the garden pruner

- ▶ Switch off the garden pruner and remove the batteries.
- ▶ Clean the garden pruner with a damp cloth or STIHL resin solvent.
- ▶ Clean vents with a paintbrush.
- ▶ Remove the chain sprocket cover.
- ▶ Clean the area around the chain sprocket with a damp cloth or STIHL resin solvent.
- ▶ Remove foreign objects from the battery compartment and clean the battery compartment with a damp cloth.
- ▶ Use a paintbrush or soft brush to clean the electrical contacts in the battery compartment.
- ▶ Attach the chain sprocket cover.

14.2 Cleaning the guide bar and saw chain

- ▶ Switch off the garden pruner and remove the batteries.
- ▶ Remove the guide bar and saw chain.

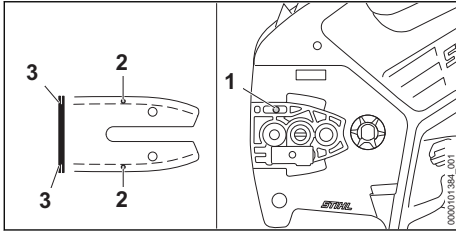

- ▶ Clean the oil port (1), oil inlet hole (2) and bar groove (3) with a soft brush or STIHL resin solvent.
- ▶ Clean the saw chain with a soft brush or STIHL resin solvent.
- ▶ Install the guide bar and saw chain.

14.3 Cleaning the Battery

- ▶ Clean the battery with a damp cloth.

14.4 Cleaning the Charger

- ▶ Disconnect the mains plug from the power supply.
- ▶ Clean the charger with a damp cloth.
- ▶ Clean the charger's electrical contacts with a paintbrush or a soft brush.

15 Maintenance

15.1 Maintenance intervals

Maintenance intervals depend on the ambient conditions and the operating conditions. STIHL recommends the following maintenance intervals:

Weekly

- ▶ Check the chain sprocket.
- ▶ Check and deburr the guide bar.
- ▶ Check and sharpen the saw chain.

Annually

- ▶ Have the oil tank cleaned by a STIHL dealer.

15.2 Deburring the Guide Bar

A burr can build up on the outer edge of the guide bar.

- ▶ Remove burr with a flat file or a STIHL guide bar dressing tool.
- ▶ If you have any queries: Contact your STIHL servicing dealer.

15.3 Sharpening the saw chain

Sharpening saw chains correctly takes a lot of practice.

STIHL files, STIHL filing aids, STIHL sharpeners and STIHL 2-in-1 file holders and the brochure

“Sharpening STIHL Saw Chains” will help you sharpen the blade correctly. To obtain the brochure visit <http://www.stihl.com/sharpening-brochure>.

STIHL recommends having saw chains sharpened by a STIHL authorized dealer.

! WARNING

- The saw chain's cutters are sharp. There is a risk of cutting oneself.
 - ▶ Wear work gloves made of robust material.

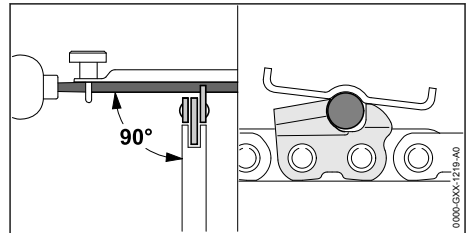

- ▶ File each cutter with a round file so that the following conditions are met:
 - The round file matches the pitch of the saw chain.
 - The round file is pushed from the inside to the outside.
 - The round file is pushed at a right angle to the guide bar.
 - Maintain a filing angle of 30°.

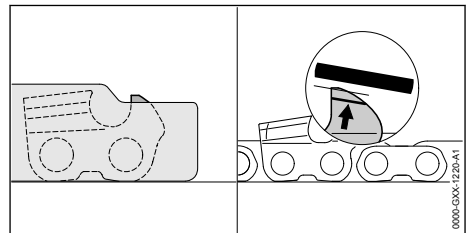

- ▶ File the depth gauges with a flat file so that they are flush with the STIHL filing gauge and parallel to the wear mark. The STIHL filing gauge must match the saw chain pitch.
- ▶ If you are unsure: Contact a STIHL authorized dealer.

16 Repairing

16.1 Repairing the Garden Pruner, Battery and Charger

The garden pruner, guide bar, saw chain, battery and charger are not user serviceable.

- ▶ If the garden pruner, guide bar or saw chain are damaged: Do not use your garden pruner, guide bar or saw chain, and contact your STIHL servicing dealer for assistance.
- ▶ If the battery has a malfunction or is damaged: Replace the battery.
- ▶ If the charger has a malfunction or is damaged: Replace the charger.
- ▶ If the connecting cable has a malfunction or is damaged: Do not use the charger and have connecting cable replaced by a STIHL servicing dealer.

17 Troubleshooting

17.1 Troubleshooting the garden pruner or battery

Error	LEDs on garden pruner	Cause	Remedy
Garden pruner does not run when switched on.	1 LED flashes green.	The state of charge of at least one battery is too low.	<ul style="list-style-type: none"> ▶ Insert the batteries one after the other in the upper battery compartment and display the state of charge. ▶ Charge the battery.
	1 LED lights up steady red.	At least one battery is too hot or too cold.	<ul style="list-style-type: none"> ▶ Remove the batteries. ▶ Insert the batteries into the charger. If the LED on the battery compartment of the charger lights up red, the battery is too hot or too cold. ▶ Allow the battery to cool down or warm up.
	3 LEDs flash red.	There is an error in the garden pruner.	<ul style="list-style-type: none"> ▶ Remove the batteries and insert them again. ▶ Switch on the garden pruner. ▶ If 3 LEDs continue to flash red: Do not use the garden pruner and contact your STIHL dealer for assistance.
	3 LEDs light up red.	The garden pruner is too hot.	<ul style="list-style-type: none"> ▶ Remove the batteries. ▶ Allow the garden pruner to cool down.
	4 LEDs flash red.	There is an error in at least one battery.	<ul style="list-style-type: none"> ▶ Remove the batteries. ▶ Clean the electrical contacts in the battery compartment. ▶ Insert batteries. ▶ Switch on the garden pruner. ▶ If 4 LEDs continue to flash red: Remove batteries. ▶ Insert the batteries into the charger. If the LED on the battery compartment of the charger flashes red, there is a battery error. Do not use the battery. Consult a STIHL authorized dealer.
		No electrical contact between garden pruner and batteries.	<ul style="list-style-type: none"> ▶ Remove the batteries. ▶ Clean the electrical contacts in the battery compartment. ▶ Insert batteries.
		Garden pruner or batteries damp.	<ul style="list-style-type: none"> ▶ Allow the garden pruner or batteries to dry,  18.8.
Garden pruner cuts out during operation.	3 LEDs light up red.	The garden pruner is too hot.	<ul style="list-style-type: none"> ▶ Remove the batteries. ▶ Allow the garden pruner to cool down.
		There is an electrical error.	<ul style="list-style-type: none"> ▶ Remove the batteries and insert them again. ▶ Switch on the garden pruner.

Error	LEDs on garden pruner	Cause	Remedy
Cutting performance of garden pruner deteriorates. The garden pruner runtime is too short.	1 LED flashes green.	The state of charge of at least one battery is too low.	<ul style="list-style-type: none"> ▶ Insert the batteries one after the other in the upper battery compartment and display the state of charge. ▶ Charge the battery.
		The saw chain has not been correctly sharpened.	▶ Sharpen chain as specified.
		The saw chain is over-tensioned.	▶ Tension the saw chain as specified.
		At least one battery is not fully charged.	<ul style="list-style-type: none"> ▶ Insert the batteries one after the other in the upper battery compartment and display the state of charge. ▶ Fully charge the battery.
		The service life of at least one battery has expired.	▶ Replace the battery.
Smell of smoke or burning in the cutting area.		The saw chain has not been correctly sharpened.	▶ Sharpen chain as specified.
		Insufficient saw chain oil in the oil tank.	▶ Fill up with saw chain oil.
		The chain lubrication system is supplying insufficient saw chain oil.	▶ Clean the guide bar and saw chain.
		The saw chain is over-tensioned.	▶ Tension the saw chain as specified.
		The garden pruner is not being used correctly.	▶ Have correct use explained and then practice correct use.

17.2 Troubleshooting the Charger

Fault	LED on Charger	Cause	Remedy
Battery not being charged.	One LED glows red.	The battery is too warm or too cold.	▶ Leave battery inserted in charger. Charging starts automatically as soon as the permitted temperature range is reached.
	The LED flashes red.	No electrical contact between charger and battery.	<ul style="list-style-type: none"> ▶ Remove the battery. ▶ Clean contacts on charger. ▶ Insert battery.
		There is a malfunction in the charger.	▶ Do not use the charger and contact your STIHL dealer for assistance.
	There is a fault in the battery.	▶ Do not use the battery. Consult a STIHL dealer.	
The charger does not run a self test.	The LED glows green for about 1 second and then red for about 1 second.	Electrical contact to charger was briefly interrupted.	<ul style="list-style-type: none"> ▶ Disconnect the mains plug from the power supply. ▶ Wait for 1 minute. ▶ Insert the mains plug in a wall outlet.

18 Specifications

18.1 STIHL GTA 40.0 Garden Pruner

- Approved battery: STIHL AS
- Weight without battery, with guide bar and saw chain: 1.4 kg
- Max. oil tank capacity: 110 cm³ (0.10 l)
- Degree of protection: IPX4 (protection against splash water from any direction)

For runtime, see www.stihl.com/battery-life.

18.2 Chain Sprockets

The following chain sprockets may be used:

- 6-tooth for 1/4" P
 - Maximum chain speed: 8.0 m/s

18.3 Minimum groove depth of guide bars

The minimum groove depth depends on the pitch of the guide bar.

- 1/4" P 4 mm

18.4 STIHL AS battery

- Battery technology: lithium-ion
- Voltage: 10.8 V
- Maximum voltage: 12 V
- Capacity in Ah: See rating label
- Energy content in Wh: see rating label
- Weight in kg: See rating label

18.5 STIHL AL 5-2 Charger

- Rated voltage: see the rating plate
- Frequency: see rating plate
- Rated power: see rating plate
- Charging current: See the rating plate
- Maximum capacity of the approved STIHL AS battery: 12.5 Ah

For charging times, see www.stihl.com/charging-times.

18.6 Extension Cords

If an extension cord is used, the cross sectional area of its conductors must meet the following minimum requirements – depending on the line voltage and length of the extension cord:

If rated voltage on the rating label is 220V to 240V:

- Cord length up to 20 m: AWG 15 / 1.5 mm²
- Cord length 20 m up to 50 m: AWG 13 / 2.5 mm²

If rated voltage on the rating label is 100V to 127V:

- Cord length up to 10 m: AWG 14 / 2.0 mm²
- Cord length 10 m up to 30 m: AWG 12 / 3.5 mm²

18.7 Temperature limits

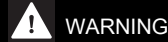

WARNING

- The battery is not protected against all ambient conditions. If the battery is exposed to certain environmental conditions, it may catch fire or explode. This may result in serious injury to people and damage to property.
 - ▶ Do not charge the battery below -20°C or above 50°C.
 - ▶ Do not use the garden pruner, battery or charger below -20 °C or above +50 °C.
 - ▶ Do not store the garden pruner, battery or charger below -20°C or above +70°C.

18.8 Recommended temperature ranges

For optimum performance of the garden pruner, batteries and charger, observe the following temperature ranges:

- Charging: 5°C to 40°C
- Use: - 10 °C to + 40 °C
- Storage: - 20 °C to + 50 °C

If the battery is charged, used or stored outside the recommended temperature ranges, performance may be reduced.

If the battery is wet or damp, allow the battery to dry for at least 48 h between 15°C and 50°C and with less than 70% humidity. Higher humidity may extend the drying time.

18.9 Sound and vibration values

STIHL recommends wearing hearing protection.

- Sound pressure level L_{pA} measured according to EN 62841-4-1: 82 dB(A), uncertainty K_{pA} : 2 dB(A)
- Sound power level L_{wA} , measured according to EN 62841-4-1: 90 dB(A), uncertainty K_{wA} : 2 dB(A)
- Guaranteed sound power level L_{wAd} measured according to 2000/14/EC: 92 dB(A).
- Vibration value a_{hv} measured according to EN 62841-4-1:
 - Control handle: 4.2 m/s², uncertainty K_a : 2.0 m/s²
 - Grip: 4.5 m/s², uncertainty K_a : 2.0 m/s²

- Vibration value p_F determined according to EN ISO 5349-3:
 - Control handle: 142 m/s², uncertainty K_p : 50 m/s²
 - Grip: 251 m/s², uncertainty K_p : 50 m/s²

The sound and vibration values indicated were measured according to a standardized test method and can be used as a basis for comparing electric power tools. The actual sound and vibration levels may vary from the values indicated, depending on the type of application and the accessories used. The sound and vibration levels indicated can be used for an initial estimate of the sound and vibration load. The actual sound and vibration stress has to be estimated.

19 Bar and Chain Combinations

19.1 STIHL GTA 40.0 Garden pruner

Pitch	Drive link gauge/groove width	Length	Guide bar	Number of teeth, sprocket nose	Number of drive links	Saw chain
1/4" P	1.1 mm	15 cm	Light 01	8	38	71 PM3 (Model 3670)
1/4" P	1.1 mm	20 cm	Light 01	8	44	71 PM3 (Model 3670)
1/4" P	1.1 mm	15 cm	Light S	-	38	71 PM3 (Model 3670)

The cutting length of a guide bar depends on the garden pruner used and the saw chain. The actual cutting length of a guide bar may be less than the specified length.

20 Spare Parts and Accessories

20.1 Spare parts and accessories

STIHL  These symbols indicate original STIHL spare parts and original STIHL accessories.

STIHL recommends the use of original STIHL spare parts and accessories.

Despite ongoing market observation, STIHL is unable to judge the reliability, safety and suitability of other manufacturers' spare parts and accessories; accordingly, STIHL cannot warrant for the use of those parts.

Original STIHL spare parts and original STIHL accessories are available from STIHL dealers.

21 Disposal

21.1 Disposing of Garden Pruner, Battery and Charger

Contact the local authorities or your STIHL dealer for information on disposal.

Improper disposal can be harmful to health and pollute the environment.

- ▶ Take STIHL products including packaging to a suitable collection point for recycling in accordance with local regulations.
- ▶ Do not dispose with domestic waste.

22 EU conformity

The EU Declaration of Conformity is available at stihl.link/compliance.

Further information and a form for reporting security vulnerabilities are available at vdp.stihl.com.

23 Addresses

www.stihl.com

24 General Power Tool Safety Warnings

24.1 Introduction



WARNING

- **Read all safety warnings, instructions, illustrations and specifications provided with this power tool.** Failure to follow all instructions listed below may result in electric shock, fire and/or serious injury. **Save all warnings and instructions for future reference.**

The term "electric power tool" in the safety warnings refers to mains-operated (corded) power tools or battery-operated (cordless) power tools.

24.2 Work area safety

- a) **Keep work area clean and well lit.** Cluttered or dark areas invite accidents.
- b) **Do not operate power tools in explosive atmospheres, such as in the presence of flammable liquids, gases or dust.** Power tools create sparks which may ignite the dust or fumes.
- c) **Keep children and bystanders away while operating a power tool.** Distractions can cause you to lose control.

24.3 Electrical safety

- a) **Do not expose power tools to rain or wet conditions.** Water entering a power tool will increase the risk of electric shock.

24.4 Personal safety

- a) **Stay alert, watch what you are doing and use common sense when operating a power tool. Do not use a power tool while you are tired or under the influence of drugs, alcohol or medication.** A moment of inattention while operating power tools may result in serious personal injury.
- b) **Use personal protective equipment. Always wear eye protection.** Protective equipment such as a dust mask, non-skid safety shoes, hard hat or hearing protection used for appropriate conditions will reduce personal injuries.
- c) **Prevent unintentional starting. Ensure the switch is in the off-position before connecting to power source and/or battery pack, picking up or carrying the tool.** Carrying power tools with your finger on the switch or energising

power tools that have the switch on invites accidents.

- d) **Remove any adjusting key or wrench before turning the power tool on.** A wrench or a key left attached to a rotating part of the power tool may result in personal injury.
- e) **Do not overreach. Keep proper footing and balance at all times.** This enables better control of the power tool in unexpected situations.
- f) **Dress properly. Do not wear loose clothing or jewellery. Keep your hair and clothing away from moving parts.** Loose clothes, jewellery or long hair can be caught in moving parts.
- g) **If devices are provided for the connection of dust extraction and collection facilities, ensure these are connected and properly used.** Use of dust collection can reduce dust-related hazards.
- h) **Do not let familiarity gained from frequent use of tools allow you to become complacent and ignore tool safety principles.** A careless action can cause severe injury within a fraction of a second.

24.5 Power tool use and care

- a) **Do not force the power tool. Use the correct power tool for your application.** The correct power tool will do the job better and safer at the rate for which it was designed.
- b) **Do not use the power tool if the switch does not turn it on and off.** Any power tool that cannot be controlled with the switch is dangerous and must be repaired.
- c) **Disconnect the plug from the power source and/or remove the battery pack, if detachable, from the power tool before making any adjustments, changing accessories, or storing power tools.** Such preventive safety measures reduce the risk of starting the power tool accidentally.
- d) **Store idle power tools out of the reach of children and do not allow persons unfamiliar with the power tool or these instructions to operate the power tool.** Power tools are dangerous in the hands of untrained users.
- e) **Maintain power tools and accessories. Check for misalignment or binding of moving parts, breakage of parts and any other condition that may affect the power tool's operation. If damaged, have the power tool repaired before use.** Many accidents are caused by poorly maintained power tools.

- f) **Keep cutting tools sharp and clean.** Properly maintained cutting tools with sharp cutting edges are less likely to bind and are easier to control.
- g) **Use the power tool, accessories and tool bits etc. in accordance with these instructions, taking into account the working conditions and the work to be performed.** Use of the power tool for operations different from those intended could result in a hazardous situation.
- h) **Keep handles and grasping surfaces dry, clean and free from oil and grease.** Slippery handles and grasping surfaces do not allow for safe handling and control of the tool in unexpected situations.

24.6 Battery tool use and care

- a) **Recharge only with the charger specified by the manufacturer.** A charger that is suitable for one type of battery pack may create a risk of fire when used with another battery pack.
- b) **Use power tools only with specifically designated battery packs.** Use of any other battery packs may create a risk of injury and fire.
- c) **When battery pack is not in use, keep it away from other metal objects, like paper clips, coins, keys, nails, screws or other small metal objects, that can make a connection from one terminal to another.** Shorting the battery terminals together may cause burns or a fire.
- d) **Under abusive conditions, liquid may be ejected from the battery; avoid contact. If contact accidentally occurs, flush with water. If liquid contacts eyes, additionally seek medical help.** Liquid ejected from the battery may cause irritation or burns.
- e) **Do not use a battery pack or tool that is damaged or modified.** Damaged or modified batteries may exhibit unpredictable behaviour resulting in fire, explosion or risk of injury.
- f) **Do not expose a battery pack or tool to fire or excessive temperature.** Exposure to fire or temperature above 130 °C may cause explosion.
- g) **Follow all charging instructions and do not charge the battery pack or tool outside the temperature range specified in the instructions.** Charging improperly or at temperatures outside the specified range may damage the battery and increase the risk of fire.

24.7 Service

- a) **Have your power tool serviced by a qualified repair person using only identical replacement parts.** This will ensure that the safety of the power tool is maintained.
- b) **Never service damaged battery packs.** Service of battery packs should only be performed by the manufacturer or authorized service providers.

24.8 Garden Pruner Safety Warnings

General Garden Pruner Safety Warnings

- a) **Keep all parts of your body away from the saw chain when the garden pruner is operating. Before you start the garden pruner, make sure the saw chain does not touch anything.** A moment of inattention while operating garden pruner may cause entanglement of your clothing or body with the saw chain.
- b) **Always hold the garden pruner with one hand on the rear handle and the other hand on the auxiliary handle.**
- c) **Hold the garden pruner by insulated gripping surfaces only, because the saw chain may contact hidden wiring or its own cord.** Saw chains contacting a "live" wire may make exposed metal parts of the garden pruner "live" and could give the operator an electric shock.
- d) **Wear eye protection. Further protective equipment for hearing, head, hands, legs and feet is recommended.** Adequate protective equipment will reduce personal injury from flying debris or accidental contact with the saw chain.
- e) **Do not operate a garden pruner on a ladder, from a rooftop, or any unstable support.** Operation of a garden pruner in this manner could result in serious personal injury.
- f) **Do not operate a garden pruner in a tree unless you have been specifically trained to do so.** Operation of a garden pruner in a tree without proper training could increase the risk of serious personal injury.
- g) **Always keep proper footing and operate the garden pruner only when standing on a fixed, secure and level surface.** Slippery or unstable surfaces may cause a loss of balance or control of the garden pruner.

- h) **When cutting a limb that is under tension be alert for spring back.** When the tension in the wood fibers is released the spring loaded limb may strike the operator and/or throw the garden pruner out of control.
- i) **Use extreme caution when cutting brush and saplings.** The slender material may catch the saw chain and be whipped toward you or pull you off balance.
- j) **Carry the garden pruner with the garden pruner switched off and away from your body. When transporting or storing the garden pruner, always fit the guide bar cover.** Proper handling of the garden pruner will reduce the likelihood of accidental contact with the moving saw chain.
- k) **Follow the instructions for lubricating, chain tensioning and changing the bar and chain.** Improperly tensioned or lubricated garden pruner may either break or increase the chance for injury.
- l) **Cut wood only. Do not use garden pruner for purposes not intended. For example: do not use garden pruner for cutting metal, plastic, masonry or non-wood building materials.** Use of the garden pruner for operations different than intended could result in a hazardous situation.
- m) **This garden pruner is not intended for tree felling.** Use of the garden pruner for operations different than intended could result in serious injury to the operator or bystanders.
- n) **Follow all instructions when clearing jammed material, storing or servicing the garden pruner. Make sure the switch is off and the battery pack is removed.** Unexpected actuation of the garden pruner while clearing jammed material or servicing may result in serious personal injury.

24.9 Causes and operator prevention of kickback

- a) **Maintain a firm grip, with thumbs and fingers encircling the garden pruner handles, with both hands on the garden pruner and position your body and arm to allow you to resist kickback forces.** Kickback forces can be controlled by the operator if proper precautions are taken. Do not let go of the garden pruner.
- b) **Do not overreach and do not cut above shoulder height.** This helps prevent unintended tip contact and enables better control of the garden pruner in unexpected situations.

www.stihl.com



0458-054-0101-B



0458-054-0101-B